

JUNE 1951

RADIO — ELECTRONICS

LATEST IN TELEVISION • SERVICING • AUDIO

HUGO GERNSBÄCK, Editor



30¢
U.S. and
CANADA

THE ELECTRIC VOICE — SEE AUDIO SECTION

**In this issue: New Television Booster •
Handling Test Leads • Rico Amplifier**

You get all five...with RCA Batteries



PERMANENT DISPLAY SIGN

Here's an 8 by 20 inch display sign providing triple sales impact for counter or window. Helps you sell Portable Radios, Radio Service, and RCA Batteries.

1. Top Brand Acceptance

2. Unique Selling Aids

3. Radio Trade Distribution

4. Completely Rounded Line

5. Radio-Engineered quality



**RCA BATTERY
FACT-FINDER**

A fast answer to quick battery sales. Just set index pointer, press the release—and the Fact-Finder opens with the battery information you want before you. Contains prices, techni-

cal data on the complete RCA line, interchangeability directory, and the Battery complement of 590 portable radios of 32 manufacturers...always at your fingertips.

RCA is *first* with the greatest array of selling aids in the field . . . *all geared to the radio trade.*

And . . . *the selling power* of the RCA Trade-Mark makes it *easy* for you to move RCA Batteries. You gain a satisfied customer every time.

Remember, too, that RCA Batteries are *radio-engineered* for *extra* listening hours . . . with a type for practically every renewal requirement.

So—starting now—push RCA Batteries. Build a profitable repeat business with virtually no competition from non-radio outlets.



**ILLUMINATED
GIANT BATTERY
DISPLAY**

A flashing beacon that attracts battery sales. Stands 12" high—comes complete with bulb, 6' cord, and detachable flasher-unit.

**INTERCHANGEABLE
TYPES
AUTOMATIC
PENCIL**

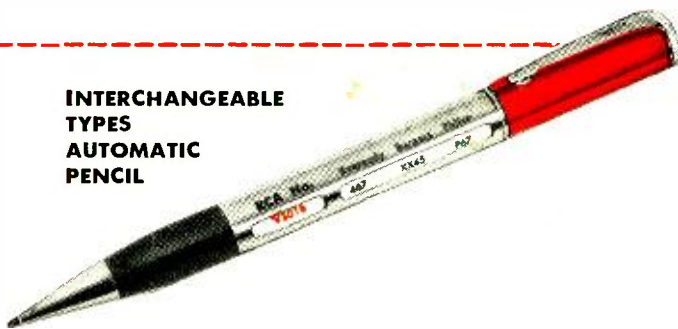

Revolving mid-section tells at a glance the stock numbers on the ten fastest-moving, interchangeable types of four leading battery brands . . . the types that comprise 85% of your interchangeability problems!

Learn how you can get these selling aids at no cost to you by contacting your RCA Battery Distributor today!



RADIO CORPORATION of AMERICA

RADIO BATTERIES

HARRISON, N. J.

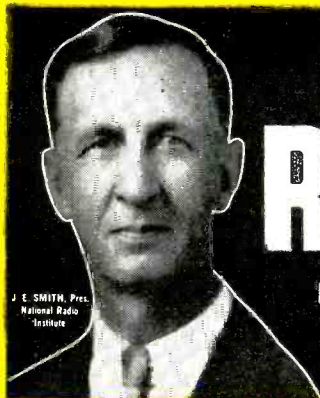

BE A SUCCESS AS A RADIO-TELEVISION TECHNICIAN

2 FREE BOOKS SHOW HOW MAIL COUPON

America's Fast Growing Industry Offers You

Available to VETERANS under G.I. Bill

1. EXTRA MONEY IN SPARE TIME

Many students make \$5, \$10 a week extra fixing neighbors' Radios in spare time while learning. The day you enroll I start sending you SPECIAL BOOKLETS to show you how to do this. Tester you build with parts I send helps you service sets. All equipment is yours to keep.

2. GOOD PAY JOB

Your next step is a good job installing and servicing Radio-Television sets or becoming boss of your own Radio-Television sales and service shop or getting a good job in a Broadcasting Station. Today there are over 90,000,000 home and auto Radios. 3100 Broadcasting Stations are on the air. Aviation and Police Radio, Micro-Wave Relay, Two-Way Radio are all expanding, making more and better opportunities for servicing and communication technicians and FCC licensed operators.

3. BRIGHT FUTURE

And think of the opportunities in Television! In 1950 over 5,000,000 Television sets were sold. By 1954 authorities estimate 25,000,000 Television sets will be in use. Over 100 Television Stations are now operating, with experts predicting 1,000. Now is the time to get in line for success and a bright future in America's fast-growing industry. Be a Radio-Television Technician. Mail coupon for Lesson and Book—FREE.



I TRAINED THESE MEN

<p>Chief Engineer, Police Radio Soon after making the N. R. I. course, worked for servicing shop. Now I am Chief Engineer of WGN, WSPK, two-way FM Police Radio installations. S. W. DUNN, Jacksonville, Ill.</p>	<p>Shop Specialist in Television Have my own shop. An authorized serviceman for 5 large manufacturers and do servicing for 7 dealers. N. R. I. has enabled me to build an enviable reputation in Television. J. MILLER, Maumee, O.</p>
<p>Over 100 Month Spare Time When I enrolled, had no idea it would be so easy to learn. Have equipped my shop out of spare time earnings. I am clearing about \$10.00 a month. Full credit to N. R. I. J. D. KNIGHT, Denton, Texas.</p>	<p>110 Grad and Double Salary Am with Station WKBO a transmitter operator. Have more than double salary, unexcused in Radio. Future looks bright. N. R. I. has been a real help to me. A. HERR, New Cumberland, Pa.</p>
<p>110 Week in Spare Time Before finishing your course, I earned as much as \$10 a week in Radio servicing, at home in my spare time. I recommend N. R. I. to everyone who shows interest in Radio. S. J. PETERSON, Miami, Fla.</p>	<p>Years of Success with Shop I operate my own shop and have over 500 customers. My profits average about \$2.00 a month. Have had years of successful experience and I still praise N. R. I. training. J. L. ANDERSON, Atlanta, Ga.</p>
<p>Best First Job Through N. R. I. My first job was operator with KDLR obtained for me by your Graduate Service Dept. I am now Chief Engineer of Police Radio Station WQOX. T. S. KOH, TON, Hamilton, Ohio.</p>	<p>Rejoice Now! Earning Better "Am proud of my diploma. I cannot say enough for the N. R. I. course. Regret I didn't take it years ago when I used to sweep-out-ade. Now I have a spare time 'shop." FRANK S. TUCKER, Hinton Village, Va.</p>

I Will Train You at Home

Read How You Practice Servicing or Communications with Many Kits of Parts You Get!



YOU BUILD this modern Radio (above) as part of my Servicing Course. Build this complete, powerful Radio Receiver that brings in local and distant stations. N. R. I. gives you ALL the Radio parts—speaker, tube, glass, transformer, sockets, loop antenna. EVERYTHING you need. You use material to get practical Radio experience. Make EXTRA money fixing neighbors' Radios in spare time while training.

YOU MEASURE current, voltage (AC, DC and RF), resistance and impedance in circuits with E. retro. Multimeter (above right) you build as part of my Servicing or Communications Course.

YOU BUILD the Transmitter (right). As part of my Communications Course, SEND YOU parts to build this low-power broadcasting transmitter. You learn how to put a station "on the air," perform procedures demanded of Broadcast Station operators, make many practical tests.

YOU BUILD this Wavemeter (below) in my Communications Course with parts I send you. Use it to determine frequency of operation and make other tests on transmitter currents. You conduct many interesting experiments.

This is just part of the equipment my students build. You keep all parts I send.

NOW! Advanced Television Practice

New, special TV kits furnished to build high-definition SCOPE . . . RF OSCILLATOR with flyback power supply . . . complete TV set . . . many other units. You see pulse, tropoidal, saw-tooth wave forms. Get valuable PRACTICAL EXPERIENCE locating and correcting TV troubles. Pictures and coupon for parts.

Keep your job while training at home. Hundreds I've trained are successful RADIO-TELEVISION TECHNICIANS. Most had no previous experience; many no more than grammar school education. Learn Radio-Television principles from illustrated lessons. Get PRACTICAL EXPERIENCE—build valuable Electronic Multimeter for conducting tests; also practice servicing Radios or operating Transmitters—experiment with circuits common to Radio and Television. At left is just part of the equipment my students build with many kits of parts I furnish. All equipment is yours to keep. Many students make \$5, \$10 a week extra fixing neighbors' Radios in spare time.

Mail Coupon For 2 Books FREE

Act Now! Send for my FREE DOUBLE OFFER. Coupon entitles you to actual lesson on Servicing; shows how you learn Radio-Television at home. You'll also receive my 64-page book, "How to Be a Success in Radio-Television." You'll read what my graduates are doing, earning; see photos of equipment you practice with at home. Send coupon in envelope or paste on postal card.

J. E. SMITH, Pres., Dept. 1FF, National Radio Institute, Washington 9, D. C. . . . Our 38th year.

Good for Both—FREE

Mr. J. E. SMITH, President, Dept. 1FF
National Radio Institute, Washington 9, D. C.

Mail me Sample Lesson and 64-page Book about How to Win Success in Radio-Television. Both FREE. (No salesman will call. Please write plainly.)

Name..... Age.....

Address.....

City..... Zone..... State.....

Check if Veteran Approved Under G. I. Bill



RADIO - ELECTRONICS

Incorporating
SHORT WAVE CRAFT* TELEVISION NEWS*
RADIO & TELEVISION
*Trademark registered U. S. Patent Office

formerly RADIO-CRAFT

MEMBER
AUDIT BUREAU OF CIRCULATIONS

Hugo Gernsback, Editor-in-Chief

M. Harvey Gernsback, Editorial Director

Fred Shunaman, Managing Editor

Robert F. Scott, W2PWG, Technical Editor
I. Queen, Editorial Associate

Angie Pascale, Production Manager
Wm. Lyon McLaughlin, Tech. Illustration Director

Lee Robinson, General Manager
John J. Lamson, Sales Manager

G. Aliquo, Circulation Manager
Robert Fallath, Promotion Manager

CONTENTS

JUNE, 1951

Editorial: Bio-Electronics.....	by Hugo Gernsback	23
Broadcasting and Communications (Pages 24-27)		
G-String Transmission and Helical Wave Coils	by Samuel Freedman	24
Wired Wireless Covers Campus....	by Richard H. Van Haagen	26
Television (Pages 28-33)		
Television Service Clinic.....	by Walter H. Buchsbaum	28
TV DX—A Prediction of what to Expect during June		29
Home-Built Booster Increases TV Range.....	by "Doc" Gaines	30
TV Relay with PCM	by I. Queen	31
TV Trouble Lexicon	by John B. Ledbetter	32
Electronics (Pages 34-39)		
LC Comparator Aids Industry.....	by James R. Cornelius	34
Crystal Spots Radiation.....		35
How an Electronic Brain Works, Part IX	by Edmund C. Berkeley and Robert A. Jensen	38
Servicing—Test Instruments (Pages 40-44)		
Don't Touch Those Screws!.....	by John D. Burke	40
With the Technician		42
Tubeless Oscillator Covers Audio to 2 mc	by Edwin Bohr and Hal French	43
Handling Test Leads	by H. Leeper	44
Audio (Pages 45-55)		
Electronics and Music, Part XII.....	by Richard H. Dorf	45
Experimenter's Power Supply.....	by Frank A. Graulich	47
Rico Amplifier.....	by Jacinto Sugranes	48
Audio Feedback Design, Part VIII..	by George Fletcher Cooper	51
Audio V.T.V.M. Measures Millivolts		53
Electric Voice (Cover Feature).....	by Eric Leslie	54
New Design (Pages 56-60)		
U.H.F. is the Keynote of Annual I.R.E. Show.....		56
New Tubes		60
Amateur (Pages 62-71)		
Four-Band CW Transmitter.....	by I. Queen	62
Cut QRM with Noise Limiters..	by Alvin B. Kaufman, WØYOV	66
Construction (Pages 72-77)		
U.H.F. Mystery Meter.....	by H. W. Secor	72
Automatic Porch Light Guards House at Night	by John T. Frye	74
Field Strength Meter Covers V.H.F. Range	by Hardin G. Stratman	76
TV Linearity Checker.....		77
Miscellany (Pages 95-103)		
The Radioman's Wife Puts in a Good Word	by Mrs. R. E. Altomare	95
Departments		
Radio Month.....	10	Radio Electronic
*Radio Business.....	14	Circuits
Question Box	78	New Devices.....
Try This One	83	Technotes
New Patents.....	86	People
		Communications ..
		108
Book Reviews.....	109	

ON THE COVER:

L. O. Schott of the Bell Telephone Laboratories operates the electric voice which is used by the Laboratories in speech research work. Kodachrome by Avery Slack

RADIO-ELECTRONICS, June 1951, Volume XXII, No. 9. Published monthly. Publications Office: Erie Ave., F to G Streets, Philadelphia 32, Pa. Entered as second class matter September 27, 1948, at the post office at Philadelphia, Pa. under the Act of March 3, 1879. **SUBSCRIPTION RATES:** In U. S. and Canada, in U. S. possessions, Mexico, South and Central American countries, \$3.50; \$6.00 for two years; \$8.00 for three years; single copies 30c. All other foreign countries \$1.50 a year, \$8.00 for two years, \$11.00 for three years. Allow one month for change of address. When ordering a change please furnish an address stencil impression from a recent wrapper. **RADCRAFT PUBLICATIONS, INC.** Hugo Gernsback, Pres.; M. Harvey Gernsback, Vice-Pres.; G. Aliquo, Sec'y. Contents copyright, 1951, by RADCraft Publications, Inc. Text and illustrations must not be reproduced without permission of copyright owners.

EDITORIAL and ADVERTISING OFFICES, 25 West Broadway, New York 7, N. Y. Tel. REctor 2-8630
BRANCH ADVERTISING OFFICES: Chicago: 520 N. Michigan Ave. Telephone Superior 7-1796. Los Angeles: Ralph W. Barker, 1127 Wilshire Blvd., Tel. MA 6-1271. San Francisco: Ralph W. Barker, 582 Market St., Tel. GARfield 1-2481. **FOREIGN AGENTS:** Great Britain: Atlas Publishing and Distributing Co., Ltd., London E.C.4. Australia: McGill's Agency, Melbourne. France: Brentano's, Paris 2e. Holland: Trillectron, Heemstede. Greece: International Book & News Agency, Athens. So. Africa: Central News Agency, Ltd., Johannesburg; Capetown; Durban, Natal. Natal. Universal Book Agency, Johannesburg. Middle East: Steimatzky Middle East Agency, Jerusalem. India: Broadway News Centre, Dadar, Bombay 214. K. L. Kannappa Mudaliar, Madras 2. Pakistan: Paradise Book Stall, Karachi 3. **POSTMASTER:** If undeliverable send form 3578 to: RADIO-ELECTRONICS, 25 West Broadway, New York 7, N. Y.

Use Sprague TELECAPS®
on TV replacement jobs.
Avoid costly callbacks!



Of course there's a reason why more Sprague Telecap molded tubular capacitors are used in leading television sets and by leading service shops than any other brand! Telecaps are especially designed for TV. They stand the gaff!

Write for Bulletin M-474

SPRAGUE
PRODUCTS COMPANY
DISTRIBUTORS' DIVISION OF THE SPRAGUE ELECTRIC COMPANY
81 MARSHALL ST., NORTH ADAMS, MASS.

RADIO-ELECTRONICS for



Learn RADIO

TELEVISION, ELECTRONICS

by

SHOP METHOD HOME TRAINING

Let NATIONAL SCHOOLS, of Los Angeles, a practical Technical Resident Trade School for almost 50 years, train you for today's unlimited opportunities.

You receive all parts, including tubes, for building this fine, modern Superheterodyne Receiver. This and other valuable standard equipment becomes yours, property.

these two FREE books will tell you how



WE BRING NATIONAL SCHOOLS TO YOU!

GOOD JOBS AWAIT THE TRAINED RADIO TECHNICIAN

You are needed in the great modern Radio, Television and Electronics industry! Trained technicians are in constant and growing demand at excellent pay—in Broadcasting, Communications, Television, Radar, Research Laboratories, Home Radio Service, etc. National Schools Master Shop Method Home Study Course, with newly added lessons and equipment, can train you in your spare time, *right in your own home*, for these exciting opportunities. Our method has been proved by the remarkable success of National Schools-trained men all over the world.

You Learn by Building Equipment with Standard Radio Parts We Send You

Your National Schools Course includes not only basic theory, but *practical* training as well—you *learn by doing*. We send you complete standard equipment of professional quality for building various experimental and test units. You advance step by step until you are able to build the modern superheterodyne receiver shown above, which is yours to keep and enjoy. You perform more than 100 experiments—build many types of circuits, signal generator, low power radio transmitter, audio oscillator, and other units. The Free Books shown above tell you more about it—send for them today!

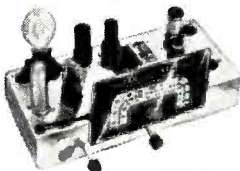

NOW! NEW PROFESSIONAL MULTITESTER INCLUDED

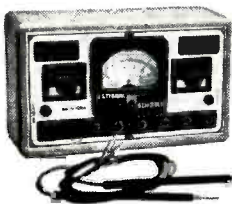

This versatile testing instrument is portable and complete with test leads. Simple to operate, accurate and dependable. You will be able to quickly locate trouble and adjust the most delicate circuits. You can use the Multitester at home or on service calls. It is designed to measure AC and DC volts, current resistance and decibels. You will be proud to own and use this valuable professional instrument.

GET THE DETAILS - SEND THE COUPON →

Lessons and Instruction Material Are Up-to-date, Practical, Interesting

National Schools Master Shop Method Home Training gives you basic and advanced instruction in all phases of Radio, Television and Electronics. Each lesson is made easy to understand by numerous illustrations and diagrams. All instruction material has been developed and tested in our own shops and laboratories, under the supervision of our own engineers and instructors. A free sample lesson is yours upon request—use the coupon below.

TELEVISION TRAINING A complete series of up-to-the-minute Television lessons is an integral part of your course, covering all phases of Television repairing, servicing and construction.

Here are just a few of the interesting facts you learn with the **FREE SAMPLE LESSON**

1. How radio receivers operate.
2. How the antenna circuit is constructed.
3. Converting signal currents into sound.
4. How the R-F transformer handles the signal.
5. How the tuning circuit functions.
6. The Radio "bands."

APPROVED FOR VETERANS
Check coupon below.

NATIONAL SCHOOLS

LOS ANGELES 37, CALIFORNIA EST. 1905



MAIL OPPORTUNITY COUPON FOR QUICK ACTION

National Schools, Dept. 6-RE
4000' South Figueroa Street
Los Angeles 37, California

(Mail in envelope or paste on penny postcard.)

Mail me FREE the book "Your Future in Radio-Television" and the sample lesson of your course. I understand no salesman will call on me.

NAME _____ AGE _____

ADDRESS _____

CITY _____ ZONE _____ STATE _____

Check here if veteran of World War II

Replacements and Conversions with **RAYTHEON** Television Tubes please everyone..

RAYTHEON TELEVISION PICTURE TUBES will please *you* because they are mechanically and electrically perfect. 101 basic quality tests, checks and inspections made during the various steps of a Raytheon Tube's construction — components, chemicals, processing, assemblies — assure unexcelled performance. You can make conversions and replacements with complete confidence that your skill plus RAYTHEON quality will result in superb picture reproduction.

Your customers will be delighted with Raytheons because they'll be receiving the finest TV picture they've ever seen. It will be a

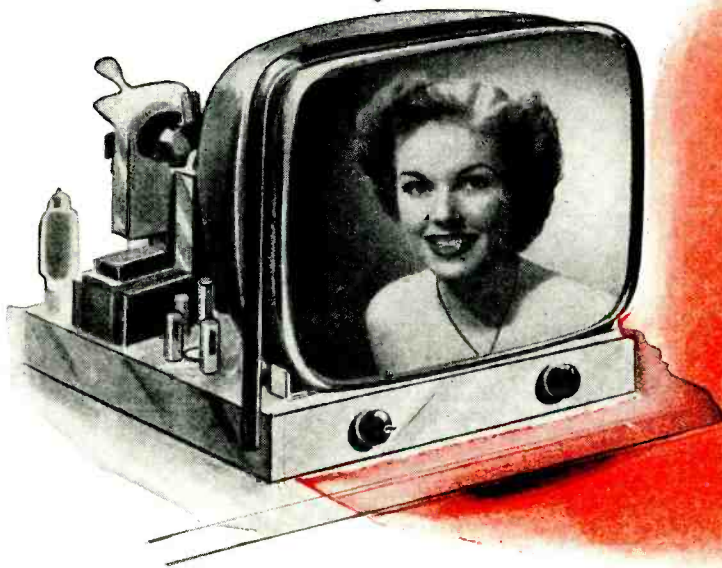

crisp, clear, contrasty, longer-lived picture — thanks to the superior quality of Raytheon Tubes — a quality that could only result from the knowledge gained through Raytheon's more than 25 years of experience in the pioneering and manufacture of all kinds of high fidelity electronic tubes.

Team your skill with Raytheon Quality.
You'll find it pays in many ways. See your
Raytheon Tube Distributor today.

Right for
Sight...



Excellence in Electronics

RAYTHEON MANUFACTURING COMPANY
Receiving Tube Division
Newton, Mass., Chicago, Ill., Atlanta, Ga., Los Angeles, Calif.

RADIO AND TELEVISION RECEIVING TUBES, CATHODE RAY TUBES, SPECIAL PURPOSE TUBES, SUBMINIATURE TUBES, MICROWAVE TUBES.
CORPORATION





Can You See Your Future in TV?

CREI HOME STUDY Shows You the Way to Greater Earnings in TELEVISION & FM SERVICING!

Servicemen with specialized, up-to-date television and FM training have a big advantage over those with AM knowledge only. It's true whether you are competing for jobs or making a go of your own repair business. CREI knows what you need—and provides it in this practical home-study servicing course. Every lesson is helpful in your daily work. Every lesson is revised as new developments in this fast-moving field occur. Lessons start with basic principles and go step-by-step through advanced trouble-shooting, time-saving techniques.

Qualified servicemen are getting harder and harder to find—at the very time that civilian needs are at their highest point. With mounting sales of TV sets—and hundreds of new TV stations in the offing—with the electronics industry expanding, and the growing

military demands cutting sharply into the available manpower—now is certainly the time to make the most of your opportunity.

Whether you're interested in improving your ability—and earning power—in servicing work, or in the expanding industrial electronics field, CREI home study pays off with more money, interesting jobs, and secure careers. Course cost is within reach of all, terms are easy. Write for free catalog now.

NOTE TO MEN who expect to be in uniform soon. *TV-electronics training puts you in line for work in vital radar, communications and navigation work in the Armed Services. Prepare now to qualify for higher ratings in uniform!*

THE THREE BASIC CREI COURSES:

- ★ **PRACTICAL RADIO ENGINEERING**
Fundamental course in all phases of radio-electronics
- ★ **PRACTICAL TELEVISION ENGINEERING**
Specialized training for professional radiomen
- ★ **TELEVISION AND FM SERVICING**
Streamlined course for men in "top-third" of field

ALSO AVAILABLE AS RESIDENCE SCHOOL COURSES

CAPITOL RADIO ENGINEERING INSTITUTE

An Accredited Technical Institute Founded in 1927
Dept. 146C, 16th & Park Rd., N. W. Washington 10, D. C.
Branch Office: San Francisco, 760 Market St.



MAIL COUPON FOR FREE BOOKLET

CAPITOL RADIO ENGINEERING INSTITUTE

Dept. 146C, 16th & Park Road, N. W., Washington 10, D. C.

Gentlemen: Send booklet, "Your Future in the New World of Electronics," together with details of your home study training. CREI self-improvement program and outline of course. I am attaching a brief resume of my experience, education and present position.

- Check Field of Greatest Interest:
- | | |
|---|---|
| <input type="checkbox"/> TV, FM & Advanced AM Servicing | <input type="checkbox"/> Aeronautical Radio Engineering |
| <input type="checkbox"/> Practical Television Engineering | <input type="checkbox"/> Broadcast Radio Engineering (AM, FM, TV) |
| <input type="checkbox"/> Practical Radio Engineering | <input type="checkbox"/> Radio-Electronics in Industry |
- If Residence School in Wash., D. C., Preferred, Check Here

NAME _____ AGE _____

ADDRESS _____

CITY _____ ZONE _____ STATE _____

It tells your
"RINGER"
when not to ring!

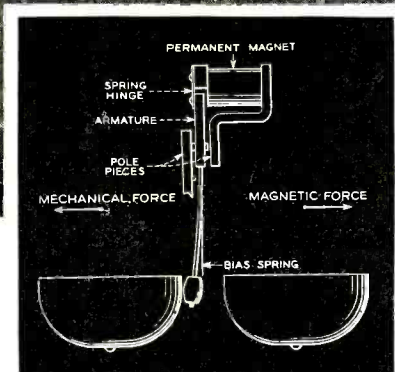
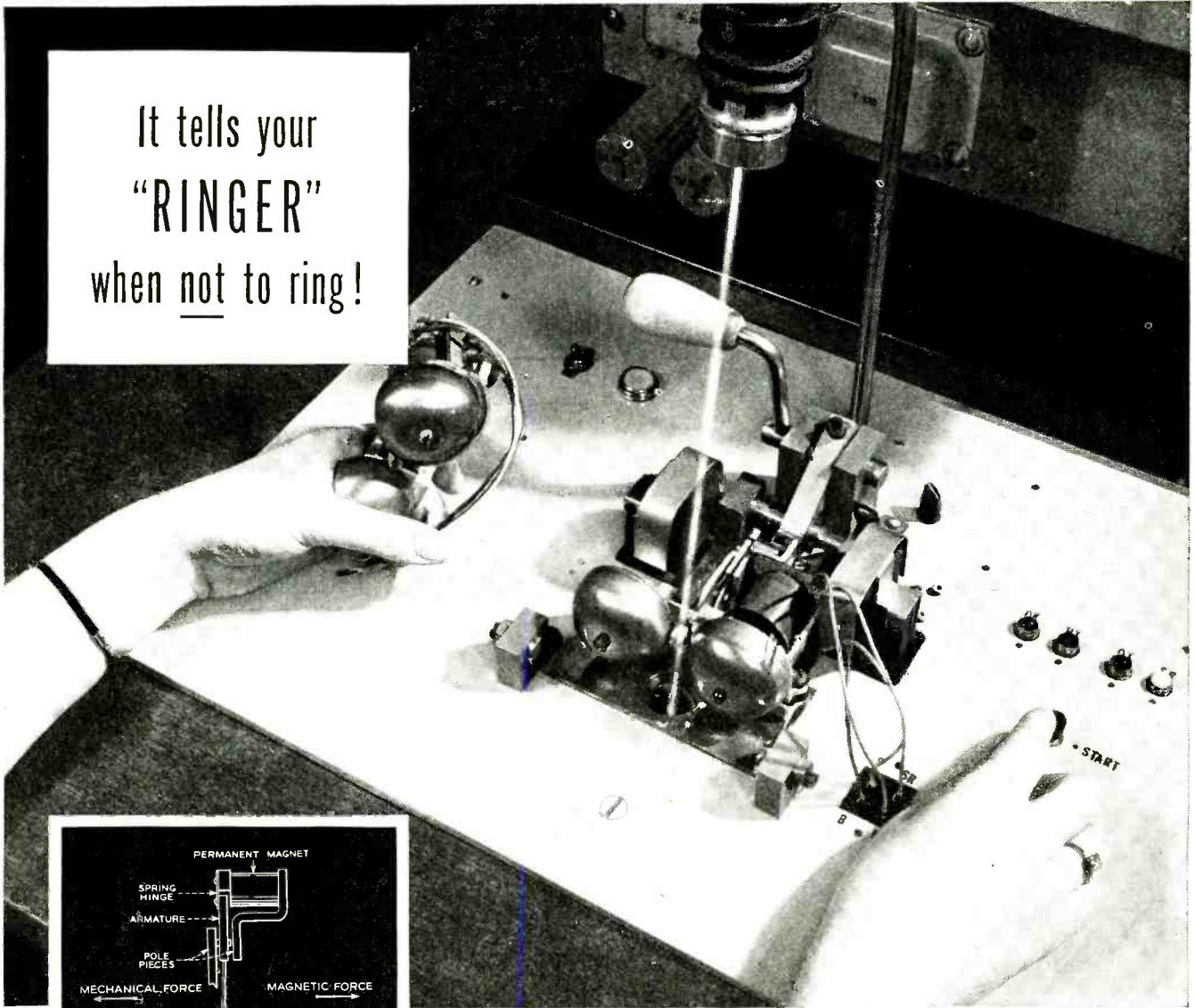

The Bell System's new automatic method of adjusting telephone ringers uses a beam of light passing between the gongs to a photoelectric cell. When test currents are applied to the ringer the machine decides whether to change the spring tension or the magnetic pull. After each change it tests again until the ringer is in perfect adjustment—and the whole procedure takes only 30 seconds.

To you, it's your familiar telephone bell. To telephone engineers, it's a "ringer." And it has two jobs to do. It must ring, of course, when someone calls you. And it must overlook the numerous electrical impulses which do not concern it, such as those sent out by your dial.

Ability to respond to some impulses, to ignore others, requires exact adjustment between the pull of a magnet and the tension of a spring. If they are out of balance your telephone might tinkle when it oughtn't, or keep silent when it should ring.

In the past, adjustment was made by hand, little by little until the proper setting was reached. It took time. But now Bell Laboratories engineers have developed a machine which adjusts new ringers perfectly, before they leave the Western Electric Company plants where they are made. And the operation takes just 30 seconds.

This is another example of how the Laboratories work constantly to improve every phase of telephony — keeping the costs low while the quality of service grows higher and higher.

BELL TELEPHONE LABORATORIES

WORKING CONTINUALLY TO KEEP YOUR TELEPHONE SERVICE ONE OF TODAY'S GREATEST VALUES



RADIO-ELECTRONICS for

**NOW... GET EVERYTHING YOU
NEED TO LEARN AND MASTER**

TELEVISION

**RADIO-ELECTRONICS
...AT HOME!**

Use REAL commercial-type equipment to get practical experience



**Here's the
REAL THING!**

**SET UP YOUR OWN
HOME LABORATORY**



Oscilloscope

R-F Signal
Generator

6-Tube
Radio

Multimeter

**HOME
MOVIES**

ABOVE: Build and keep a real 16 INCH commercial TV receiver. Optional after completing regular training at slight additional cost.

D.T.I., ALONE, INCLUDES BOTH MOVIES and HOME LABORATORY
In addition to easy-to-read lessons, you get the use of HOME MOVIES — an outstanding training advantage — plus 16 big shipments of Electronic parts. Perform over 300 fascinating experiments for practical experience. Build and keep real commercial-type test equipment shown at left.

MODERN LABORATORIES
If you prefer, get all your preparation in our new Chicago Training Laboratories — one of the finest of its kind. Ample instructors, modern equipment. Write for details!

MILITARY SERVICE!
If you're subject to military service, the information we have for you should prove doubly interesting. Mail coupon today.

**Get BOTH of these
information packed
publications FREE!**

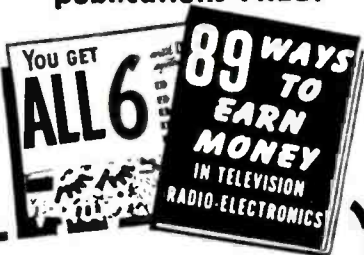

ACT NOW! MAIL COUPON TODAY!

DeFOREST'S TRAINING, INC., Dept. RE-6-H
2533 N. Ashland Ave., Chicago 14, Ill.

Without obligation, I would like your late News-Bulletin showing 89 ways to earn money in Television-Radio-Electronics ... and how I may prepare to get started in this thrilling field.

Name..... Age.....
Street..... Apt.....
City..... Zone..... State.....

De FOREST'S TRAINING, INC.
CHICAGO 14, ILLINOIS
A De VRY INSTITUTION



Optical comparator is used to check mica disc specifications to thousandth-inch accuracy.

ONE STANDARD

The best that can be made-for
Initial Equipment and Replacement



TUNG-SOL
 RADIO, TV TUBES, DIAL LAMPS



TUNG-SOL LAMP WORKS INC. Newark 4, N. J.
 Sales Offices: Atlanta • Chicago • Dallas • Denver • Detroit • Los Angeles • Newark

PREDICTING THE FUTURE from the motion of the planets, long the basis of the ancient pseudo-science of astrology, has emerged from the realm of superstition into the field of modern science. RCA engineer John H. Nelson, writing in the *RCA Review*, reports evidence that the magnetic storms on the earth which disrupt radio communications are directly related to the positions of the planets.

Engineer Nelson, also an amateur astronomer, was assigned years ago to the task of studying the spots on the sun through a 6-inch telescope set up for him on the roof of a downtown office building in New York City. He failed to find enough correlation between the sunspots and the behavior of radio communications to be able to make predictions of more than a few days in advance, and in 1948 caused some comment in astronomical circles by reporting that the size of the sunspots is a "meaningless criterion" in predicting radio disturbances. The type of sunspots, their age and activity, and their position on the sun are the determining factors.

Engineer Nelson turned to the planets for his research inspired by suggestions from the late Ellsworth Huntington of Yale and Henry Helm Clayton. He studied hundreds of daily propagation reports compiled by technicians at RCA's receiving station at Riverhead, L. I., and from overseas stations of Radio France and Sweden's Telegraph Administration. These he tried to correlate with the positions of the planets.

From these studies Mr. Nelson concluded that the planets disturb the sun; and the sun in turn affects electromagnetic conditions on the earth. From daily plots of the courses of the six inner planets he observed that disturbances on the earth occur more frequently when two or more planets form a right angle (with the sun as apex), or form a straight line with the sun.

The most disturbed periods are the twelve months preceding and following the positioning of Saturn and Jupiter in such a configuration. The most severe

disturbances occur when Mars, Venus, Mercury, and Earth are in critical relationship near points of the Saturn-Jupiter configuration. When Saturn and Jupiter have moved away from their configuration, the earth's magnetic activity decreases, although the smaller planets cause storms of shorter duration. The quietest periods occur when Saturn, Jupiter, and Mars are equally spaced around the sun by 120°. The figure shows the positions of the planets during the great 1946 magnetic storm.

Not all planetary configurations coincide with magnetic storms, but studies of the Riverhead records show that storms are about ten times more frequent during a configuration than on ordinary days.

Major disturbances can be predicted as much as two years in advance. By combining planetary observations with daily inspection of the sun's surface, Mr. Nelson has been able to predict good and bad radio weather with 85% accuracy or better.

MEDAL OF HONOR of the Institute of Radio Engineers was awarded to Dr. Vladimir K. Zworykin, vice-president and technical consultant of RCA Laboratories, Princeton, N. J. In his acceptance speech at the Institute's annual banquet at New York's Waldorf-Astoria, Dr. Zworykin stressed the importance of the role of electronics in the future of medicine, both in therapy and diagnosis. Close co-operation between physician and engineer is needed to work out these problems, he said.



AUTO TV SETS will be banned in New York state after July 1. A bill, signed without comment by Governor Thomas E. Dewey, provides: "It shall be unlawful to operate upon any public highway in this state a motor vehicle which is equipped with a television receiving set."

SHIP OPERATOR RULES have been changed somewhat by the FCC in an effort to relieve a serious shortage of manpower resulting from the expansion of the nation's merchant fleet. For the duration of the emergency, examination is waived for operators having less than two years of satisfactory service under the license being renewed. Another change establishes a temporary limited second-class license allowing the holder to operate radiotelegraph aboard ships only.

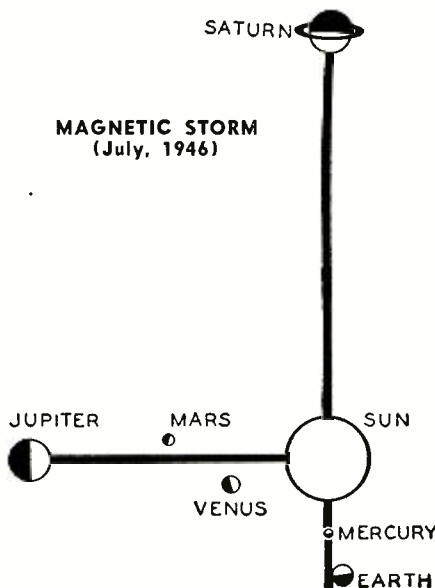

Which Do You Want?



Better Pay



A Nice Home

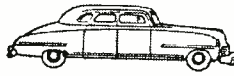

A New Car

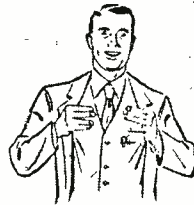

Greater Security



Happy Vacations and Travel

Get Your FCC Ticket Then Use Our Amazingly Effective Job-Finding Service To Get a Better Job



EDW. H. GUILFORD
Vice President

I can train you to pass your FCC License Exams in a minimum of time if you've had any practical radio experience—amateur, Army, Navy, radio servicing, or other. My time-proven plan can help put you, too, on the road to success. Just fill out the coupon and mail it. I will send you free of charge, a copy of "How to Pass FCC License Exams," plus a sample FCC-type Exam, and the amazing new booklet, "Money Making FCC License Information."

How to Pass FCC License Exams

Commercial Radio Operator



FREE

Tells where to apply for and take FCC examinations, location of examining offices, scope of knowledge required, approved way to prepare for FCC examinations, positive method of checking your knowledge before taking the examinations.

Get this Amazing Booklet FREE

TELLS HOW — WE GUARANTEE

TO TRAIN AND COACH YOU AT HOME IN SPARE TIME UNTIL YOU GET

YOUR FCC LICENSE

TELLS HOW — Employers make

JOB OFFERS Like These

to Our Graduates Every Month

Telegram, August 9, 1950, from Chief Engineer, Broadcast Station, Pennsylvania. "Have job opening for one transmitter operator to start immediately, contact me at once." Letter, August 12, 1950, from Dir. Radio Div. State Highway Patrol. "We have two vacancies in our Radio Communication Division. Starting pay \$200; \$250 after six months' satisfactory service. Will you recommend graduates of your school?" These are just a few examples of the job offers that come to our office periodically. Some licensed radioman filled each of these jobs . . . it might have been you!

HERE'S PROOF FCC LICENSES ARE OFTEN SECURED IN A FEW HOURS OF STUDY WITH OUR COACHING AT HOME IN SPARE TIME

Name and Address	License	Lessons
Lee Worthing 2210 1/2, Wishire St., Bakersfield, Cal.	2nd Phone	16
Clifford E. Vogt Box 1016, Dania, Fla.	1st Phone	20
Francis X. Foerch 38 Beucier Pl., Bergenfield, N. J.	1st Phone	38
S/Sgt. Ben H. Davis 317 North Roosevelt, Lebanon, Ill.	1st Phone	28
Albert Schaeff 110 West 11th St., Escondido, Cal.	2nd Phone	23

CLEVELAND INSTITUTE OF RADIO ELECTRONICS
Desk RE-30, 4900 Euclid Bldg., Cleveland 3, Ohio
(Approved for Veteran Training Under "GI Bill of Rights")

TELLS HOW —

Our Amazing Effective JOB-FINDING SERVICE

Gets Better Jobs for Graduates

Here is just one recent example of Job-Finding Results

OURS IS THE ONLY HOME STUDY COURSE WHICH SUPPLIES FCC-TYPE EXAMINATIONS WITH ALL LESSONS AND FINAL TESTS.

GETS FIVE JOB-OFFERS FROM BROADCAST STATIONS "Your 'Chief Engineer's Bulletin' is a grand way of obtaining employment for your graduates who have obtained their 1st class license. Since my name has been on the list, I have received calls or letters from five stations in the southern states, and am now employed as Transmitter Engineer at WMMT." Elmer Powell, Box 274, Sparta, Tenn.

Your FCC Ticket is always recognized in all radio fields as proof of your technical ability.



Get All 3 FREE

MAIL COUPON NOW

CLEVELAND INSTITUTE OF RADIO ELECTRONICS
Desk RE-30, 4900 Euclid Bldg., Cleveland 3, Ohio
(Address to Desk No. to avoid delay.)

I want to know how I can get my FCC ticket in a minimum of time. Send me your FREE booklet, "How to Pass FCC License Examinations" (does not cover exams for Amateur License), as well as a sample FCC-type exam and the amazing new booklet, "Money-Making FCC License Information."

NAME
ADDRESS
CITY ZONE STATE

Paste on penny post card or send air mail

Watch
MERIT
for TV in '51

Merit is meeting the rapidly rising demand for TV replacements with a TV line as complete as current and advance information will permit

TRY MERIT FIRST FOR TV CONVERSION OR REPLACEMENT!



HV06—Universal Ferrite core "FLYBACK" permits widest coverage.



MDF70—70° high efficiency Ferrite yoke for tubes up to 19"



MWC-1—Width linearity control with AGC winding (Automatic Gain Control).

FOCUS COILS



Free!

Write today for:

- MERIT TV REPL GUIDE AND CATALOG**
—Dec. 1950 issue. Up-to-date listing of all replacements.
- MERIT 1951 CATALOG No. 5111**
Show specs. on a complete line of TV, Radio, Amateur and Industrial Transformers.

REFER TO MERIT'S LISTING
in Howard Sam's Photofacts



TAPE-MARKED TO HELP YOU!

Handy tape marking on every Merit Transformer shows permanent hook-up data for quick reference. **ORIGINATED BY MERIT.**

MERIT
TRANSFORMER CORP.

4443 NORTH CLARK ST., CHICAGO 40, ILL.

FM BEEP SIGNALS, used by some FM broadcast stations to mute receivers during commercials and station announcements in restaurants and other public places, are not legal, according to a ruling by the FCC. A few FM stations have been using such signals to provide "functional music" programs to subscribers as a source of additional revenue. (See April, 1951 issue, p. 30.)

In a letter to four stations using the system, the FCC expressed sympathy with the aims of the broadcasters, but ruled that eliminating the station identification announcement violates the Communications Act. The commission further ruled that subscribers to such services must be logged as sponsors, and all such programs must be listed as commercial time periods. The stations involved—WRLD, Miami, Fla.; WACE-FM, Chicopee, Mass.; WFMF, Chicago, Ill.; and KDFC, Sausalito, Cal.—were ordered to show how they intend to comply with the order by April 30.

TELEVISION TRANSMITTER was presented as a gift to the Indiana Technical College, Fort Wayne, by the Zenith Radio Corporation, Chicago. The custom-designed unit first went into service in 1938 in Zenith's experimental station. Later it was used in Phonovision tests and has only recently been replaced by new equipment. The transmitter includes complete facilities for transmitting sound and picture on channel 2. An earlier gift by the Capehart-Farnsworth Corporation of the major portions of a TV transmitter gave the college's television engineering course its start.

WESTERN UNION is the latest comer to the television service ranks, it was announced in New York City recently. According to the announcement, a new subsidiary, Western Union Services, Inc., will open a pilot shop in East Orange, New Jersey, across the Hudson from New York City. The new company has an arrangement with Du Mont to install and service Du Mont receivers in three New Jersey counties, and at present will confine itself to the service of Du Mont teletests. Thomas F. McMains, president of the new company, explained that Western Union, backed by its 100 years of experience in the telegraph field, felt particularly capable of solving the problems likely to be encountered in the business of servicing electronic equipment such as television receivers.

The pilot plant is expected to have a staff of between 20 and 30 specially trained technicians and an adequate fleet of service vehicles. It will handle Du Mont installation and service work in Essex, Passaic, and Union Counties, at rates uniform with present Du Mont charges.

WILLIAM E. BEAKES, one of radio's pioneers and former president of the Tropical Radio Telegraph Company, died on March 30 at the age of 70. In 1941 Mr. Beakes was awarded the Marconi Wireless Pioneer Medal of the Veteran Wireless Operators Association for

his pioneering in radio in the North Atlantic and tropical zones. He took part in Marconi's first transatlantic radiotelegraph transmissions shortly after the turn of the century and later aided Professor Reginald Fessenden in wireless experiments. In 1912 he joined the United Fruit Company, which was then experimenting with radio in Central America. Mr. Beakes is credited with building up the Tropical Radio Telegraph Company, a subsidiary of United Fruit. Much of his work was devoted to the transition from long to short waves to overcome interference from tropical static.

ANTISUBMARINE TORPEDO that automatically "homes" on an enemy submarine either on the surface or at any depth to which it will submerge was disclosed by the Navy. The deadly high-speed missile operates on the same principle as similar homing torpedoes used successfully but to a limited extent during World War II, which were guided by the noise made by the enemy craft. The new weapon is at least twice as fast as the former one. A silent submarine trying to wait out an attack can be sought out by picking up reflections of sounds sent out by the torpedo itself. The torpedo would be equally effective against surface craft.

TELEVISION SCREENS may serve in place of windshields in supersonic planes of the future. The windshield is the only major projection from the surface of high-speed aircraft, and it creates objectionable friction and heat. Preliminary studies were made at the University of Illinois for the Navy to find out if it is feasible to use television. Dr. Stanley N. Roscoe, head of the project, said that a periscope was fitted to a Cessna plane for projection to an 8-inch screen in the pilot's compartment. The periscope allowed for various degrees of magnification. Pilots flew the plane with windows covered and uncovered, and found they could fly "just about as well" using the 8-inch screen with low magnification. Dr. Roscoe said he envisioned planes of the future with an optical system installed in the front of the craft, and a television screen in front of the pilot showing him what is ahead.

SECRET CONFERENCE was held by the FCC with more than 3,000 commercial broadcasters to give instructions on what to do and how to do it in the event of an air attack on the United States. Top experts of the air defense command outlined general instructions to the broadcasters, and it was assumed that this will be followed by top secret individual instructions to each owner of a broadcasting outlet. The part broadcasters will have in such a national emergency has not been announced, and probably will not be.

Some time ago the FCC said that it was issuing a series of unannounced permits for secret experiments involving the use of radio for national crisis. The nature of these tests has never been disclosed.

—end—



HOME STUDY COURSE in TELEVISION SERVICING

... based on the experience of the RCA Service Company

Now available to the Industry

Here's *your* golden opportunity to take the time-tested RCA Service Company course on television receiver servicing... to earn a valuable RCA Institutes' certificate that can lead straight to a better job at higher pay.

Now, for the first time, *you* can take the same basic course that has already been given to the thousands of RCA's own servicemen... an easy-to-understand home-study course based on the actual experience of the RCA Service Company in servicing thousands of home television receivers.

Cost is *low*... only \$9 a unit for 10 units or \$90 total, on an easy pay-as-you-learn plan. And value is *high*... the certificate of completion issued by RCA Institutes is known and honored throughout the radio-electronics industry.

Never before available to anyone outside RCA. Now offered to *you* through RCA Institutes, one of America's oldest and most respected technical training schools. Course covers most major makes and types of TV receivers. Designed specially for men already in electronics; therefore no kits

or paraphernalia are required. Handled entirely by correspondence. Available *exclusively* to men in the radio-television-electronics field. Not offered to the general public, or under the G.I. Bill.

ENROLL NOW! Mail the coupon *today*. Don't miss your great opportunity to take this proven course. If you're just getting started in TV, it will make you a *good* serviceman. If you're already *good*, it can't help but make you *better!* Send the coupon... get on the reservation list... **NOW!**

LOWER RATES FOR GROUPS!

If any employer in the radio-electronic industry desires to enroll six or more of his employees for this course, lower rates will apply. A special group application form is available for employers desiring to take advantage of this offer.



RCA INSTITUTES, INC.

A SERVICE OF RADIO CORPORATION of AMERICA
350 WEST FOURTH STREET, NEW YORK 14, N.Y.

MAIL COUPON TODAY!

RCA INSTITUTES, INC.
Home Study Department, RE-651
350 West Fourth Street
New York 14, N. Y.

Without obligation on my part, please reserve a place for me in your *home study course on television servicing* and send me full details. No salesman will call. I understand I must be employed in the radio-TV-electronics field to qualify for the course.

Name _____
(Please Print)

Address _____
(Street)

City _____ Zone _____ State _____

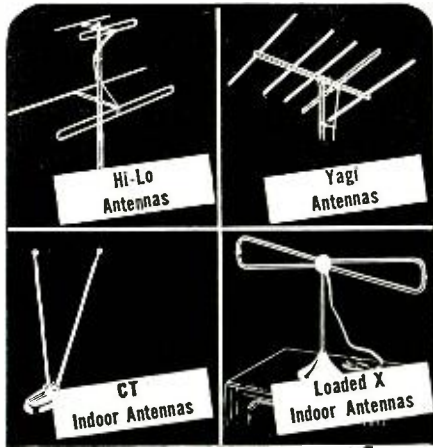

8 Good Reasons for you to CHOOSE CORNELL-DUBILIER Skyhawk TV ANTENNAS

One of the reasons for the splendid acceptance of C-D SKYHAWK antennas is the completeness of the line. Whatever the application... whatever the situation... THERE IS A CORRECT C-D ANTENNA FOR EVERY NEED. No need to accept inferior makes or substitute types when the C-D antenna line offers a full variety... each doing a specific job... BETTER!

CORNELL-DUBILIER ELECTRIC CORP.
SOUTH PLAINFIELD, NEW JERSEY

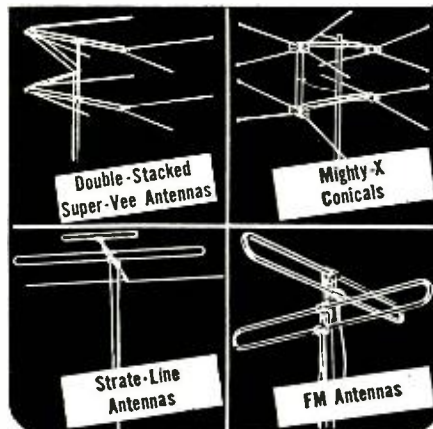

Merchandising & Promotion

RCA has launched a full-scale radio battery promotion stressing that RCA battery sales are made exclusively through radio trade channels. Timed for the opening of the spring-summer portable radio season but keyed to year-round selling, the drive features spot announcements on RCA radio and TV shows urging the purchase of radio bat-



teries from service technicians and dealers. Point-of-purchase displays will also be used extensively. Two unique sales and servicing aids have been developed for dealer use, the RCA battery "fact-finder" index and a mechanical pencil which shows interchangeable types of batteries. These selling aids are available free with the purchase of RCA batteries from distributors.

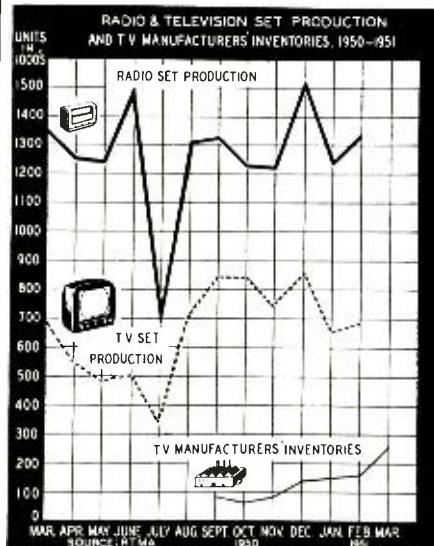

Walter L. Schott Co. is celebrating its twelfth anniversary with a gift offer of a kit containing five Walsco products for service technicians. The kit will be



given away free with every \$2.00 purchase of Walsco hardware, chemicals, or accessories, or every \$10.00 purchase of Walsco antennas, during the months of June and July. The offer is available through distributors.

Television Supply Co. of New York City issued a new eight-page antenna and accessory folder which is suitable for mailing.

General Electric Tube Divisions' Advertising Manager, G. A. Bradford, announced a national TV picture tube promotion aimed at the 12-inch tube replacement market. National consumer magazines, radio and television and dealer helps are being used. An illustrated loose-leaf booklet, "Tele-Clues" which aids service technicians in localizing TV circuit defects is included in the promotion.

General Electric has issued a two-color catalog sheet describing its new civil defense receiver. The sheet gives complete specifications of the receiver, which is intended for two-way radio systems.

Jackson Electrical Instrument Co., Dayton, has issued a "Bulletin" holder free to distributors. The holder permits distributors to display data on new tubes in the interim period until a complete new roll chart on tube data is available.

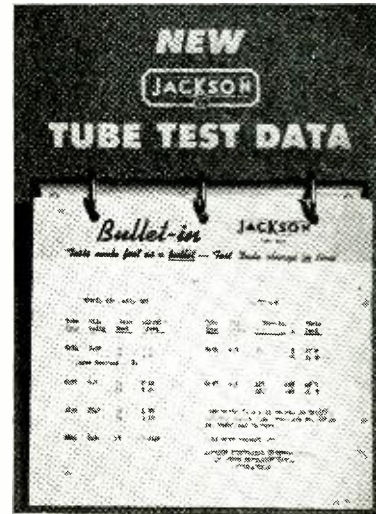

National Union Radio Corp. is offering a new durable indoor fluorescent sign to service technicians and dealers. Steel



constructed with a gold-bronze finish, the sign may either be hung by chains or displayed on the counter. It is available from distributors at the non-profit price of \$8.95 plus shipping charges.

Sprague Products Co. introduced a new double-purpose package, holding five Telecap molded tubular capacitors of the same value. The new "Domepak"

With every \$2.00 purchase of WALSCO products or \$10.00 worth of antennas.

it's **FREE!**

WALSCO 12th ANNIVERSARY GIFT package

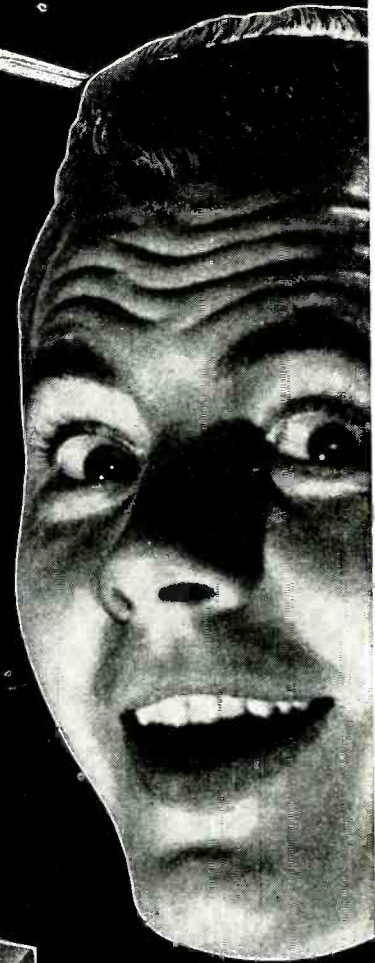

...all YOURS!

- WALSCO LUBRICATOR
- WALSCO CONTACTENE INJECTOR
- WALSCO TUNERLUB
- WALSCO NO-OX
- WALSCO CEMENT



\$2.00 value FREE

with every \$2.00 purchase of WALSCO products... or \$10.00 worth of WALSCO antennas.

A TERRIFIC FREE OFFER!

Each item in this attractive GIFT package will be useful to you. And it's yours at *no extra cost!* All 5 handy items in this package are from the famous line of WALSCO quality products. Every radio and TV service man will want one. Get yours today!



FREE GIFT PACKAGE available at your local parts jobber. Get yours today!

WALSCO

WALTER L. SCHOTT CO.
Los Angeles 18, Calif. • Chicago 6, Ill.

New Revolutionary Aid...

Superior's TELEVISION BAR GENERATOR



THROWS AN ACTUAL BAR PATTERN ON ANY TV RECEIVER SCREEN!!

Two Simple Steps

- 1.** Connect Bar Generator to Antenna Post of any TV Receiver.
- 2.** Plug Line Cord into A.C. Outlet and Throw Switch.

RESULT: A stable never-shifting vertical or horizontal pattern projected on the screen of the TV receiver under test.

Features:

1. Provides linear pattern to adjust VERTICAL linearity, height, centering.
2. Provides linear pattern to adjust HORIZONTAL drive, width, peaking, linearity, centering.
3. Provides vertical sweep signal for adjusting and synchronizing vertical oscillator discharge and output tubes.
4. Provides vertical signal to replace vertical oscillator to check vertical amplifier operation.
5. Provides horizontal sweep signal for adjusting and synchronizing horizontal oscillator A.F.C. and output tubes.
6. Provides horizontal sweep signal to check H.V. section of fly-back and pulse operating power supplies.
7. Provides signal for testing video amplifiers.
8. Can be used when no stations are on the air.

Specifications:

Power Supply: 105-125 Volt 60 Cycles
Power Consumption: 20 Watts
Channels: 2 - 5 on panel, 7 - 13 by harmonics
Horizontal lines: 4 to 12 (Variable)
Vertical lines: 12 (Fixed)
Vertical sweep output: 60 Cycles
Horizontal sweep output: 15,750 Cycles

TV BAR GENERATOR COMES COMPLETE WITH SHIELDED LEADS AND DETAILED OPERATING INSTRUCTIONS.

ONLY

39⁹⁵ NET

Manufactured by: SUPERIOR INSTRUMENTS CO. New York 7, N. Y.

DISTRIBUTED BY THESE LEADING JOBBERS:

ALABAMA
Steel City Supply Co., Inc., 600 North Seventh St., Birmingham 4, Ala.

ARKANSAS
Country Distributors, 1201 East 2nd St., Little Rock, Ark.
Martin Wholesale Radio Supply, 1207 West Kingshighway, Paragould, Ark.
Rye Wholesale Co., 117 W. Washington Ave., North Little Rock, Ark.

CALIFORNIA
Arrowhead Radio & TV Supply Co., 1216 "D" St., San Bernardino, Calif.
C. C. Brown Company, 61 Ninth St., San Francisco 3, Calif.
California Electronics Supply, Inc., 11801-03 West Pico Blvd., West Los Angeles 64, Calif.
Cass Alshuler Co., 6038 Telegraph Ave., Oakland 9, Calif.
Dealer's Wholesale Supply, 15 E. Simpson St., Ventura, Calif.
E. M. Kemp Company, 1115 B Street, Sacramento 14, Calif.
Fred S. Dean Co., 969 American Ave., Long Beach 13, Calif.

Henry Radio, 11240 West Olympic Blvd., Los Angeles 25, Calif.
Mac's Radio Supply, 6320-22 Long Beach Blvd., South Gate, Calif.
Market Radio Supply Co., 1240 Market St., San Francisco 2, Calif.
Offenbach-Reimus Co., 372 Ellis St., San Francisco 2, Calif.
Pacific Radio Exchange Inc., 1407 Cahuenga Blvd., Hollywood 28, Calif.
Pacific Wholesale Co., 116 Ninth St., San Francisco 3, Calif.
Radio Parts Sales Co., 5220 So. Vermont Ave., Los Angeles 37, Calif.
Radio Parts Supply Co., 281 Ninth St., San Francisco 3, Calif.
Radio Specialties Co., 1951 So. Figueroa St., Los Angeles 7, Calif.
San Francisco Radio & Supply Co., 1282 Market St., San Francisco, Calif.
Scott Radio Supply, 266 Alamos Ave., Long Beach 2, Calif.
Silvergate Radio Supply, 2355 India St., San Diego 1, Calif.
Universal Radio Supply Co., 1727 So. Los Angeles St., Los Angeles 15, Calif.
Valley Electronic Supply Co., 1302 W. Magnolia Blvd., Burbank, Calif.
Jack Warren, 907 Yosemite Blvd., Modesto, Calif.

See following page for more distributors

INDISPENSABLE! PHOTOFACT BOOKS



Photofact Television Course. Covers TV principles, operation and practice. 216 pages; profusely illustrated; 8½ x 11". Order TV-1 Only \$3.00

Television Antennas. New 2nd edition. Describes all TV antenna types; tells how to select, install, solve troubles. Saves time; helps you earn more. 200 pages; illustrated. Order TAG-1 Only \$2.00

Television Tube Location Guide. Accurate diagrams show position and function of all tubes in hundreds of TV sets; helps you diagnose trouble without removing chassis. 200 pages; pocket-size. Order TGL-1 Only \$1.50

1949-1950 Record Changer Manual. Vol. 3. Covers 44 models made in 1949, including multi-speed changers and wire and tape recorders. Original data based on actual analysis of equipment. 286 pages; 8½ x 11"; paper-bound. Order CM-3 Only \$3.00

1948-1949 Changer Manual. Vol. 2. Covers 45 models made in 1948-49. Paper bound. Order CM-2 Only \$4.95

1947-1948 Changer Manual. Vol. 1. Covers 40 post-war models up to 1948. Order CM-1 Only \$4.95

Recording & Reproduction of Sound. A complete authoritative treatment of all phases of recording and amplification. 6 x 9". Order RR-1 Only \$5.00



Post-War Audio Amplifiers. Vol. 2. A complete analysis of 104 well-known audio amplifiers and 12 well-known tuners made in 1949-50. 368 pages, 8½ x 11". Order AA-2 Only \$3.95

Post-War Audio Amplifiers. Vol. 1. Covers 102 amplifiers and FM tuners made through 1948. 352 pages. Order AA-1 Only \$3.95

Auto Radio Manual. Complete service data on more than 100 post-war auto radio models. Covers over 24 mfrs. 350 pages, 8½ x 11". Order AR-1 Only \$4.95

Communications Receiver Manual. Complete analysis of 50 popular communications models. 246 pages, 8½ x 11". Order CR-1 Only \$3.00

Radio Receiver Tube Placement Guide. Accurate diagrams show where to replace each tube in 5500 radio models, covering 1938-1947 receivers. 192 pages, pocket-size. Order TP-1 Only \$1.25

Dial Cord Stringing Guide. Vol. 2. Covers receivers made from 1947 through 1949. Shows you the one right way to string a dial cord in thousands of models. Pocket-size. Order DC-2 Only \$1.00

Dial Cord Guide. Vol. 1. Covers sets produced 1938 through 1946. Order DC-1 Only \$1.00

Radio-TV Industry Red Book. 2nd Edition. Complete data on replacement parts for 22,000 sets made 1938-1950, including valuable TV information. Covers all major replacements. Over 600 pages. Order MM-1 Only \$3.95



Making Money in TV Servicing. Tested, proved methods of operating a profitable TV service business. Written by Eugene Ecklund, B. E. E., former manager of the National Service Department, Allen B. DuMont Laboratories, Inc. Covers planning, financing, work control, purchasing, service charges, advertising—plus much more. Own this practical guide to success now. Over 130 pages. Order MM-1 Only \$1.25

Order from your Parts Jobber or write direct to
HOWARD W. SAMS & CO., INC., 2201 E. 46th St., Indianapolis 5, Indiana

HOWARD W. SAMS & CO., INC.

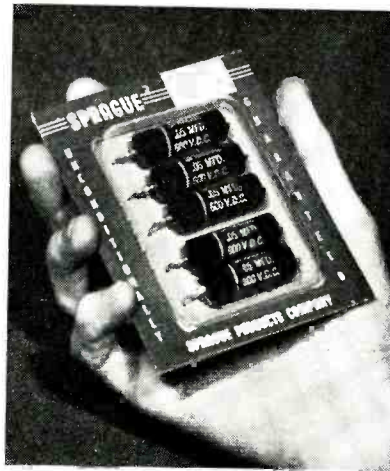

consists of a clear plastic dome mounted on a heavy cardboard backing. It is available through distributors.

Servicing Business

Allen B. DuMont Laboratories, Teleset Service Control Department, has scheduled 450 television service clinics to be held on a national scale during the coming months. The clinics will be run by DuMont regional service managers and field representatives in conjunction with the Receiver Sales Division's distributors. Meetings include lectures, a film on service and a question-and-answer period.

The Admiral Corporation has completed a series of servicing classes for independent and dealer service technicians. Factory specialists conducted the series, which was designed to train about 4,000 men.

Raytheon Manufacturing Co. announced that Main TV Supply Co., Akron, Ohio, was the latest parts distributor to be appointed as a sponsor of the Raytheon Bonded Dealer Program for the area covered by the company's Port Huron, Mich., branch.

Materials Conservation

General Electric is using an aluminum-clad material for the anodes of some of its receiving tubes to conserve scarce nickel. The company also is working on another conservation project to substitute specially processed terratec for mica spacers in these same tubes.

Dr. Burton Browne, president of the Burton Browne Advertising Agency, which handles the advertising of many companies in the electronics field, has designed a shield for inclusion in advertisements during the defense effort. The symbol which incorporates the slogan, "Conserve Critical Materials," is available without obligation to all advertisers.

New Plants & Expansions

National Union Radio Corp. purchased 50 acres of land in northeast Philadelphia as a site for a new electronics center. Construction has already begun on the first unit at a total investment of over six million dollars. It is expected to be completed around the end of 1951. Radion Corp., maker of TV antennas, has purchased a new plant in Chicago to double its production capacity. The

FOR FINE SPEAKERS
*World's Finest
Reproducer Cabinet*
by **Jensen**

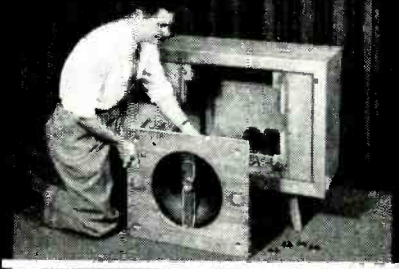
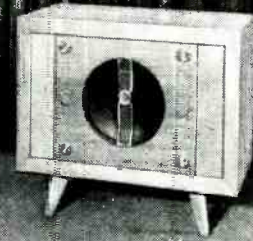

These new Customode Imperial Reproducer Cabinets combine fine acoustic performance with beautiful modern styling and new features for convenience. Speaker is easily, quickly installed or removed from the front. Adjustable Base Reflex port. Optional protective grille assembly furnished. Positive anchor nut attachment of speaker to baffle — no wood screws. Fine mahogany veneer, Blonde or Cordovan finish. Ask for data sheet 161.

Jensen
MANUFACTURING CO.
Division of The Muter Company
6601 SO. LARAMIE, CHICAGO 38

new plant adds 25,000 square feet to the company's present 23,000 square feet. Raytheon Manufacturing Co. will build a new plant in Quincy, Mass., to manufacture subminiature tubes for military use. The new plant will add 86,000 square feet to the company's factory space. Partial production is scheduled to begin in the fall of this year.

Tung-Sol Lamp Works has purchased a plant in Washington, N. J. It will add over 100,000 square feet to the company's present facilities in Newark, N. J.

Crest Television Laboratories, Inc., manufacturers of electronic test equipment, have opened new quarters in Far Rockaway, N. Y.

P. R. Mallory & Co. and Sharon Steel Corp. formed a jointly owned subsidiary, Mallory-Sharon Titanium Corp., to develop, produce, and market titanium and titanium alloys.

Sylvania Electric Products will build a new \$1,000,000 plant in Burlington, Iowa for the manufacture of radio receiving tubes. The plant, which will add 100,000 square feet of manufacturing space to the company's properties, is the third construction announced by Sylvania since the beginning of the year. W. A. Weiss, manager of Sylvania's Emporium, Pa., plant was named to head the new Burlington plant.

Jerrold Electronics Corp., manufacturer of multiple television antenna systems, has moved its production laboratory and office facilities to a new and larger plant in Philadelphia.

Workshop Associates, Inc., of Needham Heights, Mass., has become a subsidiary of The Gabriel Co. (parent company of Ward Products).

Technical Appliance Corp. completed an addition to its Sherburne, N. Y. plant which adds 65,000 square feet of factory space.

Associations

The Antenna Manufacturers Association was recently organized in New York City. M. S. Roth of Radiart was elected president, H. Harris, Channel Master, vice-president, and Ed Finkel, JFD Mfg. Co., treasurer.

The National Association of Cathode-Ray Tube Manufacturers was formed recently in New York City. Charles E. Cohn, Arcturus Electronics, was elected president; Jacob J. Samuels, Sheldon Electric Co., vice-president; Lester A. Landeau, Television Tube Research Laboratories, secretary; and Thomas A. Stave, Eureka Television & Tube Corp., treasurer.

Business Briefs

... Hytron Radio & Electronics Corp. and the Columbia Broadcasting System, Inc. jointly announced that CBS will acquire the assets and business of Hytron and its subsidiary, Air King Products, subject to the approval of stockholders. Hytron and Air King will continue operations under present management and several top officers of both companies will become directors of CBS.

—end—

**OFTEN COPIED
— NEVER EQUALED**

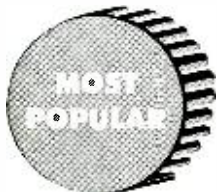
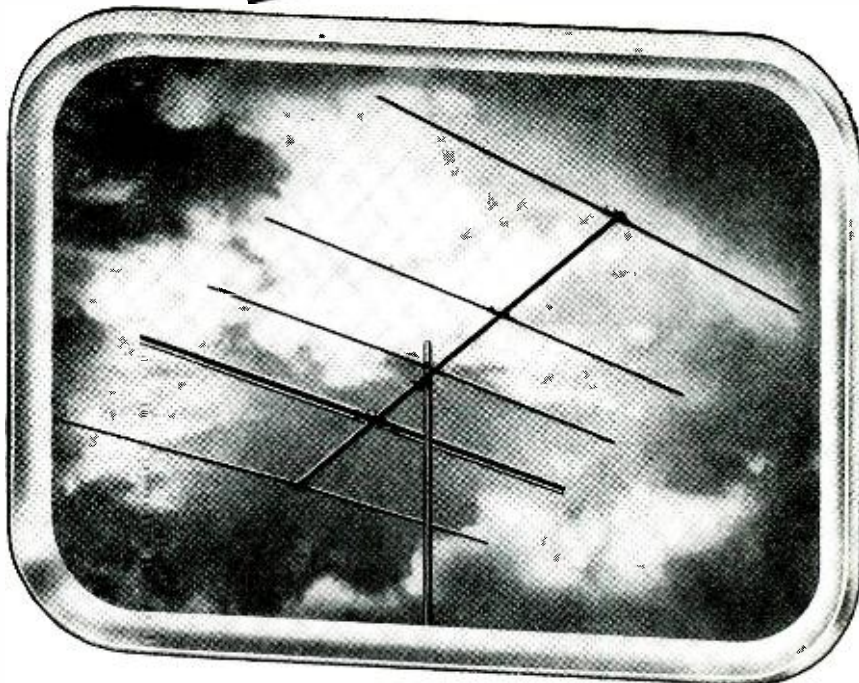

**The One and Only
VEE-D-X "JC" YAGI**

The Vee-D-X "JC" is by far the world's most popular Yagi. It outperforms and outsells all others. It is the pioneer pre-assembled Yagi — and still by far the best. Provides powerful signal at lowest cost . . . with minimum installation time. Why accept inferior copies when you can get the one and only "JC" Yagi?

**HERE IS YOUR GUIDE TO THE
WORLD'S FINEST ANTENNA SYSTEMS**

It's the big new 1951 VEE-D-X catalog — a single source for all antenna requirements. For your copy write to The LaPointe-Plascomold Corp., Windsor Locks, Connecticut.



VEE-D-X

THE WORLD'S MOST POWERFUL ANTENNAS

Now... CENTRALAB OFFERS POPULAR MAKE TV



➡ **CENTRALAB CUSTOM CONTROLS ARE MADE BY THE OLDEST NAME IN CARBON CONTROLS.** Centralab custom controls are made by Centralab, the company that introduced carbon controls to the radio industry — *25 years ago!*

➡ **CENTRALAB CUSTOM CONTROLS ARE FACTORY ASSEMBLED AND TESTED — QUICKEST FOR SERVICING.** All Centralab custom controls for TV are factory assembled and tested—including switches. They're made to exact replacement specifications and come ready to install.

➡ **CENTRALAB CUSTOM CONTROLS SAVE YOU VALUABLE TIME — HELP GUARANTEED SERVICE.** Because Centralab Custom Controls come to you ready to install — there's no time lost fumbling around with kit assemblies. What's more, you can be confident of giving guaranteed service with factory-tested controls.

➡ **CENTRALAB CUSTOM CONTROLS OBTAINABLE FROM ONE SOURCE.** You'll find these Centralab Custom Controls for TV replacement are regularly stocked by leading independent parts distributors. There's no time lost in "shopping around" for the exact replacement part.

CUSTOM CONTROLS FOR SERVICE REQUIREMENTS

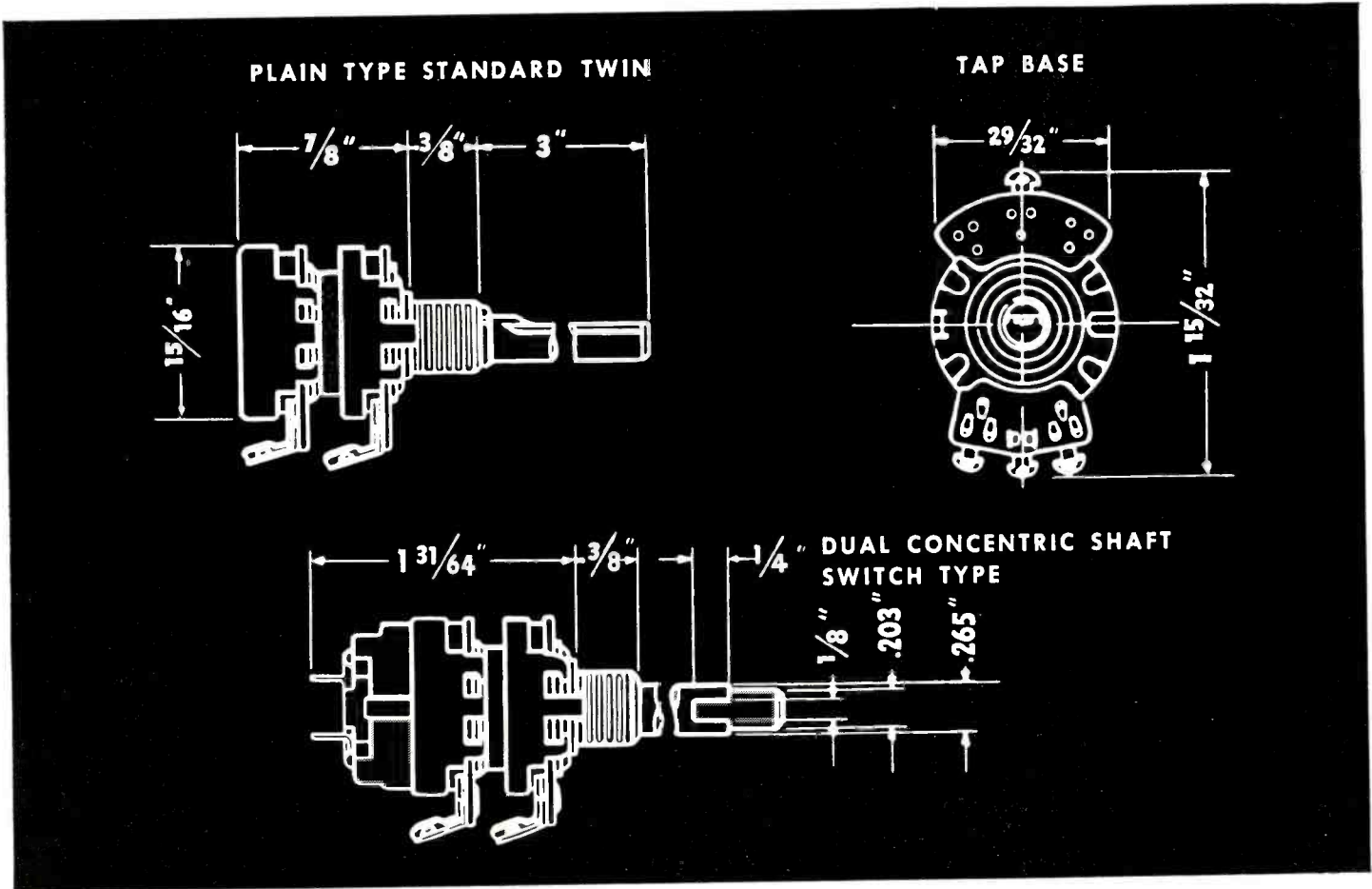

CENTRALAB HELPS YOU SOLVE TV SERVICE PROBLEMS

Along with Centralab's Custom Controls for TV replacement comes another big help to service engineers — Centralab's new TV CONTROL GUIDE. It will save you time, money and energy . . . no more "shopping around" for the exact replacement you need. The Centralab TV CONTROL GUIDE contains over 1600 listings of exact replacement

controls for nearly all popular makes and models. PLUS — AND THIS IS A BONUS FOR YOU — the industry's first replacement listing on Centralab's famous Printed Electronic Circuits! Use the coupon to get your copy of Centralab's new TV CONTROL GUIDE. It gives many dollars' worth of valuable information for only 25¢.

Centralab

Division of GLOBE-UNION INC., Milwaukee



NEW!

TV CONTROL GUIDE

WITH FIRST LISTING OF PEC'S

MAIL TODAY

CENTRALAB DIV. OF GLOBE-UNION INC.
922 East Keefe Avenue, Milwaukee 1, Wisconsin

I enclose 25¢ in stamps or coin for my copy of the new Centralab TV Control Guide which has over 1600 exact listings, plus the industry's first listing of Printed Electronic Circuits.

Name.....

Address.....

City.....Zone.....State.....

Please! I am a Service Engineer Ham Jobber TV Set-Owner

EICO
TEST EQUIPMENT

guards

Tele King
HIGH STANDARDS OF
TELEVISION PRODUCTION QUALITY



Tele-King Production Test Foreman James Adler and Harry R. Ashley, President of EICO, inspecting the use of the EICO Model 425 Oscilloscope and Model 221 Vacuum Tube Voltmeter at one of the important constant-duty alignment positions on the Tele-King television production line, New York City.

EICO KITS and INSTRUMENTS



New 555K MULTIMETER KIT \$28.95 *Wired \$45.95*



320K SIG. GEN. KIT \$19.95 *Wired \$29.95*

New 322K SIG. GEN. KIT \$23.95 *Wired \$34.95*



New 950K COND.-RES. COMP. BRIDGE KIT \$19.95 *Wired \$29.95*



New 1040K BATTERY ELIM. KIT \$25.95 *Wired \$34.95*



New 1171K RES. DECADE BOX KIT \$19.95 *Wired \$24.95*



511K VOM KIT \$14.95 *Wired \$17.95*



New 526K MULTIMETER KIT \$13.90 *Wired \$16.90*

EICO

ELECTRONIC INSTRUMENT CO., Inc.
276 NEWPORT STREET, BROOKLYN 12, NEW YORK



New 315K DELUXE SIG. GEN. KIT \$39.95 *Wired \$59.95*



New 625K TUBE TESTER KIT \$34.95 *Wired \$49.95*



360K SWEEP GEN. KIT \$34.95 *Wired \$49.95*

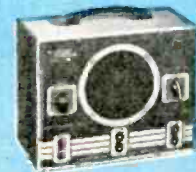

145K SIG. TRACER KIT \$19.95 *Wired \$28.95*

For Laboratory Precision at Lowest Cost—the Leaders Look to EICO!

No work in electronics is tougher on test equipment than the manufacture of quality television sets. Every week, every day, set production is pushed to ever greater volume, accelerated to ever faster pace—with no interruptions tolerated. Yet tests must be held to highest precision, costs must be kept to absolute minimum.

At the many vital testing positions along the production line of the great Tele-King Corporation—day after day, hour after hour—EICO instruments stand guard. From engineer to production chief to line tester, the men at Tele-King know that for speed, precision and utmost dependability, at maximum economy, they can always count on EICO instruments.

From coast to coast, in one famous TV factory after another, EICO instruments again and again prove their superiority. The top-flight TV set makers have discovered—just as over 70,000 servicemen have learned—that for the industry's greatest instrument values, at the industry's lowest costs—it's EICO!

Before you buy any higher-priced equipment, be sure you look at the EICO line! Each EICO product is jam-packed with unbelievable value. YOU be the judge—compare EICO at your local jobber today—and SAVE! Write NOW for free newest Catalog 6-C.

FOLLOW THE LEADERS...INSIST ON EICO!



New 221K VTVM KIT \$25.95 *Wired \$49.95*



New 425K 5" SCOPE KIT \$44.95 *Wired \$79.95*

BIO-ELECTRONICS

. . . *A vast field beckons the researcher* . . .

By HUGO GERNSBACK

BIOLOGICAL Electronics, one of the newer branches of the science, is also one of the fastest expanding ones. More and more we are coming to realize that most life processes are either linked with electronics or are electronic themselves. This is true of animal as well as of plant life.

Scientists all over the world are busy unraveling these processes, so that we may not only learn more about life and its secrets, but apply the new-found knowledge to man's progress.

Biological electronics is a fascinating science with an incredibly vast future. It pays rich dividends to all researchers who embark on its fast-moving stream. For its exploitation we require many new and refined tools; new and more sensitive electronic instruments; broader knowledge of atomic and nuclear forces as applied to biological processes. But all these will come in time to help us toward the progress for which we now grope.

Many years ago it was found that carrier pigeons lost their sense of direction when flying near broadcast stations. Evidently there is a direct relation between the sense of direction and radio waves. So far we have no conclusive answer to this puzzling phenomenon, though some encouraging results have been obtained by researchers.

The animal brain produces a pulsating electrical current. This can readily be recorded with the electroencephalograph. Tumors and brain injuries produce variations in these currents. Man's thoughts generate a different type of pulsating current. But we do not know exactly *how* these currents are produced.

The same is true of the electric eel, (*Electrophorus* [*Gymnotus*] *electricus*) and other electric fishes. From an anatomical point of view we know a great deal of the animal brain as well as of the "electrical battery" that generates the eel's current, but when we try to reproduce the eel's electric battery, we fail dismally. Nor do we know why one type of electric eel can stun and at times electrocute a horse that is standing in a river—yet the submerged eel is not even hurt by the deadly current it generates.

The researches conducted at Duke University by Professor J. B. Rhine have convinced many scientists that some people can communicate over

long distances by telepathy. It would seem that the human brain is capable of producing some type of wave motion or force capable of traversing hundreds and often thousands of miles. So far we have no instruments to intercept or record such waves or force. But the Duke scientists have been working on the problem. It is certain that they will find the answers in the years to come.

Professor H. W. Lissmann of Cambridge, England, recently investigated a "radar-guided" fish. He published his preliminary findings in the magazine *Nature*.

This incredible African fish, *Gymnarchus niloticus*, sent to him by a West African friend, swims forward and backward at will. Lissmann was puzzled as to how the fish always avoided all obstacles in the aquarium tank while swimming backward, no matter how fast its pace. This was the more mysterious since the fish has only one set of eyes—in front.

The scientist also had observed the fish's strange, finger-like tail that carries an unusual object. Lissmann concluded that this must be a radar-like biological organ—which indeed it proved to be. When two electrodes, placed in the aquarium were connected with an oscillograph, a series of regular electrical pulses registered on the oscillograph screen every time the fish swam near the electrodes.

When outside-generated electrical impulses were sent over two wires, immersed into the tank, the fish fled. He also fled in terror when a U-shaped loop of copper wire was inserted into the tank near him. When Professor Lissmann finally fed the fish's own electrical pulses back to the aquarium with a second set of electrodes, the little fish attacked them vigorously, evidently mistaking them for another fish of its own species.

At this point the fish died, either from excitement or from an overdose of misapplied electrical forces. We may hope that Professor Lissmann—with a new supply of *Gymnarchus niloticus*—may soon solve the mystery of the little fish's electronic equipment.

It is within the realm of possibility that some of our backward steering politicians could conceivably navigate the better—forward—with a biological radar!

—end—

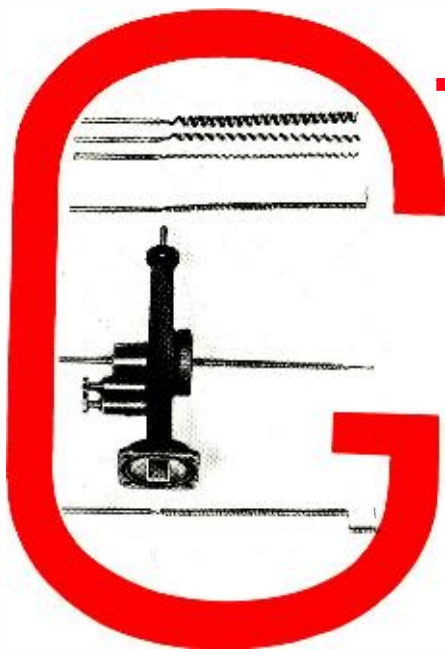

G-String Transmission

and

Helical Wave Coils

Two new techniques
replace waveguides

By

SAMUEL FREEDMAN

in u.h.f. circuits

HELICAL coils and simple straight wires can be used as a substitute for waveguides to transmit electromagnetic waves at any frequency. For microwaves, the helical coils can be unwound at their termination to serve as either nondirectional or directional radiators.

The waveguides which these two devices replace are in many cases made to special dimensions and shapes and they are expensive. Waveguides are also narrow-band devices and are rather critical with regard to frequency.

Helical wave coils like those illustrated at the head of this article have been used to replace both rigid and flexible waveguides. They first came into prominence in the development of the broad-band traveling wave tube amplifier. Depending on their termination, they are capable of covering a wide range of frequencies.

More recently, the "G-string" has attracted wide attention because it is even simpler and more economical than either waveguides or helical wave coils, and it covers a wider frequency range with much less attenuation. The G-string makes possible much longer microwave transmission lines having far less attenuation than is now possible with current waveguide techniques.

The G-string, helical wave coil, and the waveguide each have their own advantages and disadvantages, depending on how they are used, so that in many systems all three are used. Neither the helical wave coil nor the G-string have been in use long enough and in a sufficient variety of circuits so that it is possible to tell the full extent of their usefulness. They will probably become most useful at those frequencies where waveguides will be too small (super-high frequencies) or too large (ultra-high or very-high frequencies) to be practical.

The G-string

A G-string (as used in electromagnetic transmission) is simply a long cylindrical conducting wire as illustrated in Fig. 1. Its theory dates back to 1899 when A. Sommerfeld described the possibilities of using such a line for wave propagation. It was put to practical use not long ago by George Goubau and associates of the Coles Signal Laboratory of the Signal Corps.

An enamel-coated copper wire serves admirably as a G-string (No. 12 or No. 8 will do). The dielectric layer of enamel reduces the radial extension of the electromagnetic field so the waves tend to hug the wire in a large number of nonradiating modes. Special launching horns are used to excite such waves in the arrangement shown in Fig. 1. Starting from a coaxial cable, the outer conductor of the cable is flared out as a horn and the central conductor becomes the G-string.

The launching horn acts like a transformer which converts the field of the coaxial cable or waveguide to the sur-

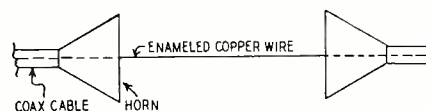

Fig. 1—Sketch of the G-string transmission line. The horns at each end keep the field pattern near the wire.

face wave field and vice versa at the termination. The larger the launching horn, the better will be the transition match. A new set of horns is needed each time the direction of the run is changed. Adding a new horn does not increase the energy at that point, but it does confine the field to the wire as it

extends into its new direction.

The most obvious advantage of the G-string is that it is exceedingly simple. While its full frequency range and attenuation characteristics are not yet fully known, the author was told that, in the study of a 120-foot and also a 600-foot length of G-string, the frequency range was from 200 to 30,000 megacycles and the transmission loss was one-tenth that of a waveguide. The author also had a report that it is possible to convey TV signals over such a line at the actual station frequency. This may mean that the underground coax or the microwave relay stations at vantage points on the horizon are no longer indispensable for network TV. The land-line may come back into its own because it is cheaper, more efficient, and is independent of FCC frequency allocations.

The helical wave coil

The helical wave coil is especially useful for microwaves because it can be used as both a transmission line and a radiator. Energy flows along both the inner and outer surfaces of the helical sheath. The field decreases to zero at the center axis of the helix, so that it can be supported by a rod at its center if necessary.

The circumference of the helix must be small compared to the wavelength if it is used as a transmission line. With the right termination, it will become a radiator. If the circumference of the helix is increased to the order of one wavelength, it becomes a radiator with maximum radiation in the direction of the helical axis, and the field is nearly circularly polarized. This is called the

axial or beam mode. Other modes also can be excited. For example, a helix with dimension not quite large enough for the axial mode will have a conical radiation pattern similar to those in dielectric rods in which the electrical

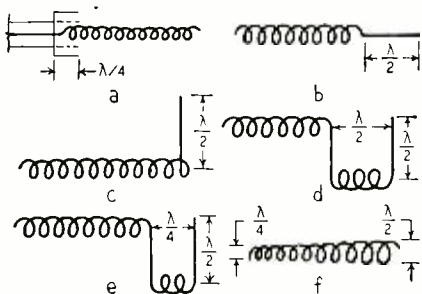

Fig. 2—Circuits using the helical wave coil to get various radiation patterns.

length of the radiator is either too long or too short compared to its physical length. For certain diameters the radiation pattern will be circularly polarized and normal to the helical axis. A linearly radiated field can be obtained by terminating the helix in straight sections. End-fire, broadside, and other multi-element arrays are easily made up by unwinding and winding helical sections.

Circuit *a* of Fig. 2 shows a section of coax terminated by a helical wave coil. The center conductor is wound into the helix and the outer conductor has an additional quarter-wave collar. The circuit is tuned by adjusting this collar to a critical length. If the end of the coil is dipped into aquadag or a graphite filler, it converts the coil to an r.f. load termination.

The circuit of Fig. 2-b may be fed in the same way as circuit *a*, but it terminates with a half-wave straight horizontal section which is a radiator. Circuit *c* is also the same, but it has a vertically polarized antenna termination. Circuit *d* is the same as *c* with a second half-wave element to produce a figure-8 pattern. A cardioid-type pat-

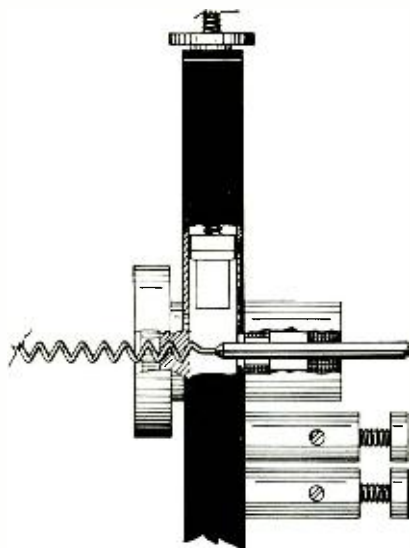

Fig. 3—Cutaway sketch showing how a waveguide connects to a helical coil.

tern is produced by *e*, which is the same as *d* except that the section between the two half-wave radiators is reduced to a quarter wavelength. The coil in *f* has a constantly increasing diameter which produces a circularly polarized pattern.

The helix can be excited by a coaxial cable by gradually winding the center conductor into a tapered helix, and at the same time terminating the outer conductor either by a flared section (similar to that used by the G-string) or by a quarter-wave coaxial choke. The latter is done by using a modified coaxial to waveguide transformer. Fig. 3 shows a typical waveguide coupler.

When used as a transmission line, the helix should be wound to have a pitch of 4 to 10 turns per wavelength, and its diameter should not be greater than 0.2 wavelength. How well the helix serves either as a transmission line or as a radiator depends entirely on how it is made. This is controlled mostly by the

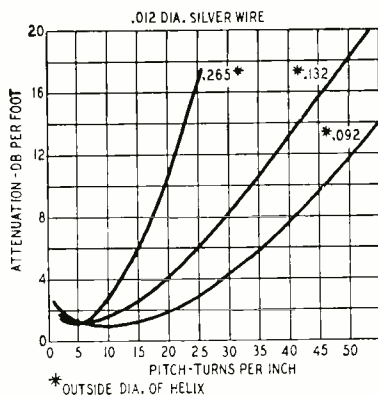

Fig. 4—Attenuation characteristics of a helical wave coil versus its pitch.

diameter of the turns in the helix, the spacing between turns, the length per turn, the total number of turns, the angle of pitch forming the turns, and the diameter of the wire which is used to wind the turns. These factors in turn determine the entire length of the helix.

Fig. 4 shows three curves which give an idea of the characteristics of the helical wave coil. They show how the attenuation losses increase as the pitch of the helix increases. Each curve is for a helix with different outer diameter, and they are calculated for a wavelength of 3.2 cm, which is a common wavelength for many radars.

By increasing the helix diameter to more than 0.2 wavelength, the coil radiates along or between its turns. Two such coils can be used as a coupling device to substitute for the rotating joints required in radar antennas. By selecting the correct diameter and pitch, the helical coil can be made to substitute for costly special waveguide configurations. Flexible helices can be used in place of flexible waveguides and waveguide elbows.

The G-string can be used only as a transmission line. It is not so adaptable as the helical coil, but it is much more efficient. Fig. 5 shows how the two can be used in combination. In this case the

G-string feeds the helical coil which is used as both a transmission line and radiator.

Both the G-string and the helical coil are easy to construct and they are especially useful where cut-and-try methods must be used to get the right circuit. Persons not too familiar with microwave techniques can use them more easily because they do not have the confusing frequency and cutoff characteristics of waveguides. The energy fields are easy to detect because they are not fully enclosed between the conducting surfaces. Further, the same setup can be used to cover a much larger part of the microwave spectrum than can waveguides.

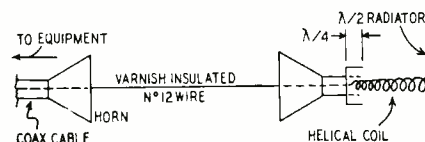

Fig. 5—A G-string transmission line used with a helical wave coil radiator.

The author wishes to acknowledge the work of Glenn Walters of Palo Alto, California, Professor John Kraus of Ohio State University, members of the Signal Corps, and others engaged in research and development of helical wave coils and G-string lines.

—end—

POLICE RADIO TRICK

With the help of handie-talkies, San Francisco police outwitted a "smart" ex-convict by trailing him for over 60 miles, not in one, but in *three* cars as he toured the city casing prospective places for stickups.

The ex-convict, Victor F. Witaschek, had kicked in a store window to get a shotgun which he planned to use for the stickups. Somebody got his license number, and police quickly got on his trail. This was their chance to test the new Motorola Handie-Talkies the department had. They operate at very high frequencies and have a range of about 30 blocks.

Witaschek drove off. Car No. 1 got on his tail, with Car No. 2 well behind and Car No. 3 running on a parallel street. Before Witaschek could get suspicious, Car No. 1 took a turn and Car No. 2 took over. Witaschek took the usual precautions. He made a sudden turn. The police car behind him kept going straight but passed the word to the car in the parallel street. For over two hours the chase went on like this—like hounds after a rabbit.

Nothing looked good to Witaschek, so he went home to try again another night. The police would have liked to nab him in the act, but rather than let him get a chance to shoot somebody with the shotgun, or to saw the barrel off the \$200 duck weapon, they picked him up when he got home. He was so astonished when they detailed his 60-mile tour that he did something a "smart" boy seldom does. He confessed.

—end—

Wired-Wireless Covers Campus

By R. H. VanHAAGEN

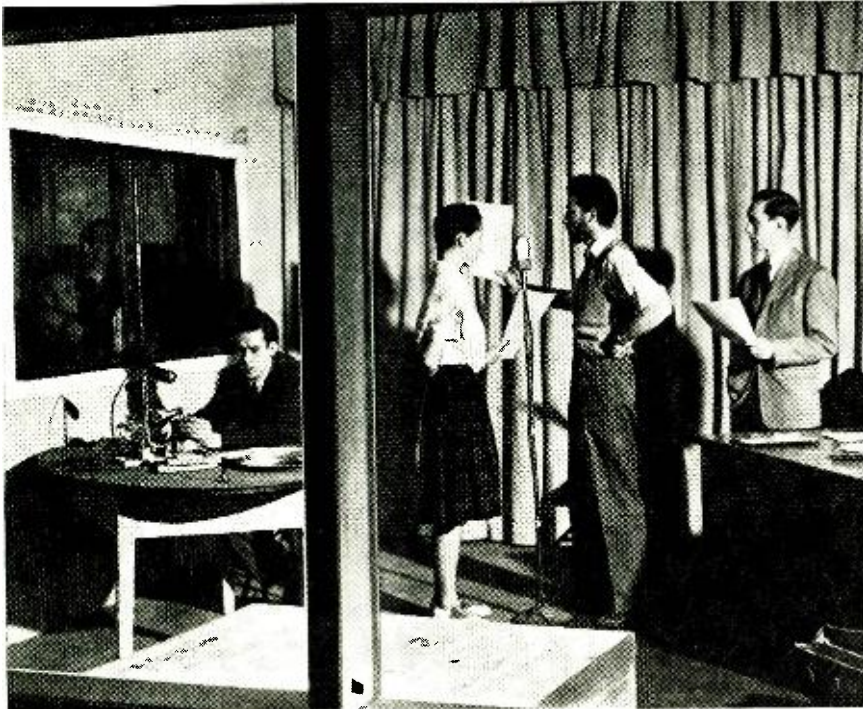

Student actors rehearse a radio show in the studios of Marietta College's campus radio station. Engineer and producer direct show from booth at left.

MANY schools, colleges, and even community housing centers have turned to a little-known phase of radio for inexpensive communication and entertainment. Although nonradiating radio-frequency carriers are well known to the electric power and telephone companies, automatic coin machine manufacturers, and other such groups, material has not been readily available to do any sort of a job in applying these principles to the fields of education and entertainment.

This was the problem which faced the Marietta (Ohio) College Radio Department when it decided to begin wired-wireless broadcasting. Careful analysis of the situation led to a successful program for student instruction in the technical aspects of engineering a broadcast, such as script writing and sound effects, and also provided experience in the electronic aspects, such as cueing of sound effects, fading of microphones and music, and placement of microphones.

Wired-wireless broadcasts have been aired daily, Tuesday through Saturday, from 6:30 to 9:00 pm. An interesting variety of programs is carried, including such campus shows as "Table-Hopping at the PX," a personal interview remote from the student center, and the very popular "Music to Study By." Daily programs are also broadcast from the local Mutual Network outlet, WMOA, over a leased telephone circuit, giving the students an opportunity to reach a greater audience than possible

by carrier-current transmission alone.

Carrier-current transmission, or wired-wireless, as it is more often called, is the transmission of a modulated radio-frequency carrier over a conductor (quite often a power circuit), so that only a specified point or area receives the signal. The wire acts as an antenna feeder, reaching to within a few inches of the receiving antenna, in the case of a power circuit. It differs from a telephone circuit in that no special line is needed, and in that the modulation must be removed from the carrying signal before it can be understood.

For home receivers, the transmitted carrier must lie within the broadcast band, where the signal may be received in the same way as any other broadcasting station. To regulate the number and types of stations on the air, the Federal Communications Commission permits no unlicensed radiation except at experimental frequencies. A well-designed carrier-current system avoids this radiation and still permits communication over a limited area. Usually the coverage is restricted to the power circuits serviced by the same transformer that supplies the transmitter.

Design points

The two main difficulties of carrier-current transmission are obtaining sufficient coverage and at the same time keeping the radiation level down to a legal maximum to avoid interfering with other services in the vicinity.

The first problem is easily solved by providing enough r.f. power to cover the desired territory or to reach the far end of the line. Now the second problem enters. The FCC regulations effectively limit the power an unlicensed carrier may use to 15 microvolts per meter at a distance (in feet) represented by 157,000 divided by the carrier frequency in kilocycles. Even within this limit, *no interference may be caused to any other service.*

As can be seen from the graph of Fig. 1, if we should use a higher frequency, transformer and other losses would be lower and the amount of power necessary to reach a given point would be less; at the same time, the radiation into space would increase at a greater rate as the frequency was increased. Thus the graph demonstrates that a lower frequency will allow us to use more power before exceeding the radiation limits. It shows purely relative values; it is impossible to calibrate the ordinates because conditions vary widely in each location.

According to agreement, all broadcast receivers are supposed to tune at least as low as 530 kilocycles. A canvass made of all radio shops in the author's community brought to light the surprising fact that nearly all home radios tune as low as 530 kc. Therefore, everyone would be able to receive a signal at 540 kc, which is below the standard broadcast band.

From this point the design of a transmitter for the radio department of Marietta College was finally started. We knew that we wanted a transmitter

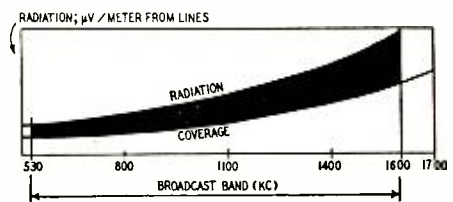

Fig. 1—Graph showing the increase in radiation and coverage with increase in frequency. These curves are relative only and were plotted experimentally.

delivering a maximum of 5 or 6 watts into our line feeders, at as low a frequency as was practical, at 100% modulation.

Planning the transmitter

The power-amplifier tube was chosen first. A beam pentode such as the 6V6-GT seemed best, and was readily available in surplus stocks. This tube requires very little grid drive, so that a buffer would not have been necessary. To maintain as much stability as possible, however, it was thought advisable to include the buffer, perhaps using a

dual-purpose tube for the oscillator and buffer, as is shown in Fig. 2. A 6SC7 high-mu duo-triode was used as a combined oscillator and untuned buffer, working into the 6V6-GT, which was modulated by paralleled 6V6-GT's. The buffer load L2 is an r.f. interstage coil with its primary removed.

The oscillator circuit in Fig. 2 is the tuned-grid plate-tickler oscillator, usually thought of as being inherently unstable. L1 is a standard broadcast band receiver oscillator coil tuned to 540 kc by a .0015- μ f fixed and a .0004- μ f variable paddler in parallel. The frequency shift during line-voltage change and mechanical shock of all L-C tuned oscillator circuits known to the author were checked with the b.f.o. of a communications receiver, and the tickler circuit showed the least shift. An OD3 regulated supply aided considerably in maintaining frequency.

The coil in the final tank circuit should be about 140 turns of No. 22 enamelled wire wound on a 1½-inch diameter polystyrene form. The secondary consists of about 10 turns wound over the center of the primary and is connected to the output terminals of the transmitter with a short length of twisted wire. C2 should be a transmitting type mica capacitor. C3 tunes the output over a small range. If the range does not cover the desired frequencies, the value of C1 can be changed accordingly.

The modulator section

The audio section in Fig. 2 does not seem exactly conventional at first glance, but there is nothing especially different about it. The dual triode serves to keep the 600-ohm audio line balanced. The output of one side is shunted to

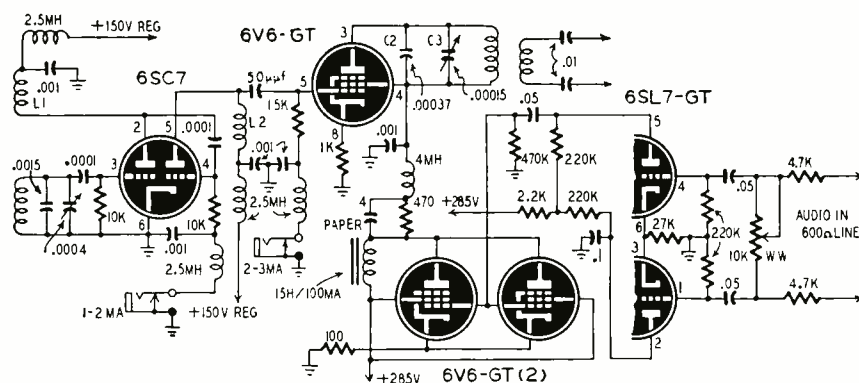

Fig. 2—The r.f. and audio circuits of the transmitter. The output is hooked directly to the a.c. line, or through a filter if harmonic radiation is strong.

ground, while the other side of it feeds into single-ended (parallel) 6V6's.¹

The 10,000-ohm potentiometer in the line is not for line balancing, but for control of the input speech level. The same output level from the monitoring amplifier as was used on the remote lines to the local network-affiliated station was correct for the input of the modulator without attenuation, so the control was set at zero attenuation and left in that position. It is mounted near the audio input socket to shorten the leads.

Transformer input would be quite permissible, but cost again enters the picture. Even if quality were to be sacrificed, the price would be several times that of a resistance-coupled stage.

Heising modulation, slightly modified, is used. An inexpensive replacement type 80-ma 15-henry filter choke is used as the plate load for the parallel 6V6-GT's, the audio voltage being applied through the 4- μ f paper capacitor (not

electrolytic), shunted by the 500-ohm resistor which provides the d.c. path.

The power supply

The power supply (Fig. 3) is conventional except for the on-off switching, which is by push-button. The four buttons, on-off primary voltage, and on-off plate voltages, are the only controls on the transmitter. Metering is by means of a vacuum-tube voltmeter from the rear.

Tube substitution is simple. Each or all of the 6V6's can be replaced with 6L6's. Except for retuning, no changes are necessary. The 6SC7 oscillator-buffer was temporarily replaced with a 6SN7-GT and a 6SL7-GT, and, although socket changes and retuning were necessary, stability and performance were only slightly reduced.

Further hints and kinks

A receiver equipped with a b.f.o. provides a simple method of determining

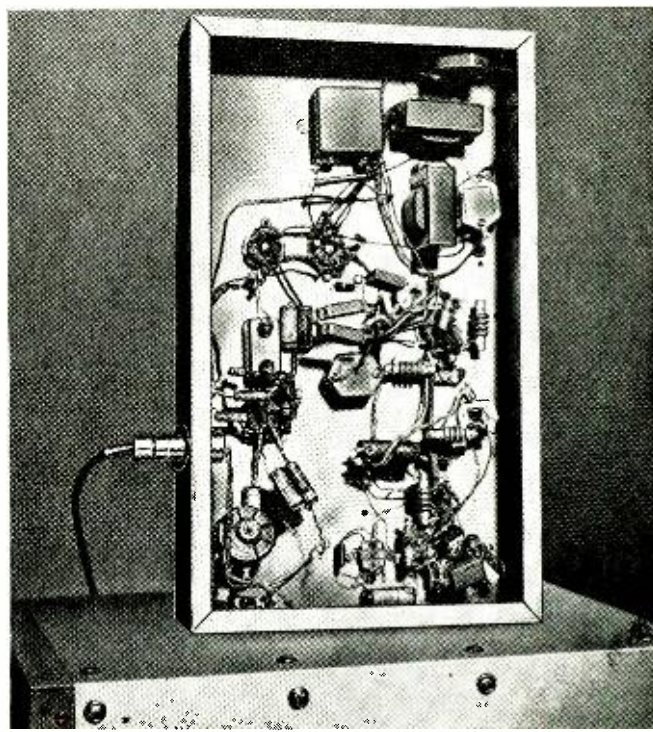
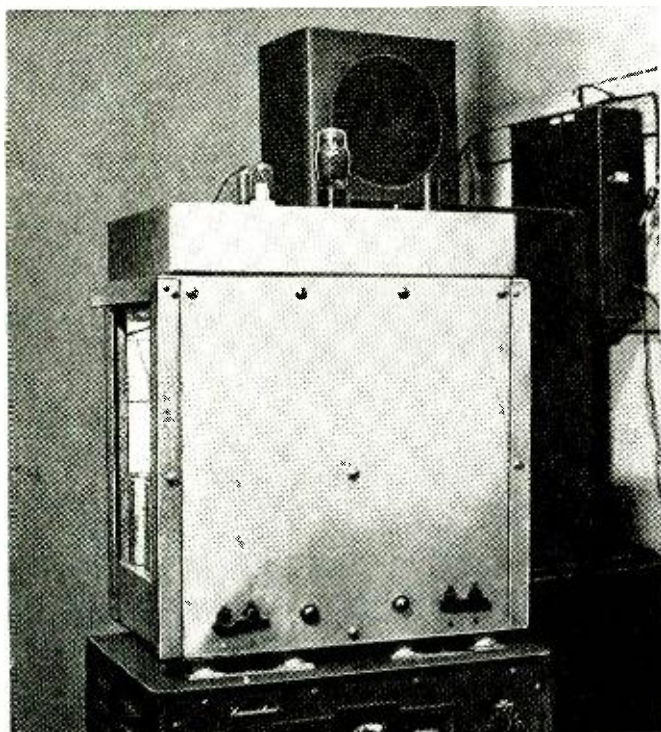

The only controls on transmitter panel are push buttons.

Bottom view of the transmitter's audio-r.f. chassis.

Television Service Clinic

Conducted By **WALTER H. BUCHSBAUM***

SHORTAGES continue to haunt the service industry and most of them will be with us for some time to come. The worst is probably the tube shortage, a large part of which is covered in this and other issues of RADIO-ELECTRONICS. Next to tubes, resistors, capacitors, and other TV parts are getting scarce.

While it is not possible to dream up replacements for every part, a great deal can be accomplished through com-

*Author of *Television Servicing*, Prentice-Hall, 1950

binning parts, modifying circuits, and similar means. For example, if you need a 1,000-ohm, 1-watt resistor, you can use two 2,000-ohm, 1/2-watt resistors in parallel instead. This is a very simple case. But suppose you need a value of resistance which you cannot obtain by substituting two equal ones? Then a

little calculation is required. $R = \frac{R_1 \times R_2}{R_1 + R_2}$

where R is the final resistance and R_1, R_2 are the two parallel resistances. In many instances resistances can be used

in series, in which case the final resistance is simply the sum of the series values.

The problem of correct wattage in unequal parallel or series arrangements may be too bothersome for many service technicians. You will get a safe value by simply using the wattage rating of the original resistor for each substitute. To calculate wattage, remember that it is the square of the current times the resistance, and that in a parallel arrangement of unequal resistors the current through each resistor depends in its resistance. Current equals the voltage divided by the resistance.

Like resistors, capacitors can be arranged in combinations to get certain values. When in parallel, their capacitances add. For example, paralleling a .05-, a .02- and a .03- μ f capacitor will give a total capacitance of .1 μ f, the sum of all three capacitors. When two equal capacitors are connected in series, their total value is one-half the value of each. Their voltage rating need be only half of the total since only half of the total voltage appears across each. When unequal capacitors are connected in series, the total capacitance is always less than that of the smallest. Their exact capacitance can be calculated from

$$C = \frac{C_1 \times C_2}{C_1 + C_2} \text{ where } C_1 \text{ and } C_2 \text{ are}$$

the series capacitors. Voltage ratings in the case of unequal series capacitors depend on their capacitance, but it will always be safe if each is rated at the total voltage across the series combination.

Coils usually cannot be replaced by combinations except in some cases in the video amplifier where peaking coil values are known. For example, if a 250-microhenry peaking coil is to be replaced, a series arrangement of a 120- and a 180-microhenry coil could be used as replacement. Inversely, to replace a 125-microhenry coil, two 250-microhenry coils in parallel could be used. Be careful to place the coils so there is little or no mutual inductance. One thing to look for in replacing peaking coils is the damping resistor which is often located inside the coil. If such damping resistors are used, a combination must be arranged so that the total of the damping resistors as well as the coils represent the proper replacement.

There are many other schemes for replacing defective parts with combinations of others. As shortages get worse, more and more "tricks of the trade" will become necessary to keep the service industry going. Your TV

WIRED WIRELESS COVERS CAMPUS (Continued from previous page)

the degree of modulation. Zero-beat the b.f.o. with the modulated signal and switch it on and off. At 100% modulation the audio level will be approximately the same for both positions. Although not a perfect check, it is usable. The chassis are standard 19-inch rack size and the cabinet was made from junk-yard aluminum. Remember, the more rigid the frame, the more stable the transmitter. Our unit was shock-mounted on rubber to further reduce shock and vibration.

The transmitter output can be fed directly to the line. If harmonics are too strong, it may be necessary to use a band-pass filter tuned to the carrier.

This transmitter would provide an inexpensive nucleus around which speech, drama, and music departments of the college could build a complete campus station, perhaps leading to the acquisition of an FM transmitter as permitted under the new educational institution regulations.

A word of warning! Many colleges using the carrier-current type of communication have received embarrassing letters from the FCC for exceeding radiation limits. Frequent and careful

field strength measurements should be made, with a good portable or car radio if a field strength meter is unavailable, especially if the conductors run above ground.

Materials for Transmitter

Resistors: 1—100; 1—470; 1—1,000; 1—2,200; 2—4,700; 2—10,000; 1—15,000; 1—27,000; 4—220,000; 1—470,000-ohm, 1/2-watt; 1—10,000-ohm potentiometer.

Capacitors: 1—50; 1—100- μ mf, mica; 1—370- μ mf, transmitting type mica; 5—.001; 2—.01; 3—.05; 1—0.1; 1—4- μ f, 400-volt paper; 1—150- μ mf variable; 1—padding for oscillator coil.

Inductors: 1—broadcast receiver oscillator coil; 1—interstage r.f. coil with primary removed; 1—output coil (see text); 4—2.5-mh, 1—4-mh, r.f. chokes; 1—15-h, 150-ma audio choke.

Miscellaneous: 1—6SC7, 1—6SL7-GT, 3—6V6-GT tubes and sockets; 2—closed-circuit jacks; chassis, hookup wire, assorted hardware.

Materials for Power Supply

Resistors: 1—100,000-ohm, 2-watt; 1—3,200-ohm, 5-watt; 1—220,000-ohm, 1/2-watt.

Capacitors: 1—16- μ f, 2—32- μ f, 450-volt electrolytic.

Inductors: 1—300-0-300-volt, 200-ma power transformer with 6.3-volt, 2-amp, and 5-volt, 3-amp windings; 1—17-volt to 16-volt transformer for relays; 1—10-, 1—15-h, 200-ma chokes.

Miscellaneous: 2—break, 2—make, push-button switches; 1—s.p.s.t., 1—d.p.s.t., 64-ohm a.c. relays; 1—2-amp fuse and holder; 1—5Z3, 1—OD3 tube and socket; 1—NE51 neon lamp; chassis, hookup wire, assorted hardware.

¹ Credit for this circuit belongs to the engineering staff of WOUN at Ohio University, from whom the idea was obtained.

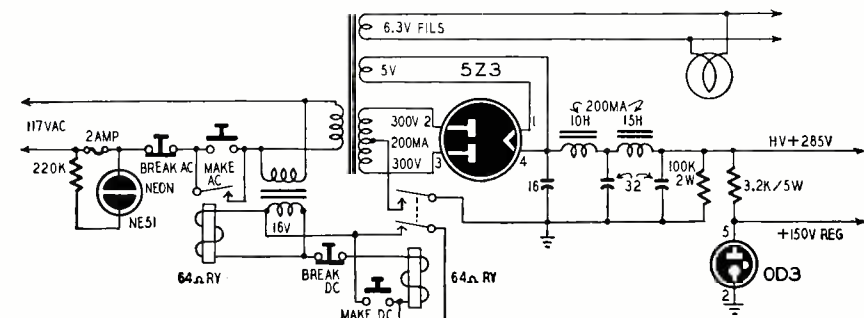

Fig. 3—The transmitter power supply. Push buttons make the circuit foolproof.

Clinic will bring you these substitutions as they come up.

When making any kind of a substitution, the service technician should be careful that the new parts are of at least the same quality as those replaced. If this is not possible, he should so inform the customer.

No brightness control

An Olympic Television model TV950 has a raster. Voltages, including the h.v., check O.K., but the brightness control has no effect, and the picture comes in with the contrast fully on.—Goldstein Radio, Brooklyn, N. Y.

Readjust the ion trap and try another ion trap, as the magnets may have weakened. Remove the rear cover of the cathode-ray tube socket and measure voltages between the green (grid) and yellow (cathode) leads. The grid should be slightly positive with the brightness control in one position and 90 volts negative at minimum brightness. Repeat these measurements with the socket off the kinescope.

If these tests do not show up the defect, you probably need a new picture tube.

Smearred image

Channel 4 comes in clear on an RCA model 6T65, channel 9 is sometimes clear, but channels 5 and 7 smear from left to right.—M. Woronka, Hammond, Ind.

Because the smear is observed only on two channels, it is probably due to the reception of these channels. Reorienting the antenna and checking the lead-in for standing waves may clear up the trouble. Take the 300-ohm line in one hand and slide the hand up and down for about 6 feet. If the picture changes during this manipulation, you may be able to improve reception. Wrap tinfoil around the antenna line at the point giving the best picture.

Intermittent narrowing

The picture on a G-E 810 receiver narrows intermittently. Several vertical bars are slightly noticeable on the raster when width is normal. This condition appeared when the horizontal output transformer was replaced.—Metz Radio Service, Hyattsville, Md.

Try replacing the damper and horizontal output tubes. An intermittent width coil or yoke connection may be at fault. Replace the 56- μ f capacitor inside the yoke, and check the horizontal drive trimmer for intermittent connections.

Rolled-up raster

After operating for about two hours, the bottom edge of the raster on an RCA 6T65 rolled up about $\frac{5}{8}$ inch to form a bright band. There it stays unchanged. We have replaced the vertical oscillator (6SN7-GT) and output (6K6-GT) tubes without result.—H. T. Bumpus, Indianapolis, Ind.

Since replacing the vertical-sweep tubes does not help, try replacing the 5U4-G. Another possibility is a faulty capacitor in the vertical section such as the cathode-bypass capacitor of the

6K6-GT, or the discharge capacitor in the plate circuit of the 6SN7-GT.

Tearing picture

The picture on an Emerson model 600 tears in the lower half, zigzagging back and forth as shown in the photo. When



the tear is severe, there is buzz in the audio. Tearing is most evident on "live" network shows. It is also difficult to get enough contrast without a distorted pic-

ture and a buzz in the audio. We contacted Emerson Radio, who told us that the trouble was severe video overload or a defective 6AL5 phase detector, or poor i.f. alignment. We have replaced the video amplifiers and the 6AL5 phase detector, and have tuned the set, but we still have the tear.—C. Hardin, Indianapolis, Ind.

From your description it appears that you get a very strong signal—so strong, in fact, that you get clipping in the last video i.f. amplifier. To overcome this, use an attenuator network in the antenna lead-in (see the TV Clinic in the March issue of RADIO-ELECTRONICS). Change the sync coupling capacitor or reduce it to a smaller value. Change the values of the video amplifier load resistor at the point of sync take-off. As a last resort, try signal-tracing the sync pulses from the second detector to the horizontal oscillator with a scope and watch for sync pulse compression.

—end—

TV DX—A Prediction of What to Expect during the month of June

The month of June is the most exciting period of the year for the TV dx enthusiast. It will also be a trying one for the technician. The conditions that make for long-distance TV reception can cause service technicians and TV station engineers no end of headaches. Our TV assignments are based on normal operating ranges, and the coverage of any v.h.f. station is likely to be anything but normal in June.

The summer sporadic-E skip¹ season, just getting under way in May, will reach its peak in the middle and latter part of June. Channel 2 reception should be possible over distances between 700 and 1,200 miles almost nightly during the month, and the higher channels, through 6, will be open only slightly less often. Though all parts of the country will see dx frequently, it will occur most often in the South and in the Middle West, the latter because of stations at the proper distances in several directions.

Sporadic-E ionization will be most dense and most widespread in two principal periods around June 12 to 14 and 24 to 27. The greater density will result in shorter skip, bringing in signals on occasion from as close as 300 miles, and simultaneous occurrence of ionization over many parts of the country will make possible multiple-hop effects, particularly during the latter period. Where there are no stations within single-hop range (normally 700 to 1,200 miles) to blanket them, signals from as far as 2,500 miles away may be observed.

The most likely time to try for dx via sporadic-E skip will be around noon or shortly before, and from 5 to 10 pm

local time, though it may be observed at any hour that stations are on the air. Low spots of the day will be mid-afternoon and the hours after midnight.

Tropospheric bending¹ will also be frequent and pronounced during June, though this is not the peak month for this type of propagation. Satisfactory reception range of low-band stations will be extended to as much as twice normal coverage when weather conditions are right, and high-band stations will be seen at distances of several hundred miles on a few occasions.

Best times for tropospheric dx will be the hours around sundown, and after 10 pm. All parts of the country will have tropospheric dx reception, but locations along the Atlantic Seaboard, the Gulf Coast, the West Coast, the Great Lakes areas, and the Lower Mississippi Valley will be especially favored.

Dates for best tropospheric bending are not readily predicted in advance by more than a few days, but a look at the daily weather map in your local newspaper will give you some good clues. A large stable high-pressure area coming over your part of the country will be one of the best warnings that some time spent in trying all channels may be rewarding.

To catch the best of the dx, you will have to do a lot of watching, because no amount of forecasting and weather-map watching will tell you exactly how the signals will hop around. Good dx'ing depends to no small extent on patience, persistence, and a lot of sheer good luck.

¹ "What's the Mystery Behind TV DX?" RADIO-ELECTRONICS, May, 1951.

—end—

HOME BUILT BOOSTER INCREASES TV RANGE

This a. c. powered circuit
produces amazing results

By "DOC" GAINES

OUT where the West really begins, some 235 air miles from Omaha, lies a place that I call home. Great was the amusement in this small community when it became known that I had foolishly purchased a television receiver. However, since that day I have had the last laugh many times, all due to my homemade signal booster. Not only did my booster bring television reception to this area, but it is adding greatly to the pleasure of TV reception in metropolitan Omaha and Lincoln.

The nearest TV stations are KMTV, channel 3, and WOW-TV, channel 6, both in Omaha. The useful audio and video signal input to my receiver was practically zero, indicating the need for a substantial boost in signal strength. For all-around performance, a tuned-grid, tuned-plate circuit using a 6J6 or similar tube seemed best. Such a booster, when used with a well-filtered a.c. power supply, will astound even the most skeptical.

Reception with this booster far surpassed the best results obtained with any commercial boosters. For the fringe-area viewer this booster supplies a signal of usable value and for the metropolitan owner in a weak-signal location its tendency to reduce ignition interference, in both audio and video, makes it a must in all but the best television areas.

The circuit

The power supply and booster can be built on the same chassis with no loss in efficiency. I constructed my boosters on two separate chassis measuring 3 inches wide, 5 inches long, and 2 inches deep. One is for channel 3 and the other for channel 6. Since the physical size of transformers and chokes vary great-

ly, the size of the power-supply chassis depends on the parts you use.

The power transformer must deliver 240 volts d.c. under load. The dropping resistor R1 is optional and is of such a value as to deliver 150 volts d.c. to the plate pins of the tube socket under load.

In my first experiments I used slug-tuned coils from a surplus Army tank transmitter. However, these forms are difficult to obtain, and I find that Mil-len 69045 forms are even better. These forms have a winding length of $1\frac{1}{16}$ inch and a winding diameter of $\frac{1}{2}$ inch. The iron slug is $\frac{3}{8}$ inch in diameter by $\frac{1}{2}$ inch in length. All coil data in this article refers to the Mil-len 69045, but any equivalent form may be used. In using forms other than the Mil-len 69045 make certain the form is long enough so that when the slug is turned completely out no part of it engages the coil windings. Coil windings L2 and L3 are space-wound for the desired channel. The winding is then insulated by a single layer of masking or Scotch tape before applying windings L1 and L4. See the table for coil data. If No. 19 wire is not available No. 18 or 20 may be used. Make certain that L1 is reverse-wound in regard to L2. The same applies to L3 and L4.

Adjustments

Very little capacitance need be added to prevent oscillation in this circuit. The neutralizing condensers C1 and C2 are constructed of $\frac{1}{8}$ -inch diameter copper tubing $\frac{3}{4}$ inch long with one end soldered to each grid pin at the tube socket. To each plate pin solder a piece of No. 22 well-insulated copper wire. Cross the wires from plate to opposite grid and insert them $\frac{1}{2}$ inch into the tubing to complete the neutralizers. Positive in-

sulation inside the tubing can be obtained by sliding spaghetti over each wire.

To neutralize this circuit, hook a signal generator to the input coil and a v.t.v.m. to the output coil. With the filament voltage removed and the generator supplying a signal of a frequency corresponding to the booster channel to be tuned, vary the distance that each wire extends into the tubing until minimum output is recorded. The null is very definite, although the tuning range is very broad.

By substituting 1.2-megohm resistors for the 120,000-ohm grid resistors R2 and R3 a total gain of 35.2 db is obtained. This is recommended only for extreme fringe areas, as the noise ratio increase exceeds that of the signal. The 23.8 db gain using 120,000-ohm resistors for R2 and R3 will give satisfactory reception up to a distance of 125 miles or more. This value of grid resistance furnishes the best signal-to-noise ratio.

Our next step is adjusting the coils. This is done with the same equipment hookup we used in neutralizing the booster. With the filaments on, we adjust the input coil L1 for maximum output at the video frequency and the output coil L2 for maximum output at the audio frequency. The final adjustments or fine tuning is made with the booster under actual operating conditions.

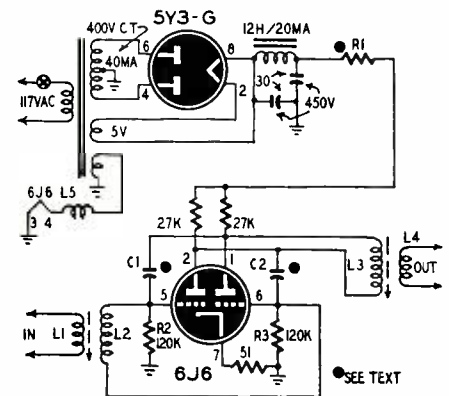

The circuit of the booster. A separate unit for each channel is recommended.

A separate booster for each channel is recommended, as it is slow work to adjust the slugs properly when changing channels. This is particularly true in fringe areas where any mismatch means a loss in gain.

Any type of switching arrangement that completely disconnects from the circuit when not in use will be found to be satisfactory.

Be sure that the switching arrangement includes provision for removing all plate voltage from the booster not in use. Failure to do so will cause the final adjustments to vary and make true alignment impossible. This is due to a field set up by the unloaded booster. No plate voltage means no field to cause trouble when making final adjustments.

—end—

TV Relay With PCM

By I. QUEEN

PCM or pulse code modulation may be the answer to long-distance relaying of TV programs. With PCM a signal may be relayed any number of times without adding appreciable noise or distortion.

In PCM the TV wave is sampled at twice its maximum signal frequency. For a TV bandwidth of 5 mc, this is 10 million times a second. At each sampling, the wave amplitude is noted. For example, the voltage of a wave may vary at successive intervals of .000001 second as follows: 17, 18, 19, 19, 17, 15, 13, 12, 13 . . . If this information is transmitted as fast as it is determined, receiver circuits may be designed to re-create the wave.

A varying wave may have an infinite number of possible amplitude levels. However, the wave may be approximated quite closely if it is assumed that only certain standard levels may exist. Experience shows that with 32 standard steps or levels, good picture detail can be obtained. Therefore maximum amplitude is taken as 31 units. Any other amplitude is quantized to the nearest whole number. For example, a level of 12.4 units is taken as 12, while 12.6 becomes 13. This shows that the quantizing process does introduce a slight error (maximum of $\frac{1}{2}$ unit). The error is small, but it could be reduced by using even more units.

The PCM system uses pulses of equal amplitude and width. Any number (from 0 to 31) is represented by a 5-digit code group. A digit is a predetermined position (in its group) which may or may not be occupied by a pulse. The weightings of the pulses are, in their digit order: 16, 8, 4, 2, 1. Thus, if only the first, third, and fourth pulses occupy their assigned positions (and the other two are missing) the group indicates 22 units.

Noise is reduced because pulses can exist only at predetermined instants. The receiver can easily eliminate noise and interference which might arrive between pulses. Pulses occupy only a small fraction of the total time. Furthermore, each pulse has the same amplitude, so there is no problem if noise modulates them.

When a 5-digit code is transmitted through a single channel, a bandwidth of 50—100 mc is required. This can be handled by a microwave relay system. If the digits are transmitted along separate channels, the bandwidth is reduced proportionally and wire circuits may be used.

At present PCM for TV is in the experimental stage.¹ However, it promises to be an important factor in TV relaying in the future.

¹ Bell System Technical Journal, Jan. 1951.

SMELLEVISION NOW HERE!

Inventors have sought at different times and in various ways to add the illusion of scent to the arts of the theater. Scents actually have been released among the audience in experimentally produced plays, with some success, but apparently never enough to make scent effects a regular part of the theater. Patents have even been taken out for scent devices for use with motion pictures.

It remained to New York inventor Emery I. Stern to add scent effects to television. The idea no doubt was suggested by friends' remarks about some of the current programs. The theory of his invention is simple. As shown in Fig. 1, an oscillator supplies a lamp with current modulated at a frequency controlled by the switches connected to the oscillator. The lamp throws a beam on a corner of the iconoscope, making a modulated pattern there which is presented in the same corner of the receiving kinescope. It is a comparatively simple matter to detect the signal with a photocell (Fig. 2) and use each frequency to trip its own relay, releasing the appropriate odor into the blower system, which appears quite adequate to spread the smell through the average living room. The scents of course are kept under pressure so that as soon as each valve is opened by its relay the odor will gush out into the blower tube.

More elaborate methods for diffusing the scents would be used in auditoriums. The heating or cooling system of the auditorium might be used to cause air currents of the correct temperature and speed. The appropriate scent mixture would then be added to the air as it enters the room. It would also be very important that the scent be mixed with

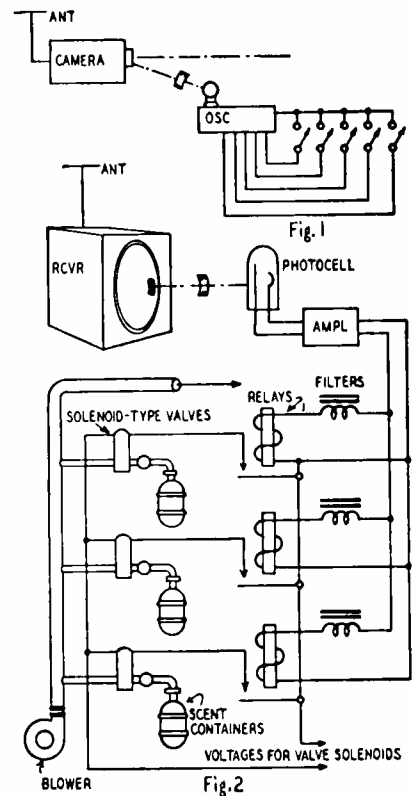

the air in the proper proportions, so that it is strong enough for all in the auditorium to smell it, yet not too strong to spoil the desired effect.

How many of the containers will be necessary and what scents are considered the most useful on a television program are matters not mentioned in the patent, which is No. 2,540,144.

—end—

Orientation Wrinkles

The problem of orienting a TV antenna can be as full of surprises as a grab bag at a church bazaar, if the experience of Warren Werneke, of St. Paul, means anything.

He is a video enthusiast who lives in the Twin Cities area of Minnesota, where two TV stations serve the many listeners in St. Paul, Minneapolis and the surrounding territory. The stations are in the same general direction from his home but at a wide angle of separation.

His apartment building is cut off from line-of-sight to these stations by a towering hundred-foot bluff directly to the rear of his home.

The antenna had been carefully oriented but he wasn't sure that the picture was all it should be. And being a dyed-in-the-wool electronics hobbyist he decided to do something about it. He picked a likely looking spot near the chimney and visualized a field of stand-

ing waves just waiting to be picked up.

Tuning to the weaker of the two stations, he adjusted the set, assigned his wife to watch the screen, and told her to call him the instant there was an improvement in the picture. Then, with a fellow enthusiast, he climbed to the roof.

They loosened the guy wires and brackets and lifted the array out of its moorings. They carried it as far as the transmission line would reach, turning it in all directions. No improvement anywhere! Finally, tired and disappointed at the failure to locate a better signal area, they put the antenna flat on the roof, in disgust.

Right then they heard the enthusiastic voice of their TV observer. With all the enthusiasm she could muster she was shouting, "You've got it . . . leave it there . . . don't move it . . . it's a picture right out of this world . . . a perfect picture!"—James H. Bell

TV TROUBLE LEXICON

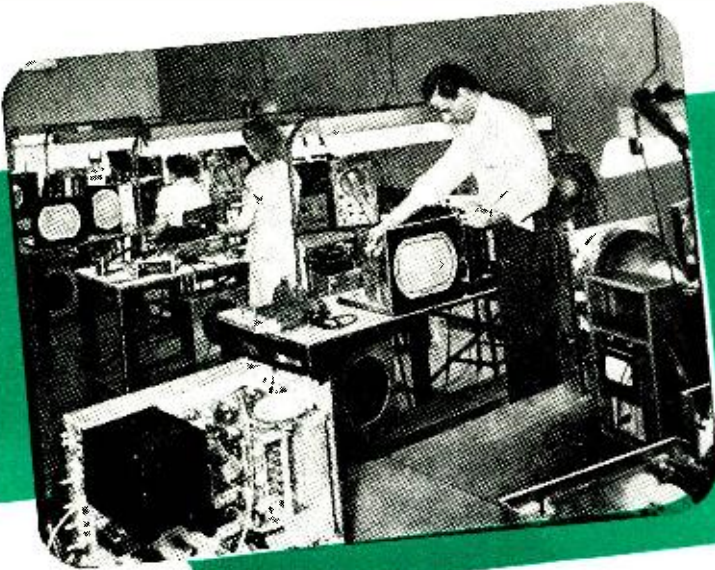

Continuing the quick-reference TV technote list of common faults

By

JOHN B. LEDBETTER*

Last month the operating peculiarities or typical symptoms of trouble in television receivers beginning with Admiral and continuing through Du Mont were covered. In this issue, we resume with Du Mont and include as many makes of receivers as space permits.

Du Mont

RA-103D. Collapsing of picture vertically (earlier models only). Arc between crossed plate and grid leads under socket of vertical deflection amplifier. Remedy: route one lead inside the socket and other lead outside.

Noise in audio. Arcing in base of 6SN7-GT vertical deflection amplifier (certain makes only). Du Mont would appreciate information on make of tube when this condition is encountered.

RA-104A, 110A. One or more black vertical lines on left side of raster. (Caused by Barkhausen oscillation). Improper adjustment of horizontal drive control. Defective 6BG6-G. Improper antenna lead-in (use coax line only). Transmission-line pickup from power supply. *Note:* Route lead-in as far away from power supply chassis as possible; ground power supply and main chassis together by anchoring to a common copper plate.

RA-105. A.g.c. drift (change of sensitivity as set is operating). Defective 6AT6 a.g.c. amplifier. When this tube is replaced, always readjust the a.g.c. setting.

Low Sensitivity (new set). Check a.g.c.

adjustment. This may have been jarred accidentally during shipment.

RA-105, -106. Loss of vertical sync (humid climates). Open primary in vertical blocking oscillator transformer. Impregnated units are available from manufacturer for use in high-humidity areas.

RA-105B, -108A. Filaments of 5U4-G rectifiers will not light. If 5U4-G's are good, check the .05- μ f cathode capacitor. If this shorts, the regulated voltage of the 5U4-G's will drop very low and give the appearance of no filament voltage. Also check capacitor C302 for possible short, or the wiring going to it for short or arc to chassis.

RA-105B, -108A. Hook (top portion of picture leans to left). Change .01- μ f capacitor C263 (in grid circuit of sync clipper V217) to .05 μ f or 0.1 μ f (0.1 μ f is preferable if heavy ignition noise is not encountered). Later models are modified to allow selection of .01 μ f or 0.1 μ f value as desired.

RA-105B, -108A. Vertical jitter (compression of sync in narrow-band sync amplifier). Where sync compression is cause of jitter, change the 6AU6 narrow-band sync amplifier (V225) to a 6BA6 and change resistor R363 from 22,000 to 15,000 ohms. Remove 100-ohm resistor R356 (connected from pin 7 to ground) and install a 68-ohm resistor in series with a 220-ohm resistor from pin 7 to ground. Bypass the 220-ohm resistor with a .01- μ f capacitor and realign narrow-band amplifier.

For increased gain, replace all 6AG5's with 6BC5's. (A 6BC5 has a higher gain than a 6AG5.)

Microphonic condition. Defective 6AB4 oscillator. Replace tube, or try reversing speaker leads.

Broken top slug in horizontal oscillator transformers. Replacing entire transformer is not necessary. Replacement slugs are available from manufacturer's spare parts department. Usually the top slug is broken and can be replaced simply by removing shield can and extracting slug. Broken bottom slug requires disconnection of transformer leads.

RA-108A. Thumping (with 19AP4 metal picture tube). Warning tag on h.v. lead striking side of tube. Re-position tag.

Hum in audio. Heater-cathode short in 6AL7-GT tuning indicator.

RA-109A, -111A. Low sensitivity on high channels (low oscillator injection voltage). Remedy: Remove Inputuner and dress 1- μ f capacitor C115 as far as possible from bottom of Inputuner chassis. Place close to standoff insulator between 6AK5 convertor and 6AB4 oscillator. Do not disturb the position of other Inputuner components.

Weak picture (very snowy); weak sound. Defective 6SN7-GT a.g.c. clamp. If this tube is in a nonconducting condition, the effect may not be apparent immediately but may cause the 6J6 r.f. or 6AK5 mixer to become defective.

Horizontal wavering (top third of picture). Check with TV station. They may be operating with their sync generator on short a.f.c. sync time constant instead of long time constant.

No high voltage. Defective 1X2 h.v. rectifier. Defective 6AK6 horizontal oscillator or 6SN7-GT horizontal saw-

* Engineer, WKRC-TV

maker. Blown ¼-amp fuse in damper plate circuit.

Replacement fuse blows. Check deflection yoke.

Insufficient picture size (horizontal and vertical). Focus control at extreme of range. Defective 5U4-G low-voltage rectifier.

Overloading with normal contrast (near station). Insufficient a.g.c.; signal is overdriving receiver. Check setting of a.g.c. control.

Tearing out (top of picture). Insufficient a.g.c. Check control setting.

Attenuation of weak stations. Excessive a.g.c. Reduce.

RA-111A. Beat interference (black horizontal streaks) on channel 7. Eighth harmonic (175.2 mc.) of sound i.f. (21.9 mc.) beating against video carrier (175.25 mc.) of channel 7 to produce a 50-kc beat. Remedy: Remove filament connection between 6T8 first sound amplifier and 6AQ5 second sound amplifier. Reconnect filament of 6AQ5 to filament tie-point of Inductuner (located near chassis front end, between band switch and contrast control). Connect a 5,000- μ f capacitor between 6T8 filament (pin 4) and ground. Note: Beat can also be eliminated by shifting i.f. from 21.9 to 21.75 mc.

Bright flashes on screen when tuning (most evident on high channels). Noisy Inputuner. Remedy: Lubricate with Lubriplate No. 105 (available from distributor of manufacturer). Apply only to contact rings of Inputuner.

Emerson

600, 639. Insufficient picture size. Defect in low-voltage supply (check for open or decreased value in filter capaci-

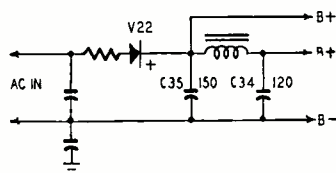

Fig. 1—An Emerson low-voltage circuit. tors C34 (120 μ f) and C35 (150 μ f). (See Fig. 1.)

609. Loss of brilliance (areas of severe dust accumulation). Dirt in projector unit. To clean mirrors, remove one side panel of projection unit. Do not wipe dust; remove with camel's-hair brush and polish with soft lens tissue. Use cleaning spray if discoloration is excessive. Clean top of corrector lens with soft lint-free cloth or tissue. Do not use alcohol or other solvents which might damage or loosen the lens cement.

No high voltage. Defective 6SR7 high-voltage oscillator. Defective 6BG6-G. Shorted h.v. capacitors (5,000- μ f or 2,500- μ f. Defective EY51 high-voltage rectifiers. (The h.v. power transformer,

filter capacitors and EY51 tubes are in a sealed can. A defective unit requires replacement of the entire can).

621, 622, 628, 630. TV operative, FM inoperative. Defective 12AU7 heterodyne oscillator. Defective band-switch contacts, leads, or soldered connections.

Fada

799. Horizontal jitter. Defective 6K6 horizontal oscillator or 6AC7 horizontal sync reactance tube. If replacing either of these tubes results only in temporary correction of trouble, look for leaky .005- μ f capacitor across synchrolock transformer.

Farnsworth

GV-260. Horizontal nonlinearity. Shorted turns in horizontal deflection coils. Shorted .008- μ f capacitor C58, 300- μ h coil L30, or 1,500-ohm resistor

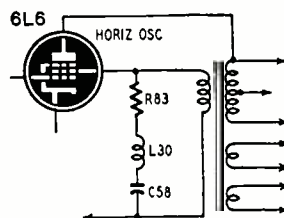

Fig. 2—A faulty part in the horizontal sweep oscillator may cause nonlinearity.

R83 in beam relaxor (6L6 horizontal oscillator) grid circuit. See Fig. 2.

Picture size changes or jumps when vertical centering control is moved. Defective vertical centering capacitor C105.

Picture jumps or moves only to one side when horizontal centering control is moved. Defective horizontal centering capacitor C107B or C107C.

Stationary bar in picture. Hum pickup in video chain. Defective filter capacitor in power supply.

Different shading in top and bottom portions of picture. Poor low-frequency response in video amplifiers. Open or partially open 10- μ f filter capacitors C102A or C102B, open 10- μ f cathode bypass, or open 0.1- μ f coupling capacitor (6AC7 video amplifier). Open .01- μ f cathode bypass capacitor (6SN7-GT d.c. restorer).

Garod

10TZ, 12TZ (Tele-Zoom). Failure of tele-zoom feature. Open connection or defective lead in 20-foot remote-control cord. Dirty switch or relay in receiver.

12TZ20. Intermittent distortion, drift in sound (high channels only). Defective 12AT7 oscillator.

1042G, 1043G series. Picture blooming (when brightness is increased). Increase in value of 470,000-ohm series anode resistor R88. (This applies to all receivers with series resistor in picture-tube anode lead.)

Parasitic oscillations in horizontal sweep oscillator. Change 5,600-ohm suppressor resistor R75 (plate of 6SN7-GT horizontal oscillator) to 4,700 ohms.

General Electric

12T3, 12T4. Audio buzz (on weak signals or with set adjusted for best picture on low contrast). Caused by 41.25-mc trap in second video i.f. Try shunting trap and tuning capacitor C281 with a 5,100-ohm resistor. (Later models eliminated trap entirely.)

800, 805, similar models. Sound bars in picture. Open or decreased capacitance in 5,000-mf capacitor between one end of focus coil and B-minus.

Audio Buzz. Open or decreased capacitance in capacitor C278 (connected between B1-minus and B2-minus).

Alternate light and dark bars, accompanied by foldover. Open 150- μ f filter capacitor C373, causing reduction of B-plus voltage to horizontal output and damper tubes.

White vertical bar in center of screen, wide black vertical bar on either side. Open in horizontal deflection coils (plate side of damper tube).

Raster normal for several seconds, narrows to vertical line, then blanks out. Open 6BG6-G grid resistor.

810. Horizontal stretching of left side of picture, slight foldover. Change in value of 0.1- μ f capacitor C55 in damping-tube cathode circuit.

Light vertical lines. Change in value of 47- μ f capacitor C56 in series with damping tube plate and horizontal deflection coils. Deflection yoke defective (check by substitution).

817, 821. Insufficient width, accompanied by black horizontal bars and decrease in brightness. Shorted 0.47- μ f bypass capacitor C324 in series with horizontal deflection coils. (C324 is paralleled with a 1,200-ohm resistor.)

Faint white vertical line in center of picture. Incorrect adjustment of horizontal linearity control. (This can also cause interference to broadcast sets.)

817, 825. Excessive brightness on left side of screen, suggesting form of foldover. (Left side stretched, faint white lines across rest of picture.) Defective 5V4-G damper.

835, similar models. Sound modulation of oscillator tube. Caused by feedback or mechanical vibration from speaker. Remedy: Shock-mount speaker on rubber grommets or spacers.

The foregoing notes were compiled from the service manuals and service bulletins graciously supplied by the various manufacturers named, and from field notes of the author.

(continued next month)

L-C COMPARATOR AIDS INDUSTRY

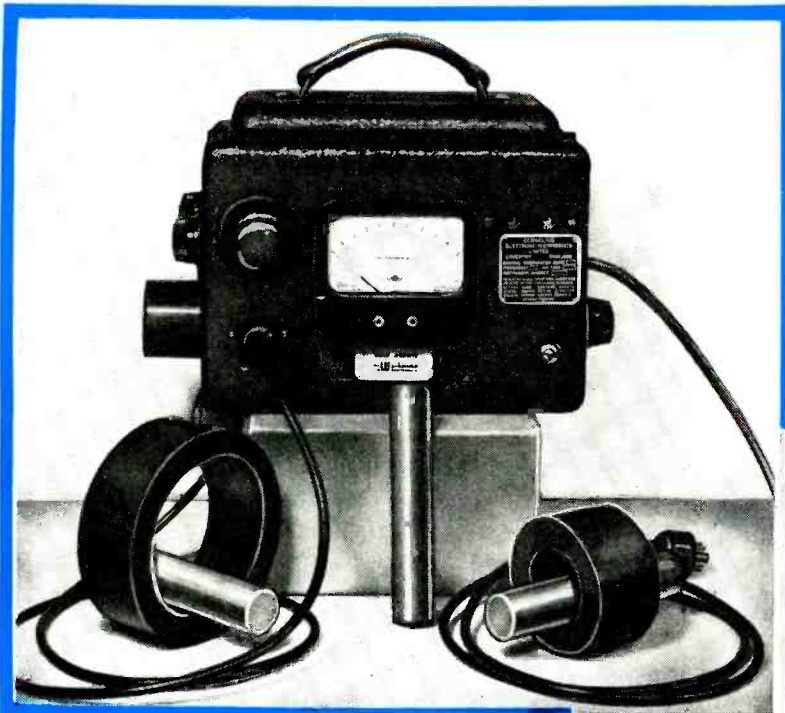

Photo A—The inductance comparator. A sample that is not passable produces a new reading.

PRACTICALLY all industrial measurements made with electronic equipment depend on the measurement of resistance, inductance, or capacitance. Resistance instruments are legion, but they have the great defect that they indicate movement in the subject being tested, and this movement must be transferred to some other device such as a strain gauge. These measurements can be very accurate, but the problem is that stress measurements cannot be made with strain gauges.

This leaves capacitance and inductance. In general, any movement of the subject to be tested can be detected by capacitance measurements, while variations in composition either as alloys or as defects can be found with inductance measurements. Variations in composition of many nonmetallic materials can be detected with the capacitance method, while in some cases variations in dimensions of nonmetallic materials can be detected by a combination of both methods.

The obvious conclusion is that only three instruments are needed for almost all industrial applications: one purely inductive, one purely capacitive, and one combined unit. These three instruments are shown in the accompanying photographs and diagrams. They are a product of Cornelius Elec-

*Cornelius Electronic Instruments, Ltd., Coventry, England

Stress and strain tests using electronic techniques

By

JAMES R. CORNELIUS*



Photo B—The combined inductance-capacitance instrument in a setup to show the stress-strain relation of a steel sample.

tronic Instruments, Ltd., of Coventry, England. They have been used for innumerable different tests from detecting strata variations in oil well borings to measuring the impact of an electron in a cloud chamber.

The inductance comparator

The instrument shown in Photo A and Fig. 1 is the inductance unit. It can be used as a low-frequency, high-frequency, or mixed-frequency unit, and the frequency is changed merely by changing a plug-in coil on the left side of the unit.

When operating at low frequencies, the unit requires a detector coil of suitable size (two such coils are shown in Photo A) to fit the work being tested. It need not match exactly the

dimensions of the work to be tested as long as the work will go into the detector coil easily. This coil plugs into the front of the unit.

Each detector coil has a matching oscillator coil plugged into the side of the instrument. The side coil connects the cathode of the 6J7 to ground, while the detector coil connects the grid of this tube to the cathode to form a very loosely coupled Hartley oscillator. The coupling is adjusted so the 6J7 just barely oscillates. The stronger the oscillation, the less sensitive the instrument becomes.

The detector coil is coupled to the grid of the oscillator tube through one of five capacitors selected by S2. This capacitor has some effect on the strength of oscillation but it also con-

trols the harmonic content of the voltage induced in the test specimens.

The two coils are also coupled to each other through a large variable capacitor C1 in parallel with one of five others selected by switch S1. This gives a capacitance range sufficient to cover practically any frequency required between 500 and 25,000 c.p.s., which is the low frequency range of the instrument.

To use the instrument as a comparator, a known specimen of the material to be tested is inserted in the detector coil and the instrument is adjusted to an approximate frequency suitable for the work.

For either surface tests or for deep penetration tests, S1 being set to minimum capacitance and the potentiometer R1 for minimum screen voltage, the unit is not oscillating. R1 is then turned up until the unit just begins to oscillate as indicated by a deflection of the meter. C1 is then adjusted so the meter reads at about +4 (the meter is a zero-center instrument with five divisions either side of zero).

When another sample of the test material with somewhat different characteristics is inserted in the coil, the meter needle will fall either completely to the left or to the right. If the test specimen is very similar to the known specimen, the meter needle will float because the oscillator will hunt.

As an example, with a 2-inch coil for steel screws 10 mm in diameter and having a carbon content that is allowed to vary by only 0.2%, an operator can select the good from the bad at an average speed of 4,000 per hour without fatigue. After about ten days' training, an unskilled operator can use the instrument to select brasses, aluminum alloys, coppers, plated goods, etc. without supervision by skilled craftsmen.

To operate on high frequencies (25 to 100 kc), the side coil is removed and a single combined Hartley coil with near-center tapping is inserted in the front socket. This type of inspection is for surface defects and plating thickness or adhesion tests. It can also detect grinding or hardening cracks, flaws in wire rope, and numerous other types of fault. The testing need not be observed with the meter as plugs and sockets can be fitted to the instrument for connecting a cathode-ray oscilloscope or automatic recording equipment.

The combined unit

The combined inductance-capacitance unit shown in Photo B is a high-frequency unit extremely sensitive to slight variations in texture and surface conditions of materials.

The operation of this unit is somewhat different from that just described; the discriminating sections are frequency-tuned so the device is actually frequency-modulated. A series of tuned circuits in cascade feed a discriminator circuit and a vacuum-tube

voltmeter. A Hartley coil is plugged into the instrument in the same way as in the inductance unit. The known specimen is then inserted into this test coil and the oscillator is adjusted to the frequency of the tuned circuits or to a suitable harmonic. A variable capacitor in parallel with several fixed capacitors is fitted to give the oscillator a suitable frequency range for the testing to be done.

Variations in composition, position, strains, stresses, defects, cracks, fissures, hardness, and even size of the sample can be used to vary the meter reading. For many tests, such as surface defects in ball or roller bearings, injection pump needles, textile machine needles, etc., the specimens can be fed past the detector at a very high rate, and the results can be observed on a cathode-ray oscilloscope while simple relay circuits can be used to reject faulty parts.

Photo B shows the instrument being used to indicate the stress-strain relationship in a sample of steel under tension in the machine. This setup is actually a static test, but the instrument can also be used for high-speed dynamic testing for tension, torsion, or compression. A cathode-ray oscilloscope then shows the actual stress in the sample, not merely that which is imposed by the machine. Another feature of this electronic stress detection

is the instrument's ability to tell the difference between tension and compression and also reversing torsional stress.

The capacitance comparator

The capacitance unit is shown in Fig. 2 and Photo C. This instrument is pro-

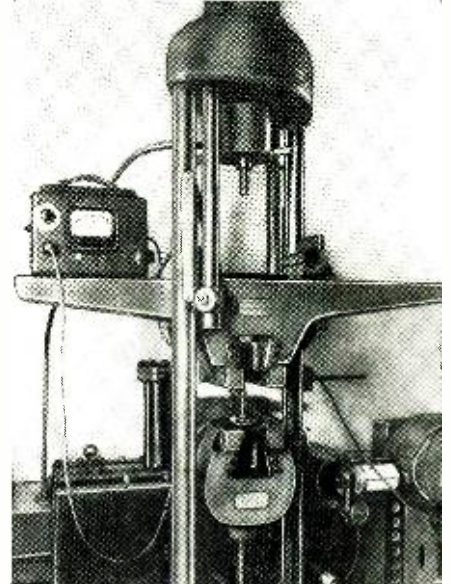

Photo C—The crystal-controlled capacitance unit in a setup for measuring thickness variations of .00001 inch.

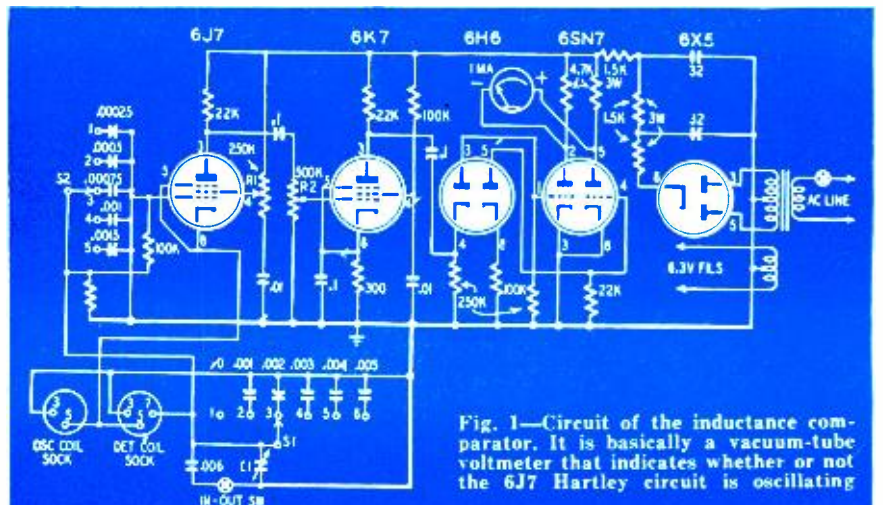

Fig. 1—Circuit of the inductance comparator. It is basically a vacuum-tube voltmeter that indicates whether or not the 6J7 Hartley circuit is oscillating

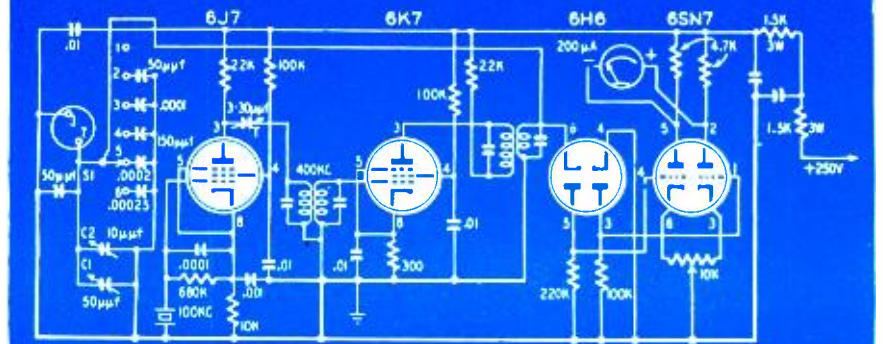

Fig. 2—Schematic of the capacitance comparator. The circuit is adjusted so the slightest change in capacitance of the pickup registers on the voltmeter.

Crystal Spots Radiation

Even in the simplest circuits the cadmium sulfide crystal is highly sensitive as a radiation detector

THE latest of the so-called semi-conductors to make the news is cadmium sulfide (CdS), which promises to become an important research and industrial tool because it can be made a very sensitive detector of various types of radiation. It will be especially useful for high-speed automatic X-ray inspection of industrial products.

These photo-sensitive CdS crystals are sensitive to both electromagnetic radiation (from the yellow region in the visible spectrum up to X-rays and gamma rays) as well as to high-energy particles (electrons, protons, and alpha particles). A polarizing voltage applied to the crystal makes it sensitive to ra-

diation, and, over a rather wide range, the photo-current is proportional to the applied voltage. (The electrical resistance of the crystal also varies with the intensity of applied radiation, but this is not always linear.)

Most important is the fact that the photo-current varies from crystal to crystal. In some crystals the photo-current corresponds to the number of free electrons produced in the crystal in a second (as in ionization chambers), while others the sensitivity may be as much as a million times greater.

The photo-current persists for a short time after the radiation is stopped. Generally the persistence is greater with greater sensitivity. In

some insensitive crystals the conductivity may decay within a microsecond after excitation stops, while in sensitive crystals the decay time may be measured in seconds or even minutes. In crystals where the photo-current is not proportional to the exciting radiation, the persistence still depends largely on the amount of excitation energy.

The CdS crystals also emit a reddish glow when irradiated. The amount of glow varies from crystal to crystal. The more sensitive crystals have a

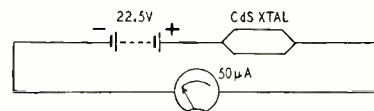

Fig. 1—Simple detector circuit using the crystal. When radiation hits the crystal, current through meter jumps.

greater output of light, while weakly luminous ones produce only a small change in conductivity. This fact is most important, because it means that crystals may be selected for any particular use before they are fitted with electrodes.

How it works

The reason for this unusual optical and electrical behavior of these crystals seems to depend on dislocations in the crystal lattice. In simplest terms, a crystal of any kind is different from other forms of matter because the atoms which make it up are arranged in orderly geometric patterns. Even extremely small dislocations in this structure seem to have a great effect on the luminescence and conductivity of these

L-C COMPARATOR AIDS INDUSTRY (Continued from page 35)

vided with a vertical bench comparator shown in the photo and used for reference checks with standard gauges. The operation of this unit is basically the same as that of the combined unit, except that it is much more sensitive and more carefully assembled. There is little difference in the circuit except for tube selection and voltage control.

As a detector of movement, this instrument has limitless uses. It has been used to detect movement in concrete dams, to detect vibration in machines, to control tool positions, to control machinery for boring mine shafts, and to inspect turbine blades both during manufacture and while assembled and rotating at high speeds. It has been used to measure the deflection of a 2-inch steel bar when a bee alighted on one end. In this case the deflection was $7 \frac{1}{2}$ gstrom units (100 million Angstrom units make 1 centimeter).

Its circuit is extremely simple and uses very old fundamental circuits. Even without voltage regulation its stability is very good.

The 6J7 crystal oscillator produces a 100-ke signal. This is multiplied to some suitable higher frequency by the tuned plate circuit. In the diagram this circuit is marked 400 ke (the frequency most often used in industry), but any other harmonic can be used to suit any particular purpose.

The 400-ke signal is amplified by the 6K7. The tuned circuit in the plate of this tube is unbalanced—its primary is tuned to 400 ke, but the secondary is

tuned externally by the operator by selecting an appropriate capacitor with switch S1 and varying C1 or C2. The capacitance pickup, which is designed to suit the particular test being made, is in parallel with these capacitors.

The 6H6 and the 6SN7 circuits make up a vacuum-tube voltmeter. The operator tunes the 6K7 plate circuit to produce a zero reading on the meter (the meter itself is not a zero-center instrument, but its scale is marked with a zero center). Any increase or decrease of the capacitance of the pickup then makes the meter needle move either to the right or left of the zero reading, depending on whether the change is an increase or decrease in capacitance.

The sensitivity of the instrument can be adjusted to any convenient value, but it is usually fixed so that a change of 2 μ f in the pickup will produce a deflection of 100 mm on the meter scale.

All of these instruments can be used for accurate quantitative measurements, but their greatest advantage is that they are easy to use for simple accept-reject tests for industrial quality control, even by unskilled operators. They are all housed in the same size cabinet, the heaviest weighs 16 pounds, and their power consumption is only 30 watts. They are built to withstand even the hardest abuse.

—end—

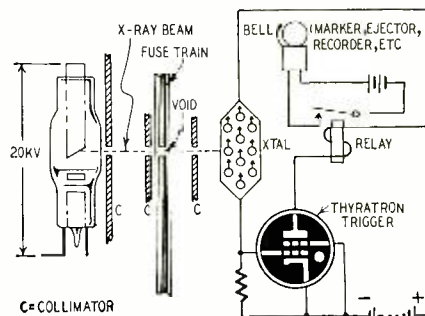

Fig. 2—Setup for testing powder continuity in a fuse train. Fuses can be checked as fast as 60 feet per minute.

CdS crystals. To make crystals with specific properties, it is advantageous to produce these dislocations systematically.

When the crystal is not excited by radiation, the electrons are firmly bound to the atoms within the structure and there are no freely moving charged carriers to make up a current. When radiation is applied, some of the electrons absorb enough energy to be able to break away from the atoms and, if a polarizing voltage is applied to the crystal, a current flows. During this high-energy state, each electron that leaves the crystal at the anode is replaced by one that enters at the cathode, so that the amount of current depends on the number of electrons that are in the excited state. After a time (depending on the type and number of defects in the lattice) the excited electrons return to their normal state. In this process the energy which they picked up during radiation is emitted as luminescence. Luminescence and conductivity are thus closely related. The relation between sensitivity and persistence also becomes clear with this explanation.

Because it is highly sensitive even in the simplest of electrical circuits, the CdS crystal makes a good detector of all types of radiation. A CdS crystal hooked up to a single battery and an indicating meter can detect radiation intensities so weak that would otherwise require considerable apparatus.

Some useful circuits

Photo A shows a little pocket-size detector using a CdS crystal. Its circuit, which appears in Fig. 1, consists merely of the crystal, a 22½-volt hearing-aid battery and a microammeter. This device was built by Immanuel Broser and Ruth Warminsky at the Kaiser Wilhelm Institute in Germany. Credit is due them for much of the information which appears in this article. The smaller unit to the right of the meter case is a crystal holder. A small cylinder inside the holder takes several crystals, and any one may be selected for use by turning the cylinder so the crystal is in front of a small window. The crystal holder is separate so that instrument can be read at some distance from the actual point of measurement to protect the operator from harmful radiation.

In this detector the crystal can be selected for a variety of uses. For example, one is for measuring light, another is for measuring the intensity of X-rays, and a third is for detecting weak gamma rays. This gives even this little pocket instrument an extremely wide range.

The instrument could be made even more sensitive by using a higher-voltage battery. The only thing which limits the amount of voltage that can be applied to the crystal is that it begins to heat up when too much current flows through it.

Photo B shows a setup devised by the General Electric X-ray Corporation

using a CdS crystal and X-ray machine to check the product level in canned baby food. A fine beam of X-rays comes

spection methods. In the case of the canned goods, as many as 600 units can be inspected per minute while the fuse

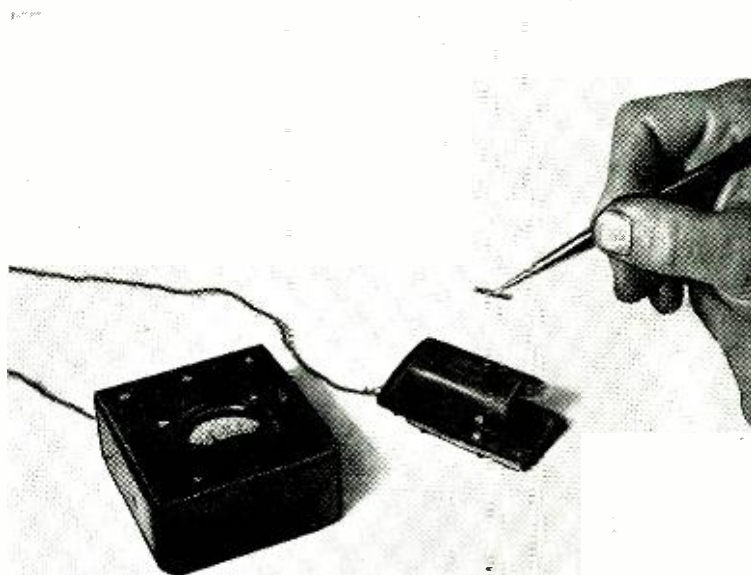

Photo A—This small portable radiation detector uses a CdS crystal. The meter and batteries are in the case at left, the unit at right houses the crystal.

from the generator on the left of the cans, and the crystal detector is at the right. This setup is only a pilot model, so the detector only operates the small neon lamp mounted on the crystal each time a bad can goes by. In actual production the detector would operate a reject lever or similar device. Fig. 2 shows the circuit of a similar setup used to check for defects a powder train of the type used in blasting fuses.

This crystal method will perform at much higher speeds than previous in-

goes by at the rate of 60 feet per minute. Because the crystals are so sensitive, very little if any amplification is needed, and fairly low-intensity X-rays can be used.

Another application which offers great promise is the control of the X-ray itself. In experiments at G-E X-ray, the output of the crystal has been used in a feedback arrangement to control the output of the X-ray generator and stabilize the beam.

—end—

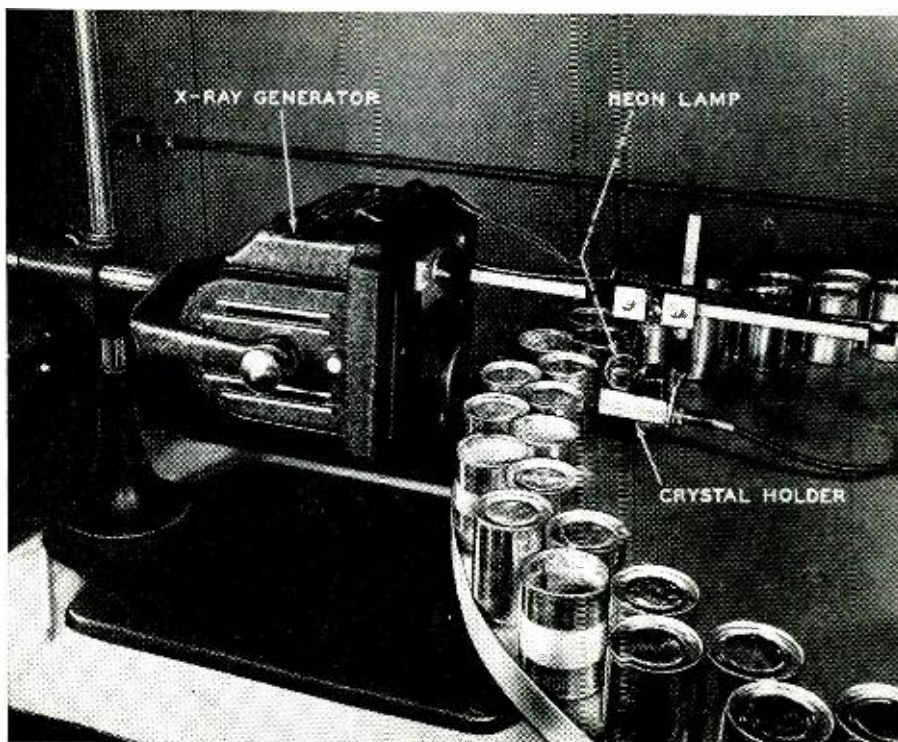

Photo B—A pilot setup for inspecting canned goods. X-rays are beamed through the cans to the crystal at right. Neon lamp indicates if a faulty can passes.

How an Electronic Brain Works

Part IX—Some electronic circuits for computers and how they are used for adding and subtracting

By EDMUND C. BERKELEY AND ROBERT A. JENSEN

IN THE previous article we began the discussion of an electric brain to be built around electronic tubes instead of relays. We discussed the storage information in the form of the state of a flip-flop, or pulses circulating in a delay line, or magnetized spots on a magnetic surface, or charges on the screen of an electrostatic storage tube.

But how do we compute? As soon as we have arranged to read, write, and erase information at electronic speeds, we need to consider how to compute with electronic elements.

For computing purposes, a unit of information is represented as a pulse, either a rise and fall of an otherwise constant voltage, or else a fall followed by a rise. We will call the first kind a positive pulse or a 1, the second kind a negative pulse or a -1, and the absence of a pulse a 0. See Fig. 1.

In a computer, the pulses are usually of a standard duration, and may be for example $\frac{1}{2}$ of a microsecond long and spaced $\frac{1}{2}$ of a microsecond apart. In this case the pulse repetition rate would

be 1 megacycle per second. In some computers, 1 and -1 pulses are both treated as the presence of information, the binary digit 1, the logical truth value 1, or "yes"; while 0 is treated as the absence of information, the binary digit 0, the logical truth value 0, or "no."

Phase inverter

The first computing element we need to consider is a *phase inverter*. In computer work, a phase inverter changes a positive pulse to a negative one, or a negative pulse to a positive one, that is, "inverts" the pulse. See Fig. 2. In this figure, and in Figs. 3 to 8, part *a* is the circuit diagram; *b* is its block diagram representation which we use for convenience; and *c* is a function table that indicates what the circuit does. Any grid-controlled electronic tube can act as a phase inverter.

Logical AND circuit

The next computing element we need to consider is called a "logical AND circuit." This is one of the meanings of

the electronic term "gate." See Fig. 3. In this circuit, a pulse appears on the output line if, and only if, two pulses come in simultaneously on two input lines.

A tube with two grids, normally cut off with either one or no pulses, is one of the forms which a logical AND circuit can take. The reason for the word "and" is that we have a pulse on output line C if and only if we have a pulse on input line A and on input line B. This (with emphasis on the idea "both") is the regular meaning for "and" in logic. This type of circuit may take many forms with and without electronic tubes.

Logical OR circuit

Another computing element is called a "logical OR circuit", sometimes called "buffer." It allows a pulse on the output line if a pulse comes in on either one or both of the two input lines. See Fig. 4.

A tube with two grids, which is normally conducting, is one of the forms which a logical OR circuit may have, although there are others. The reason for the word "or" is that a pulse is on output line C if a pulse is on input line A or if a pulse is on input line B, or both. This nonexclusive meaning of the word "or" is its regular meaning in logic.

Logical EXCEPT circuit

Another computing element is called a "logical EXCEPT circuit," or inhibitory gate. In this a pulse is allowed out on the output line if a pulse comes in on a specified one of the two input lines *except* if a pulse comes in at the same time on the other input line. See Fig. 5.

The circuit shown in Fig. 5 will act as a logical EXCEPT circuit. Its constants are chosen so that when A is not pulsed, whether or not B is pulsed, still there is no output on line C. If A is pulsed and B is pulsed, the two pulses coinciding in time and of opposite phase eliminate the pulse on line C. If A is pulsed and B is not pulsed, then the pulse goes on through. Other circuits besides that shown in Fig. 5 are of course possible.

Electrical delay lines

The computing section of an electronic computer also uses an electric delay line of very short delay, such as one pulse time, or a few pulse times. A circuit that does this appears in Fig. 6. These are different from the long sonic



Fig. 1—Pulses are used in electronic computers to represent information. A positive pulse may mean +1, a negative pulse -1, and no pulse 0. Other pulse combinations are sometimes also used.

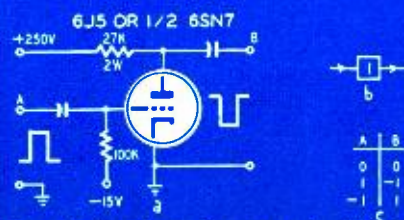

Fig. 2—A phase inverter circuit for computers. Part *a* is the circuit, *b* is its symbol for block diagrams, and *c* is a function table for this circuit.

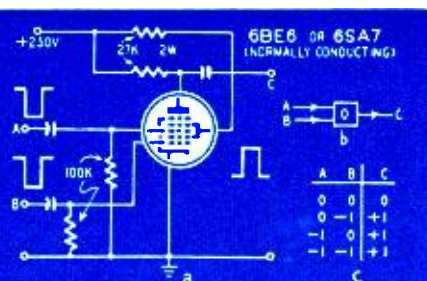

Fig. 3—A logical AND circuit, or gate. Output pulse appears at C only when inputs appear simultaneously at A and B.

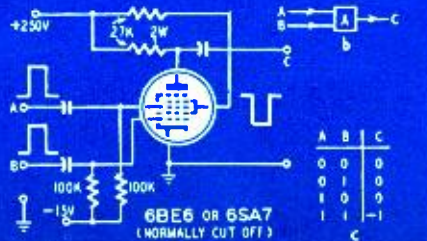

Fig. 4—Logical OR circuit, or buffer.

delay lines such as the mercury tanks described in the previous article, because the purpose of the short delay line is not storage but computation. Short delay lines are important because pulses sent into the various parts of an electronic computer must arrive at the various points just when they are needed. For example, in the Bureau of Standards Eastern automatic computer,

of microseconds and pulses are timed to be safely within the planned intervals.

Half-adder

Now how do we take these various computing elements and begin to do computing with them?

The first thing is to assemble these elements so that we can add two binary digits. Suppose there are two input lines A and B, and either one may bring in a binary digit that may be 1 or 0. Suppose that we have two output lines, one of them S, that will give us the sum without carry, and the other C, that will give us the carry. The function that we want to express is the result of adding two binary digits: $A + B = C, S$, where $0 + 0 = 00, 0 + 1 = 01, 1 + 0 = 01$, and $1 + 1 = 10$. See Fig. 7.

To make a half-adder circuit, one logical AND circuit, one logical OR circuit, and one logical EXCEPT circuit, combined as shown in Fig. 7-a, are sufficient.

Adder

But we are not finished, because a previous addition may have given a carry that has to be taken into account. The circuit which will perform complete binary addition is called an *adder*. See Fig. 8.

Now let us trace through the adder circuit with some numbers and see what actually happens in the sequences of pulses on the several lines in the circuit.

The digit 1 will represent a pulse (assumed to be positive or negative as the circuit requires), and the digit 0 will mean absence of a pulse at the proper time. At the same time the digits 1 and 0 will represent information that we desire to compute with.

Suppose we write a binary number (or more generally any set of binary digits) in the ordinary way (with the smallest ranking digit at the right) on any circuit line where the pulses are traveling from left to right. Then the binary number will be attended to as a pattern of pulses by the circuit in just the sequence from right to left that we ordinarily deal with in arithmetic. At the same time the number will show the sequence of pulses in the order that they are handled in the circuit.

As an example of using the adder, let us add 101 (one 4, no 2 and one 1 in binary, or 5 in decimal) and 1011 (one 8, no 4, one 2, and one 1 in binary, or 11 in decimal). We write the two numbers on the input lines A and B (See Fig. 9) and now we set out to see what happens.

At the first pulse-time, the pulse (the 1) on the A line and the 1 (another

pulse) on the B line go into half-adder No. 1, and give rise to no pulse on the S line (sum without carry) and a pulse on the C line (carry). The 0 on the S1 line goes into the second half-adder without delay; but the 1 on the C1 line goes into the one-pulse delay and so it is held back one pulse-time. As a result, at the first pulse-time, 0 and 0 go into the second half-adder; and so its output is 0 for the first digit of the true sum, and 0 for the carry. The 0 for the carry circles round the loop and comes up to the entrance of the one-pulse delay.

At the second pulse-time, 0 and 1 go into the first half-adder, and give rise to a 1 on the S1 line and a 0 on the C1 line. The 1 on the S1 line goes into the second half-adder without delay. Now the delayed previous carry (with no conflict from the absence of pulse that came around the loop) now issues from the one-pulse delay. So 1 and 1 now enter half-adder No. 2, and from it issues a 0 on the sum line S2 and a 1 on the carry line C2 which circulates around the loop, and enters the one-pulse delay so it will be ready for the next pulse time.

At the third, fourth, and fifth pulse-times, each of the proper operations takes place similarly, and so we get out of the second half-adder exactly the sum that we desire.

Subtractor

Now how do we manage to subtract? A circuit that will subtract is shown in Fig. 10, using the constituents of an adder, and a logical EXCEPT circuit. The word "minuend" means "the number to be diminished." The word "subtrahend" means "the number to be subtracted."

Let us test this circuit by subtracting five from eleven, or in binary subtracting 101 from 1011. The pulses appear in succession on each of the lines in the diagram, as shown. By following through the circuit, remembering what each stage does, we see that exactly the right answer, 0110 or six, appears on the output line marked "difference."

Acknowledgement is made to Henry W. Schrimpf for a number of the circuits and ideas in this article.

In the next article we shall take up the multiplication and division of binary numbers using electronic circuits and begin the discussion of the control of an electronic computer.

(continued next month)

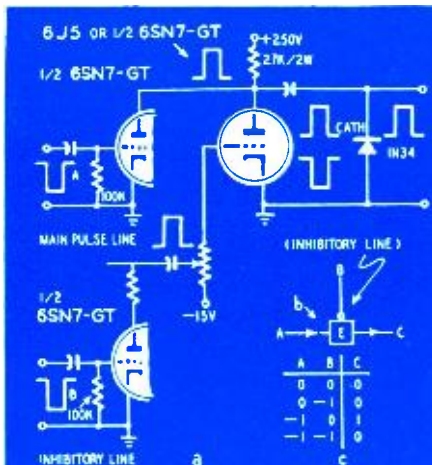

Fig. 5—A logical EXCEPT circuit. The pulse input at A appears at output C except if there is a pulse at input B.

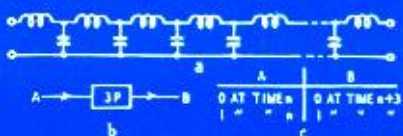

Fig. 6—Electrical delay line as used in computers. The 3 in the block symbol denotes a delay of three pulse times.

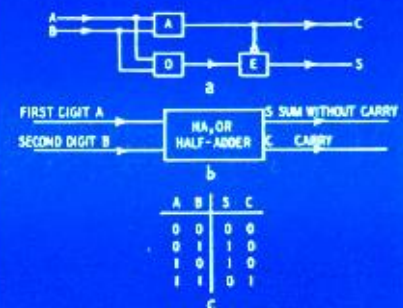

Fig. 7—This half-adder circuit gives the result of adding two binary digits.

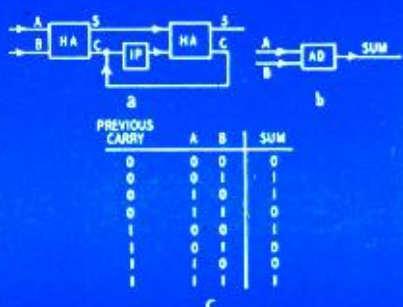

Fig. 8—An adder circuit is made up of two half-adders and a one-pulse delay.

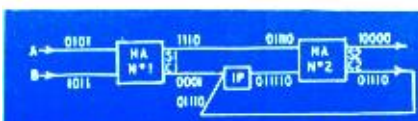

Fig. 9—The numbers on this adder show how 0101 is added to 1011 to get 10000.

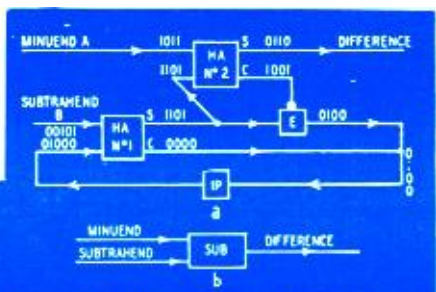

Fig. 10—Diagram of a subtractor. This one is taking 101 from 1011 to get 110.

Don't Touch Those Screws!

A fast method for diagnosis and alignment

By JOHN D. BURKE*

YOU can assume that one or more—or all—the screws on a radio set have been turned if you know that "Cousin Fred" tried to fix it before you came on the scene.

But how about you? Haven't you also an itch to twist a few?

Please—please—don't do it! Not until you are qualified to do the turning. And not even then, till you know for sure they need turning.

And don't kid yourself just because you ended up with the set playing that it is playing correctly. There is the little matter of the right i.f., for which the r.f. and oscillator of this set have been designed. If the i.f. is wrong, the set won't track properly. You will get some stations, but not others. You may end up with some weird whistles.

A repairman must understand alignment, for it plays a big part in the proper operation of the set.

If you must make a choice—shall you get a signal generator first, or a signal tracer—the generator is the most important for the beginner. The higher in frequency it goes, the better.

* This article is based on a chapter in *Rapid Radio Repair*, a book recently published by the author.

I happen to use a *tuned* signal tracer and have developed a different method of alignment from the conventional.

Instead of aligning i.f. stages with a generator, I let the broadcast signal of a local station beat against the local oscillator of the set (in other words, I tune in a station) and *check with the signal tracer* (tuned to the frequency that set is supposed to use for its i.f.), to see if the same signal, at proper strength, frequency, and quality, appears at each point of the i.f. circuit, and at the detector. This is easy to do, and may be done in the course of other tests with the tracer—and before needed repairs in the audio, for instance, have been completed.

In fact, this method makes it possible to align a dead set. Any other method of alignment usually requires that you hear and measure the final audio output of a radio; it presupposes that the set is in operating condition, and that you are just touching up the alignment as the last step before finishing the job.

However, if a set comes in with a defective loudspeaker or output transformer, for example, and the customer wants an estimate, there are likely to be other troubles in the set, and you want

to be sure. With this method you can test the set in every respect right up to the point of breakdown. And in some cases I inject a signal in some fashion into the rest of the set after the breakdown point. For instance, I test the customers' loudspeakers by hooking them to the output from my signal tracer, which, being tunable in the broadcast band, serves very well as a comparison receiver.

While we are discussing the price of the job, I can be adjusting his various trimmers so as to perfect the set's alignment.

I. f. alignment

Manufacturers' instructions for alignment (by signal generator) call for injecting the signal at the i.f. tube (second or third i.f. if the set has them), and working back toward the mixer.

My method calls for working from the mixer back. To put it another way, one listens in to the desired signal, and turns the screws that need turning to clear the road for that signal to reach the second detector.

Better yet, it is possible to tell whether a radio is in approximately correct alignment without making any connection of any instrument whatsoever to the set itself!

How is that?

Every radio, even the tiniest camera-type portable, produces such a strong i.f. signal as a result of the gain in the i.f., that it radiates.

A signal tracer of the tuned type is a tuned radio-frequency radio (with meters). It is tunable down to around 100 kc, and up through the broadcast band.

With one hand you sweep the tuning dial of the tracer across the i.f. that the set in question is supposed to use—above and below that point. With the other hand you probe with the lead connected to r.f.-i.f. test on your tracer, and *even outside the cabinet of the radio* you will be able to detect signal at i.f. (Of course you must be on a station with your radio.)

Generally I use an unshielded lead for r.f.-i.f. tracing to get better pickup than you get with a shielded lead.

Presto! By this method, when the customer walks in you can, in many cases, turn on his set and in a few minutes say to him: "The signal is going halfway through your set. There is probably no more than such and such wrong with it. The repair will be \$—, at the most."

Meantime the set has been sitting there not making a sound. You can even mystify your customer by letting him hear his own little set playing into a big speaker, often sounding much better than the original—and no wires! "Is that *my* set playing?" Time and again

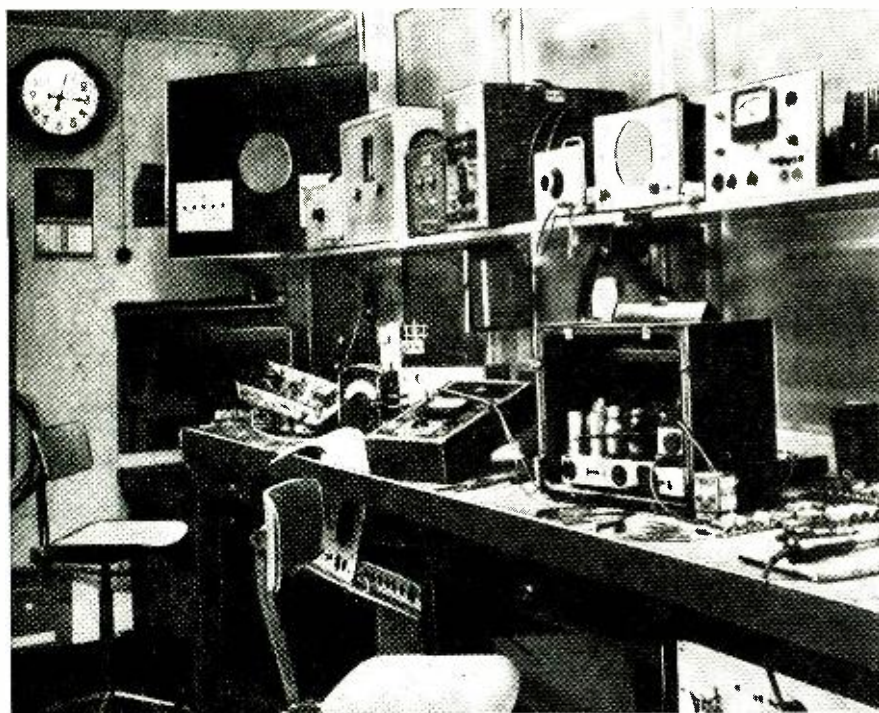

A well equipped service bench. This one is at Radio Peeters, Amsterdam, Holland.

I hear that, and I explain as well as I can.

This situation requires that the set oscillator be working. If it is not working but the rest of the set is, then it can pick up your signal generator at its intermediate frequency, even from a distance. This is common practice in repair shops.

A tuned signal tracer eliminates search in the books for an unknown i.f. If you get nothing in the 450- to 470-ke region, you tune down to 262 ke, and in the case of some old-timers, still lower. Of course, if the set has been aligned on a wrong frequency, you may have difficulties, but wrong tracking will show up that trouble immediately.

You have no trouble with harmonics or images, as you do with a signal generator. You do not disable the oscillator to align an i.f. stage.

The greatest benefit of all is that you work with a broadcast signal, not the 400-cycle note. Thus you can check for distortion, rattles, loss of frequencies, etc., while doing the alignment.

The old-fashioned method of alignment calls for an output meter across the loudspeaker voice coil. That method is still good. However, for years I have relied either on a vacuum-tube voltmeter connected to a.v.c., or on the signal tracer or on my ears.

How about the last? I have satisfied myself that it is practically impossible to improve on an alignment done by ear. For one thing, if you peak a set (eliminate background noise) on a *weak* station, that set must be adjusted to its maximum gain. This done, all strong stations ride in perfectly.

The same goes for alignment by oscilloscope. You may object: What about high fidelity? How about wide bandpass sets (AM sets)? The answer is simple. A.v.c. action on any r.f., mixer or i.f. stage broadens the bandpass of that stage enough to pass the higher audio frequencies.

In television it is a different story. Very wide hands must be passed, and i.f.'s are stagger-tuned. As for FM, I note that even the manufacturers are calling for peaking their i.f.'s for maximum gain nowadays.

A few AM sets have wide bandpass built in; either by a switch to cut in and out another winding in an i.f. transformer, by a mechanically operated variable coupling device, or by using resistors in parallel or series. Generally speaking, the set is peaked to maximum in "sharp" position. Then high fidelity takes care of itself.

Checking sets with a.f.c.

For experience, and to prepare you for some models of television and FM sets, it will be a good thing if you get a chance to work on some sets with automatic frequency control. The service technician must study these circuits to understand how they take a voltage off a discriminator tube (which takes its signal off at the same point as the regular detector) and feed it to an auto-

matic frequency control tube, which has its plate, or cathode, circuit linked to the oscillator of the set.

Put simply, variations in tuning on the dial, away from dead center on a station, produce either a positive or a negative voltage (depending on whether the dial is set above or below the right frequency) from the discriminator. This tube works (at slow motion) just like the discriminator in FM sets—with the difference that it produces variable d.c., whereas the FM discriminator produces audio.

The d.c. voltage from the discriminator, applied to the grid of the a.f.c. tube, varies its plate current. Variations in current through a tube change its reactance. Result: the local oscillator shifts to approximately the right frequency to beat with the station which is *almost* tuned in.

The set will align normally when a.f.c. is turned off. Then you have to adjust the discriminator so that it will pull in stations an equal distance above or below on the dial.

Beginners spend a lot of time screwing series padders in and out. Here are a few tips. Assume that they are right all the time (provided the padder is down in its usual out of sight position on the chassis). Tamperers play around with screws on the i.f.'s and tuning gang mostly. Turn the series padder only *after* you have the right i.f., and *after* the oscillator parallel trimmer seems unable to correct the tracking within its normal adjustment range.

Any set on which you cannot peak the trimmers without the set breaking into regeneration (squealing, etc.) has something wrong with it. Exception: I often find that people have "aligned" the i.f.'s up near or on the frequency of

a station around 550 ke. Then anything is possible. If you have the right i.f., but cannot peak without regeneration, then the set has something wrong with it. Examine all the possibilities for undesired oscillation (shielding, lack of bypassing, bad tubes, loop too near i.f.'s, etc.). That set was capable of maximum gain without oscillation when it was built, and you are confronted by a repairable condition.

Powdered iron core coils (permeability tuned) sometimes develop shorted turns. Such a coil with shorted turns loses inductance, not to the tune of so many turns, but much more. So, you may come across broadcast band oscillators operating wildly way up in the amateur, police, and even high frequencies due to a shorted coil. Those are the times when the oscillator channel of a good tuned signal tracer will let you know what has happened and why.

Powdered iron tuning circuits, on the other hand, do not get out of adjustment frequently. As in the case of the screws on other sets, you will profit little by turning these core screws very much unless you know that they have been tampered with.

The problem of alignment includes many other things for which there is no space in this article. Like anything else, aligning becomes easier with practice. It is possible to go along in a rut year after year without seeing how to save time. I hope this article will come as something of a stimulus to old-timers as well as to the younger generation in our field.

In general: *If a radio set has not been tampered with, it probably needs no realignment. Smoke that in your pipe.*

—end—



"I guess they've signed off for the night"

Suggested by J. P. Sandlen, Hamilton, Ohio

With the Technician

TRENDS IN SERVICE LAWS

Legislation appears to be the early summer fashion in areas faced with television service problems. New York City, as usual, has a bill under consideration—at the time of writing there was actually a bill and a half in the offing.

The bill is a modified form of the earlier Keegan proposition, which would call for licensing all technicians and service organizations and would appoint a city czar to promulgate rules and enforce them. The near-bill is a proposition by A. B. Z. Silver, Brooklyn assistant district attorney, to set up a city agency to hold in escrow funds paid by television owners on television service contracts.

Complete records would be kept by the agency so that if a customer considered his service organization unsatisfactory, he could switch the remainder of his contract period to another one. Should the contractor go out of business (which would be less likely if his receipts were spread out over the 12-month period) his unexpired contracts would also be turned over to other companies. And if a service concern found it impossible to get along with a customer, it could also turn in the contract, to be finished by some other "lucky" service organization.

Rhode Island has actually passed a licensing ordinance—aimed purely and simply at the television service contractor. Its text appears elsewhere on this page.

Other license proposals have appeared at widely scattered points. The city council of Miami recently rejected a proposed ordinance which would cover the construction, installation, and maintenance of radio and television apparatus. It was submitted by a group called the Radio and Television Technicians Guild of Florida, and provided for a board of examiners, licenses based on technical qualifications, and inspections of outdoor antennas by the city's electrical inspectors. A licensing bill is being advocated for Wisconsin as well. Massachusetts proposes the following for antenna installers:

"Any person installing an aerial or any device connected with the operation of a domestic or business television set shall pass an examination and shall be registered with the electrical board of the division of registration.

The board shall pass on all types of antenna and prices to be charged for the installation of same.

In New York State, television has become one of the chief subjects of legislative debate. After passing one bill to ban the use of televisers in motor cars, and another forbidding attachment of antennas "or any other wires"

to any fire escape or to any soil or vent line extending above the roof of a building, the Legislature sees the Levine Bill, which proposes state-wide licensing, looming up on the horizon. This follows the O'Connor Bill, described in our May issue, which was found unconstitutional in the form in which it was drawn.

The trend would seem to indicate that a number of acts designed to regulate or control radio and television servicing are likely to be passed. Some of these, like the Rhode Island law, may protect the television set owner and the honest technician. Others may increase the revenue of the municipality enforcing them. Still others, not aimed at the real problem, are no doubt destined to annoy authorities and service organizations alike till they are either repealed or die of nonenforcement.

OLD STORY, NEW REASON

New reason was given recently by a television contract service organization for going out of business. The Hano Television Maintenance Company of New York City suspended operations because of the failure of dealer clients to make payments to the company on the contracts held from them. Dealers have been protecting themselves against failure of the service contractor by paying him in installments, though the customer almost invariably pays the full amount at the beginning of the contract. Mr. Hano stated that back payments owed by dealers amounted to about \$75,000, and that the situation was further aggravated by the business failure of six retailers who had used his company as a servicing agency.

Television set owners would not be inconvenienced by the liquidation of his company, Mr. Hano said, as the dealers could simply transfer contracts and pay the new contractor some of the money that his firm was unable to obtain. He felt that dealers were willing to pay but were not able to because of being heavily overloaded with TV stocks.

NATIONAL RADIOMEN MEET

The second meeting of the new national radiomen's organization was held Sunday, March 4, at the Drake Hotel in Philadelphia. Some discussion as to the correct name of the body was closed by confirming the title: National Electronic Technicians and Service Dealers Associations (NETSDA).

Distinguished members of the industry, including the service department heads of two of the country's largest television set manufacturers as well as representatives of other

branches of the radio industry, were present to wish success to the new organization.

Considerable discussion on organization and membership took place and plans were laid down for carrying on educational and promotional work in that direction.

The third general meeting was held in New York City, April 1. A charter for the organization was discussed and a preliminary draft was referred to a committee for further development.

The treasurer, Vance Beachley of Harrisburg, Pa., reported that six organizations had forwarded membership dues since the last meeting. The publicity director, Mr. Marshall, pointed out that a recent report on a radio meeting in Philadelphia contained material which might be considered slanderous to the radio technician. The publicity committee was instructed to write to the reporting organization, pointing out the adverse effects of such publicity and urging them to try to hold down such publicity in the future. Dave Krantz, of Philadelphia, reported that the organization emblem was in the hands of the engraver, and that other pictorial publicity material for the organization was nearly ready to turn over to the publicity committee.

LETTER PROMOTES MEETINGS

The Long Beach Radio Technicians Association (California) has a system of keeping members up to date which might well be copied widely. We have received a copy of a letter, which is apparently manifolded and addressed personally to each of the absent members by the publicity director, Harry Ward. It gives the highlights of the two meetings of the month and points out that it would be better for the member to attend meetings, rather than stay away and then call other members by telephone to find out what transpired.

The Association, which believes itself to be the oldest and largest service technicians organization in the country, has elected Hal Meyers president. Other officers are: Fred Abrams, vice-president; Les Huckins, secretary; Clarence Spencer, treasurer; Harry E. Ward, head of public relations; and Joe Martin, technical adviser.

Long Beach is one of the organizations which issues its own certificates of qualification. It requires that all technicians undergo a four-year apprenticeship before being issued certificates as fully qualified technicians.

RHODE ISLAND LICENSE ACT

The State of Rhode Island has licensed all persons selling television service contracts. The Act also provides for a \$2,000 bond. The text follows:

State of Rhode Island and
Providence Plantations

JANUARY SESSION, A.D. 1951

AN ACT Providing for the Licensing of Sellers of Service Contracts for the Maintenance and Repair of Radios and Television Sets.

It is enacted by the General Assembly as follows:

SECTION 1. No person shall engage in the business of selling service contracts for the repair and maintenance of radios, and television sets within this state without having first obtained a license therefor from the department of business regulation in the manner hereinafter provided.

SEC. 2. The department of business regulation is hereby empowered to grant licenses to persons engaged in the business of selling service contracts for the maintenance and repair of radios and television sets. It shall be the duty of said department to provide such regulations and rules for the conduct of such business as shall be necessary to effect the intent and purposes of this act.

SEC. 3. The fee for such license shall be \$2.00 per year and shall be paid to the general treasurer for the use of the state; and each person so licensed shall give to the general treasurer and his successors in office a bond, with two sureties approved by said general treasurer in the sum of \$2,000.00 with condition for the proper discharge of the services which he may perform by virtue of such license.

SEC. 4. Every person who shall violate the provision of the foregoing section shall be fined not exceeding \$500.00.

SEC. 5. This act shall take effect upon its passage and all acts and parts of acts inconsistent herewith are hereby repealed.

PRMA PICKS NEW OFFICERS

The Philadelphia Radio Service Men's Association has elected James Daly, former secretary, to the presidency of their association, to fill out the unexpired term of Tom Middleton. Mr. Middleton plans to start a service business of his own in Miami, Florida. William Hume was elected to fill Mr. Daly's place as secretary.

NEW YORKERS JOIN NETSDA

Radio service technicians of New York voted their organization, the Empire State Federation of Electronic Technicians' Associations (ESFETA), into the new national radio service federation, the National Electronic Technicians and Service Dealers Associations (NETSDA), confirming a tentative decision made at an earlier meeting.

The decision to join the national federation was the most important business of the annual ESFETA meeting, which was held at the Arlington Hotel, Binghamton, New York. Twenty-five members were present, representing eight associations.

Other business included special measures to protect the rights of member associations of the State Federation who might not wish to join the new organization, a discussion of the licensing situation, financial measures, and notice of constitutional amendments.

Officers elected for the 1951 term were: President, Wayne Shaw, Binghamton; vice-president, Sid Gent, Endicott; recording secretary, Ed Fisk, Rochester; corresponding secretary, Don Lissow, Rochester; treasurer, Ben

de Young, Ithaca. Jack Wheaton, Sam Marshall, Ken Brunneman, and Sid Gent were appointed delegates to the national organization.

OHIOANS DISCUSS SAFETY

"Safety in Your Store" was the theme of the Columbus, Ohio, Associated Radio Service Dealers' March meeting.

The discussion was led by members Fred Oberle, Don Blazer, and George Dykes, each of whom had prepared an individual paper on the subject. In this manner subjects were brought out that many members admitted they had never thought of.

PROTESTS OPS APPOINTMENTS

Television Associates, Inc., of Washington, D. C., at a recent meeting protested the reported appointment by the Office of Price Stabilization of a group composed solely of distributors to represent the TV service industry on pricing problems. The organization is working individually and through the National Electronic Technicians and Service Dealers Associations to secure representation for the service industry at all governmental hearings where their interests are involved.

About 200 persons, representing some 60 firms, attended the meeting.

Tubeless Oscillator Covers Audio to 2 mc

By EDWIN BOHR AND HAL FRENCH

THIS wide-range tubeless test oscillator—a variation of one used in a telemetering circuit—generates signals from low audio frequencies to well above 2 mc. To appreciate its simplicity, you need only to look at the diagram and photograph. Its components are a transistor, two resistors, switch, a tuned circuit, and a 22.5-volt battery which delivers less than 1 ma to the circuit. The simplicity of the transistor oscillator is one of its best selling points. Just try to design a vacuum-tube oscillator which uses so few components and requires such low battery power.

The absolute frequency range of the oscillator range depends upon the Q of the tuned circuit and certain other factors. The L-C circuit may be variable so that the output frequency may be tuned. For example, the secondary winding of an antenna coil and a 365-µmf variable capacitor may be used to cover the broadcast frequencies, or one side of an i.f. transformer may be used to produce a fixed frequency at 456 kc. The oscillator is modulated by transistor noise or hiss. Its signal tunes broadly on a receiver because of the wide sidebands produced by the hiss.

A 2-terminal oscillator sustains oscillations because of its negative resistance characteristics. Because a transistor can be made to exhibit this characteristic, this tubeless 2-terminal oscillator is possible.

In a conventional or positive resistance, the voltage drop across a resistor varies directly as the current as shown by the familiar Ohm's law formula $E = IR$. Positive resistance absorbs power from an L-C circuit and damps oscillations. If it were not for this effect, an L-C circuit would oscillate in-

definitely after being excited.

In a negative resistance, the voltage drop decreases as the current increases. It contributes energy to the natural period of oscillation by causing heavier

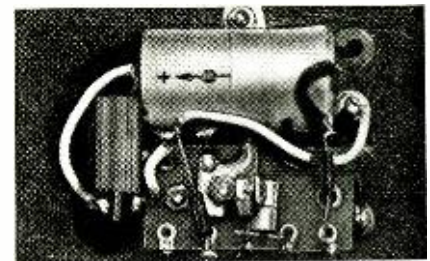

A rear panel view of the oscillator.

current to flow through the tuned circuit as the voltage decays. Such circuits will sustain oscillations only as long as the value of negative resistance is greater than the positive resistance. Therefore, it is necessary that high-Q tuned circuits be used—particularly if one set of components is used to cover a wide range of frequencies.

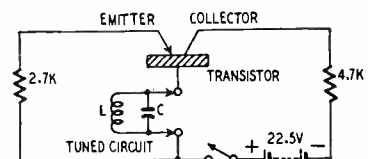

Circuit of the wide-range oscillator.

Commercial sockets were not available for the Bell Laboratories transistor used in the circuit so we used the makeshift mounting shown in the photo.

1 "Transistor Oscillator for Telemetering," Frank Lehan, *Electronics*, August, 1949, page 90.

—end—

Handling Test Leads

Unimpressive but important, they can help you make better use of your test equipment

By H. LEEPER

Don't lose your time and risk your temper by neglecting your test leads and prods. They are the eyes and ears of your test equipment—its only means of making contact with the world outside. Yet how many technicians pay little or no attention to these essential accessories, and so lose time—and prestige in the eyes of their customers—by trying to do their work with ragged, tangled, unkempt-looking leads.

You can even have real trouble because of beat-up leads. I have seen a so-called service technician remove an output transformer—drilling and punching out two rivets to get it off the speaker—simply because his test lead was broken inside the insulation where it connected to the pin jack at the instrument end, and so indicated an open primary. Frayed braid on coaxial leads can short the lead, giving false short indications, and sometimes causing real damage in certain rectifier and other circuits.

System will help in handling your test prods. A single instrument may

have several of them for various applications.

You can save time by placing them so they can be reached easily without fumbling through a nest of cables for the correct lead. There will also be less chance of plugging in the wrong lead.

The photos below show some hints—gathered from the author's experience—on the care and handling of the humble test lead.

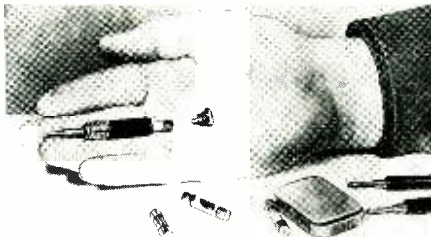

Photo C—Some types of test prods can be fitted with low-current fuses to protect the instrument. For some tests using leads only, protect the building fuses by using a 3-ampere fuse in the test prod.

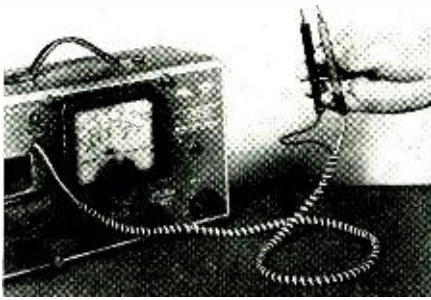

Photo D—A plastic telephone cord covering (obtainable at the dime store) will keep the test leads from twisting and getting tangled. Leave enough open wire at the ends for easy testing.

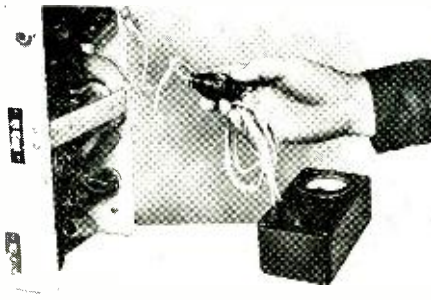

Photo E—If the meter is connected to the set under test for some time, as in checks for intermittents, a snap switch in one test lead may be convenient for starting or stopping the test at various times without disturbing the chassis.

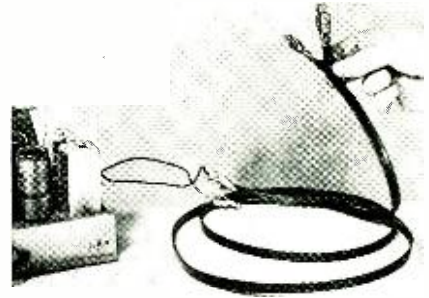

Photo F—A piece of TV ribbon line with clips on the ends is convenient for attaching a receiver output transformer to a PM speaker which is left in the cabinet. Do not use such leads in circuits carrying high voltages.

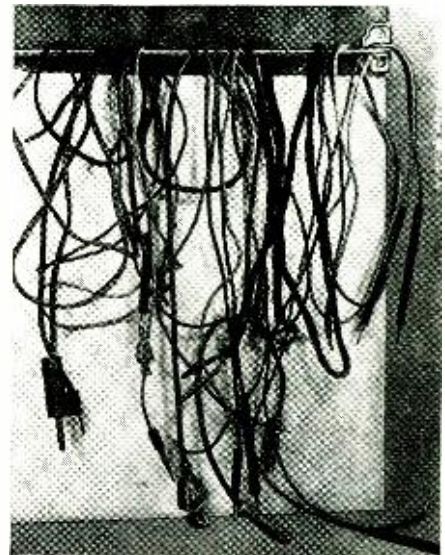

Photo G—A towel rack about 18 inches long mounted near the service bench will hold a number of test leads so they are easy to find, easy to get at, and do not get rubbed and dirty.



Photo H—Use a metal tooth brush holder to carry needle point prods and leads in the pocket or kit. The holder shown is about 7 inches long and an inch in diameter.



Photo A—Use a 6-inch length of No. 4 rubber covered wire to make a very simple test prod. Remove the insulation from both ends and grind one end to a point. Solder a piece of flexible wire to the other end and cover the joint with tape.

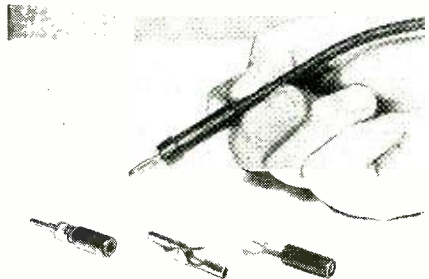

Photo B—Various types of commercial test leads are available. These have insulated handles and are fitted with banana plugs. These plugs will fit various types of jacks, such as pin jacks, spade jacks or alligator clips, which can be interchanged as required.

Electronics and Music

Part XII—Electrostatic mechanisms used in electronic tone generators

By

RICHARD H. DORF*

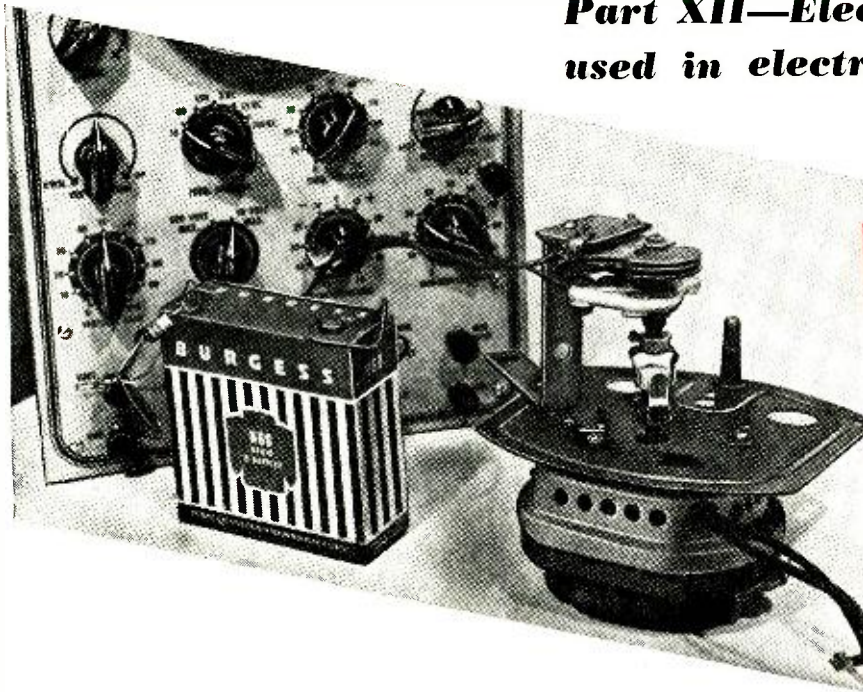

Photo A—This simple test setup shows how electrostatic organs work. An ordinary variable capacitor is connected to the shaft of an old phonograph motor. The electrical circuit appears in Fig. 1. Higher voltage or a larger-capacitance unit than the 10-30-mfd the writer employed gives very much greater output

IN THIS final article dealing with tone generators for electronic musical instruments, we shall take a brief look at a few more of the electro-mechanical methods. In general they are much more difficult for the individual constructor to make than the purely electronic product, but they tend to be more reliable once they are in working condition.

Electrostatic generators

The electrostatic system of tone generation is used in the Compton Elec-

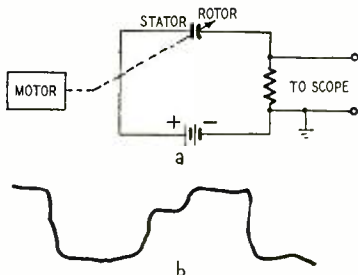

Fig. 1—Varying capacitance with a motor in the circuit of *a* produces the wave *b*.

trone, a British instrument which we hope to be able to describe in full in a future article. It is also the basis of most amplified reed systems, including the Wurlitzer, which we will explain fully at a later date.

Electrostatic pickups are based on the simplest principles of capacitance. A capacitor is a pair of conducting

surfaces in proximity to each other, separated by a nonconductor or dielectric. When a voltage is applied between the plates, there is a sudden rush of electrons from the positively charged plate to the negative one through the voltage source. Once all the electrons that can rush have rushed, the capacitor is charged—there is an excess of electrons on the negative plate and a scarcity on the positive.

The crucial point here is that the number of electrons that make the rush is determined by the magnitude of the applied voltage, the character (good or bad insulating properties) of the insulation between plates, the distance between the plates, and the area of the plates themselves. To distill things further, if the d.c. voltage and the dielectric remain the same, the distance between the plates and the distance between them determine the magnitude of the initial current flow.

Now let us set up a laboratory experiment such as we have pictured in Photo A and diagrammed in Fig. 1. A variable capacitor with its plates fully meshed is connected to a resistor and battery in series. The moment we connect them there is an initial rush of current from the positive plate through the battery and the resistor to the negative plate. In a small fraction of a second the capacitor charges fully and the current flow comes to a gradual stop.

Now we give the capacitor shaft a half turn or so. The area of the rotor which is between the stator plates is now smaller—there is less capacitance, just as if we had lopped off a piece of the rotor plates. Some of the electrons on the effectively smaller rotor plates are now crowded off and return through the resistor and battery to the stators, creating a little rush of current through resistor and battery in the opposite direction to the original charging current.

We will find, in fact, that every time we rotate the rotors and change the capacitance, there will be this rush of current, its direction depending on whether we decrease the capacitance (discharge) or increase it (charge).

Now we haul a motor out of the stockpile and connect the shaft to the shaft of the capacitor. When we start the motor the capacitor's rotors begin whirling at the same speed as the motor. And with each revolution the capacitance reaches a minimum (plates unmeshed) and a maximum (plates fully meshed). As a result, current through the resistor and battery reaches a maximum, first in one direction, then in the other. In fact, the current takes the form of a.c. In the actual experiment shown in the photo the resistor was

* Audio Consultant New York City

15 megohms, the d.c. supply 90 volts, and the capacitor a 10–30- μ f unit. The current through the resistor created a very small a.c. voltage, too small to measure. Since the motor shaft drove the capacitor at about 900 r.p.m., the frequency of the a.c. was equal to the r.p.m. divided by 60 (to reduce it to revolutions per second), in this case 15 r.p.s. or cycles. It was fed to the vertical input of an oscilloscope and the waveform appears in Fig. 1-b.

It is obvious that the waveform in Fig. 1-b is not a sine, but since the a.c. was at an audio frequency it could easily be heard when a pair of headphones were placed across the output of the oscilloscope amplifier. The waveform depends only on the shape of the capacitor plates.

With that in mind we can design electrostatic generators to order, in at least two ways. The first involves varying the effective plate area. The specific method is taken from L. E. A. Bourn's Patent No. 2,522,923, though Bourn's method is presented here only in bare principle.

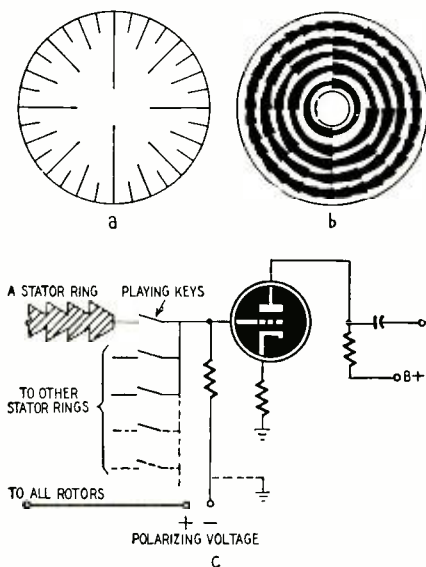

Fig. 2—Rotor *a* and stator *b* of one patented electrostatic instrument. The electronism at *c* is the input amplifier.

Fig. 2 shows the two necessary parts. A disc of insulating material at *b* has five annular rings of metal mounted on it. The rings are shown as the shaded push-pull sawtooth-shaped parts. This is the stator disc. Notice that the outer ring of the stator has 32 waveforms on it and each inner ring half the number of the next outer one. Each stator ring is electrically connected through a playing key to the grid of the first amplifier tube, as in *c* of Fig. 2.

The rotor appears in *a*. It is composed of a network of rigid wires mounted on a rim. The solid radial lines in the drawing represent the wires. All the wires are connected together and to the positive end of the polarizing potential, as shown in *c*. The rotor is placed parallel to the stator and very close to it.

Notice next that in the rotor there are radial wires of five different lengths.

The result is that the outer group numbers 32—the same number as the waveforms on the outer ring of the stator—and that their spacing is exactly the same as the stator's waveforms. The same holds true for each of the four inner rings.

Now let us set the mechanism in motion. When it is standing still, there is a constant capacitance between each wire of the rotor and the portion of an annular stator ring which faces it. As the rotor turns, each stator wire scans its wave pattern opposite. When a wire faces the wide portion of the waveform the capacitance is great; as it goes toward the narrow part the capacitance decreases. We thus have five continuously varying capacitors. Because of the 2-to-1 relationship in the number of waveform patterns and rotor wires between each ring and its neighbor, the outer ring's capacitance varies fastest, the next half as fast, and so on.

We thus have a mechanism and a circuit for refining the results obtained in our laboratory experiment. Because of the waveshapes on the stator, we can, by closing the appropriate playing switches, get from the output of the tube a note of the scale in sawtooth form over a range of five octaves. The speed of the disc determines what note it shall be. By providing twelve such discs, each rotating at an appropriate speed, we can make available five full octaves of notes. By placing six or seven annular rings on each rotor we can, with twelve discs, produce six or seven octaves.

The same trick can be attacked from another angle. In Fig. 3 we have a disc with a scalloped edge. Close to its edge and facing it edgewise is a small electrode. Connections are as shown in the figure. Now, as the disc rotates, its metal edge alternately approaches and draws away from the pickup electrode. The resulting capacitance between the two varies, and again an audio voltage appears across the resistor.

The electrostatic method has also been used extensively to make "electric pianos" and amplified reed organs. The method for a piano is illustrated in Fig. 4-a. A pickup screw is mounted close to the string and the polarizing voltage is connected. As the string vibrates, the capacitance between it and the string varies at an audio rate and there is output across the resistor. In an amplified reed organ the pickup screw is placed close to a selected portion of the vibrating reed as in Fig. 4-b.

FM organs

Electrostatic systems have the disadvantage that high voltages are used on more or less exposed parts of the mechanism, with consequent danger of shock. The high voltage is desirable even though a lower voltage will work because of a second disadvantage, the systems susceptibility to hum pickup due to the high impedances involved. Higher voltage means higher signal-to-noise ratio.

The fact that electrostatic pickup depends on variations in capacitance immediately suggests another approach which eliminates the high voltage and can greatly reduce hum—using the variable capacitance to vary the frequency of an oscillator and produce frequency modulation.

Practical circuits for the purpose will quickly suggest themselves, especially for electric pianos and reed organs which need no electrical keying circuits. An article describing an FM reed organ and explaining the design methods can be found on page 32 of the October, 1948, issue of RADIO-ELECTRONICS.

Record reproductions

One of the grandest ideas in scope ever kept in mind by the writer—and undoubtedly by many readers—is to make an instrument with a series of sound recordings as tone sources. If we could make a record of several ordinary acoustic instruments, each record containing a single pitch played on a single instrument, then have all the records playing continuously, we could select the output of any record with playing keys and produce a precise replica of the sounds of each instrument.

Fascinating as the idea is, it is very difficult to make practical, although one fairly well-known kind of organ—the photoelectric—does, in a sense, use recordings. Obviously the idea is totally impractical with phonograph records, if for no other reason than that no record has yet been invented in which a single groove could be played over and over again without soon getting unusually worn. It is fairly practical with magnetic records, though the required equipment would probably be voluminous and expensive.

One inventor, Graydon F. Illsey, of Omaha, Nebraska, has worked on the idea in patent No. 2,533,961, using magnetic wire. In bare outline, he has a series of discs, each with a length of recorded wire mounted in a shallow groove around its edge. If the organ has five octaves, there are 61 discs for each instrument to be reproduced, and each disc has a recording of one tone. If there are 10 instruments to be reproduced, 610 discs are necessary—each with its own magnetic playback head. While there is no reason why the idea

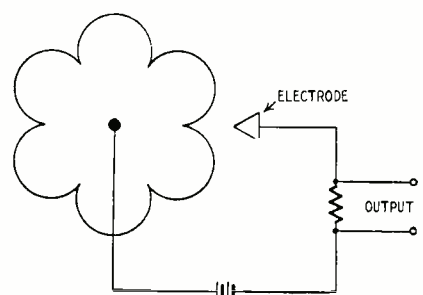

Fig. 3—Another way of varying capacitance. The shirred disc and the pointed pickup are the plates; distance between them is varied as the disc is rotated.

would not work, it would probably not be cheap to produce!

The same problem rears its head here as with other rotating-disc ideas—the fact that the waveforms must be re-entrant. That is, the joined ends of the circular recording must have waveforms in phase. To put it another way, each record must contain an integral number of waveforms. The problem is not difficult with photoelectric and electrostatic

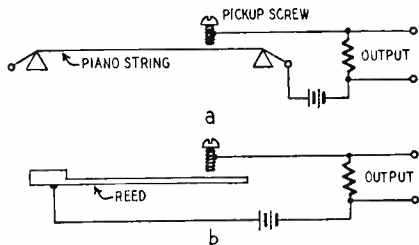

Fig. 4—Electrostatic pickup arrangements for amplified pianos *a* and reeds *b*.

discs, for they are usually provided with the necessary patterns by an artist or draftsman when the original models and the production dies are made. In any case the waveforms are visible.

In magnetic records the waveforms cannot be seen, so another method is necessary. John Hays Hammond, Jr., has given an excellent answer in his Patent No. 2,475,742. Fig. 5 shows how it works.

The note to be recorded is played into the microphone, amplified, mixed with supersonic bias, and sent to the recording head. The disc on which the endless recording is to be made is driven by a synchronous motor (through a mechani-

probably be placed so that signals could be erased after unsuccessful tries.) Naturally, the speed of the disc and the frequency of the signal have been calculated in advance.

Any incorrectness manifests itself as a single point on the disc where the phase of the monitored signal suddenly jumps—that is, the reproduced wave, if sine, might suddenly for one cycle take on an appearance like that shown in Fig. 6, and a portion of a cycle is skipped. In that case the signal contains a large component of a frequency equal to the rotational speed of the disc.

The invention has a way to check that. When the switch S1 is closed, the monitored signal is sent through a filter which selects one harmonic of the recorded sound (actually, of course, it is not a sine wave) and suppresses all others. This is followed by an amplifier and a tuned detector similar to that in any broadcast receiver. The frequency of the sound is, naturally, much higher than that caused by the rotational speed, so the selected harmonic is modulated by the once-per-revolution frequency. The detector demodulates the harmonic frequency, leaving only the rotation-frequency component, if any, and passes the latter on to an indicator. The finished record can then be judged by the indicator reading, optimum condition being no reading at all.

As the finishing touch to our discussion of tone generators, we shall give complete details next month about the Strobocoan, an electronic instrument used for tuning organs (both electronic and acoustic), pianos, and most other

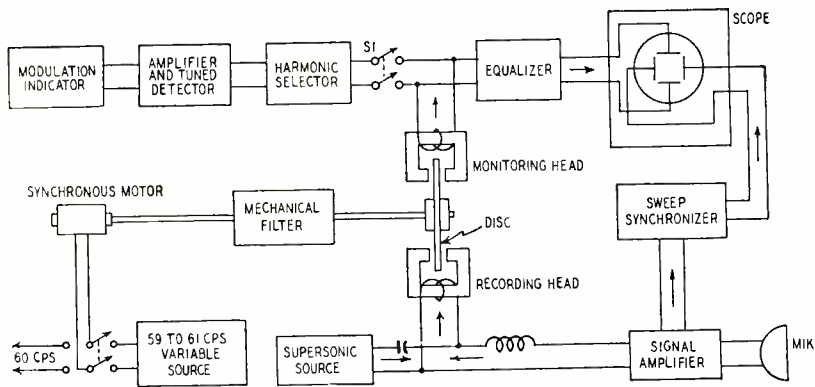

Fig. 5—Block diagram of a patented method of making reentrant magnetic recordings. The disc speed is varied to get an integral number of waveforms.

cal filter to remove transient speed variations) which may be powered either by the 60-cycle line or by a variable 59-61-cycle source.

At the other edge of the disc is a monitor head which picks up the recording just made and sends it through the necessary equalizer to one pair of plates of an oscilloscope. The other pair of plates is fed a sweep signal triggered by the same amplifier.

The waveform on the scope quickly shows whether the track is re-entrant. If not, the operator simply adjusts the speed of the motor by switching the motor to the variable-frequency power source until it is. (Although Hammond does not mention it, an erase head would

instruments, and which can also indicate roughly the harmonic structure of the notes of various instruments. It is portable, yet its accuracy is much less than the hundredth part of a semitone!

(continued next month)

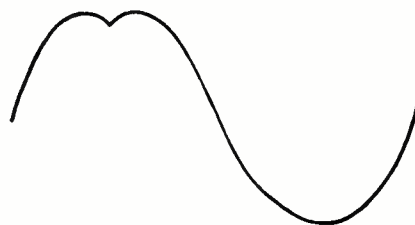
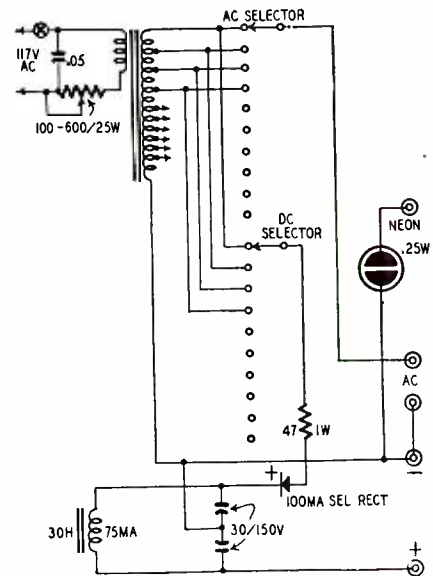

Fig. 6—A sine-wave signal on a non-reentrant endless record might look like this at one point on the record's output.

EXPERIMENTER'S POWER SUPPLY

The transformer from an old tube tester can be used to make a useful power supply for experimental work. With the transformer that I have, the supply delivers 1.5, 2.5, 5, 6, 12, 25, 35, 50, 70, and 120 volts a.c. and d.c. Any two a.c. and d.c. voltages can be selected and used simultaneously as long as the current drain does not exceed the rating of the transformer.



If the transformer you select has more or less than 10 taps, the selector switches can be changed accordingly. A 100-600-ohm, 25-watt potentiometer can be inserted in series with the primary winding to vary the output voltage between the taps.

A ¼-watt neon lamp is inserted in series between the common terminal on the transformer and a pin jack on the panel. This is used to check paper capacitors and large micas for shorts and open circuits. The usefulness of the supply can be increased by adding another switch in the a.c. circuit, and a switch, rectifier, and filters to the d.c. circuit. These will make it possible for the supply to deliver four different voltages simultaneously.

A variable supply such as this is inexpensive to build and has many uses. Surplus transformers, for example, often lack markings to indicate what windings it has. These are easily found by first checking continuity of the various leads, then applying a low a.c. voltage to any pair which show a low resistance. If the voltmeter does not read, the a.c. voltage can be increased until it does. This avoids the danger of applying a high voltage to a low-voltage winding.

A variable d.c. supply is also useful for determining the optimum operating conditions for a circuit. Once the circuit is hooked up, the voltages can be varied until the best conditions are found. The permanent power supply for the circuit can then be designed to provide this voltage.—Frank A. Graulich

Rico Amplifier

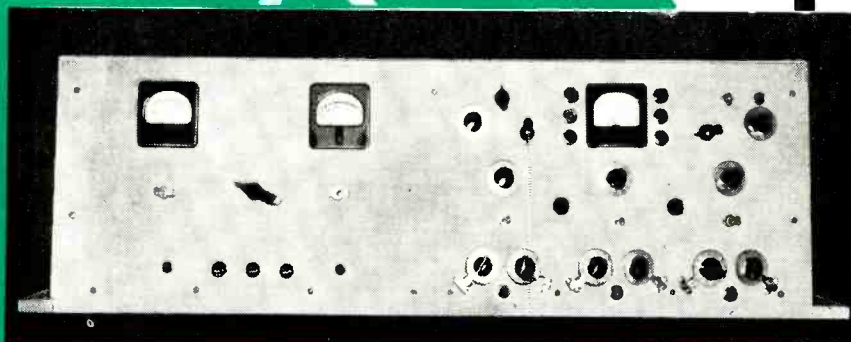

Front panel of the amplifier. Behind the left half is the power supply; the amplifier chassis is behind the right.

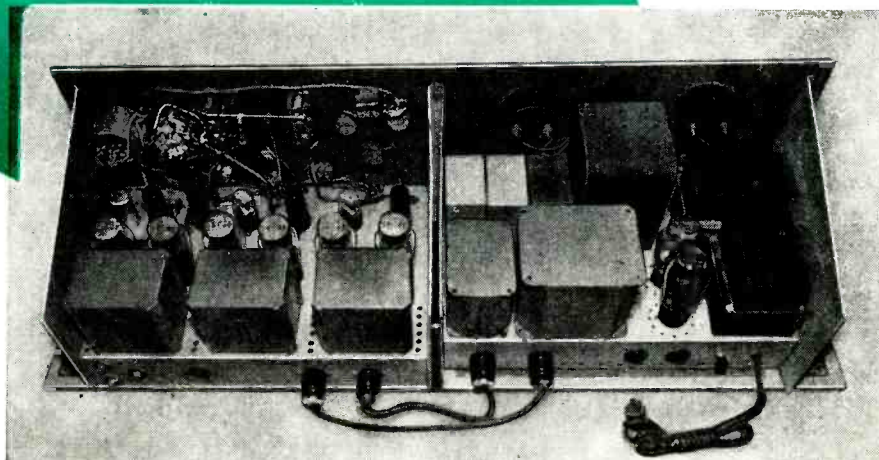

A top view of the amplifier shows its two chassis and general parts layout.

A new approach to realism in audio from Puerto Rico

By JACINTO SUGRAÑES

THE intense search by audio men to find a way to get realism into sound reproduction has led along many paths. One trend has been toward the use of multichannel amplifiers, in which each channel has control over a different part of the audio spectrum.

This system is such an amplifier. It is a 3-channel, all-triode circuit with each channel ending in a pair of 2A3's in push-pull. Each channel has its own roll-off frequency control, compensated phase inverter adjustment, individual power-tube bias adjustment, and volume control.

The three channels are fed by a pre-amplifier which also has a volume control as well as a variable equalizer for different types of records. Another pre-amplifier is used to boost the output of a variable-reluctance pickup. The power supply has a built-in line-voltage selector.

The question is, are all these controls necessary? "Yes!" is the answer. This is because there is little standardization in recordings and in loudspeaker and

pickup performance, and also because of the differences in room acoustics and personal tastes.

Usually the weakest link in a high-quality audio amplifier is in the speaker system. Even the costliest loudspeakers are far from ideal. It has so far been impossible to build a single cone loudspeaker that has a uniform frequency response over the full audio range. The impedance of a loudspeaker varies as the frequency applied to it is varied. Usually speaker impedances are given only for 400 cycles.

The greatest advantage of using three channels in an amplifier is that it is no longer necessary to use high-priced speakers. By dividing the amplifier output into three frequency ranges and using different speakers for each range, each speaker can be matched for best results over a relatively narrow band. This assures optimum speaker performance over the entire audio range.

In this amplifier the medium frequency channel is matched to the 400 to 1,000-cycle range, which is the same as that of most monochannel systems. The

treble channel is matched to about four to five times the 400-cycle impedance because the impedance increases with frequency. The bass channel is matched to the bass speaker at somewhat below 400 cycles to avoid the resonant peaks which are so common. This system permits matching at the most favorable conditions in three acoustic regions, providing what is perhaps the most important feature of this amplifier.

Obviously the correct taps to use on the output transformer will depend on the particular speakers used. The best way to determine this is to actually measure the impedance of each speaker over the range it must cover, and choose the taps accordingly.

The schematic of the amplifier is shown in Fig. 1. Each of the three channels is similar both in design and construction to the others, except for slight variations in the values of some of the components. Besides the 2A3 push-pull output stage, each channel has one 6N7 double triode which acts as a voltage amplifier and phase inverter, and one 12AH7 resistance-coupled amplifier.

The voltage outputs at the two plates of the 6N7's must be 180° out of phase to feed the 2A3 grids. The phase inversion is obtained by tapping a voltage-divider circuit connected in the plate of the first half of the 6N7. All three channels are similar in this respect. Potentiometer R6, in series with R5 and R7 and shunted by C8, acts as a tone equalizer for the phase-inverted voltage. Adjusting R6 balances the signal voltage on the grids of the two output tubes. Once the adjustment is made, the potentiometer is locked. The volume control for each channel is in the grid circuit of the first half of each 6N7 tube.

The input circuit

A 12AH7 voltage-amplifier stage precedes each of the 6N7 phase inverters. Each of these stages has a 100,000-ohm resistor in both the plate and cathode circuit to make up the total load of the tube. The resistance in the cathode gives the stage a large degree of negative current feedback. Further negative feedback is obtained through a plate-cathode network consisting of R3, R4, C5 and C6 in the treble channel and similar networks in the other two chan-

nels. In the treble and bass channels these serve also as frequency-discriminating circuits by the addition of C7 and C9. With R3 and R8 made variable, the low frequency turnover and the high-frequency roll-off may be preset at will. The diagram shows another feedback loop to the grid of this stage from the secondary of the output transformer. A 100,000-ohm resistor is indicated in this loop, but the actual value will depend on the impedance of the speakers used, and a little cut-and-try may be necessary.

The leftover half of the 12AH7 voltage amplifiers is used as a common stage to feed all three channels. The plate and cathode resistors of this stage have a relatively low value and the cathode is heavily bypassed. The output of this stage may contain voltages of higher than audio frequencies, and these must be filtered out. The choke-capacitor filter L1-C4 serves this purpose. L1 should not be less than about 80 mh and the capacitor should be about .001 μf.

The input circuit to this common amplifier stage has the over-all volume control R1 as well as a record equalizer made up of R2, C1, C2, and C3. A loud-

ness control is used in series with the 2-megohm volume control R1. This is nothing more than a compensated control which keeps the balance between highs and lows regardless of volume level. R1 is then used to preset the volume level so that the amplifier will not be overdriven on loud signals. To design and construct a compensated control is rather tedious and we use a commercial product (Livingston) which has a good characteristic for this purpose. However, this control is a refinement that can be omitted, if not desired.

The magnetic pickup we use is a Pickering which is coupled to its pre-amplifier through an input transformer. The two primary coils of the transformer (in this case, a Shure microphone cable transformer model A86A) are connected in series. If these coils are connected in parallel, the low tones are too predominant. The secondary feeds directly to the grid of the G-E preamplifier, which is slightly modified to suit the pickup-transformer combination. These changes consist of simply removing the resistance-capacitance network in the input circuit of the amplifier, and establishing a feedback loop between the two plates of the 12SC7

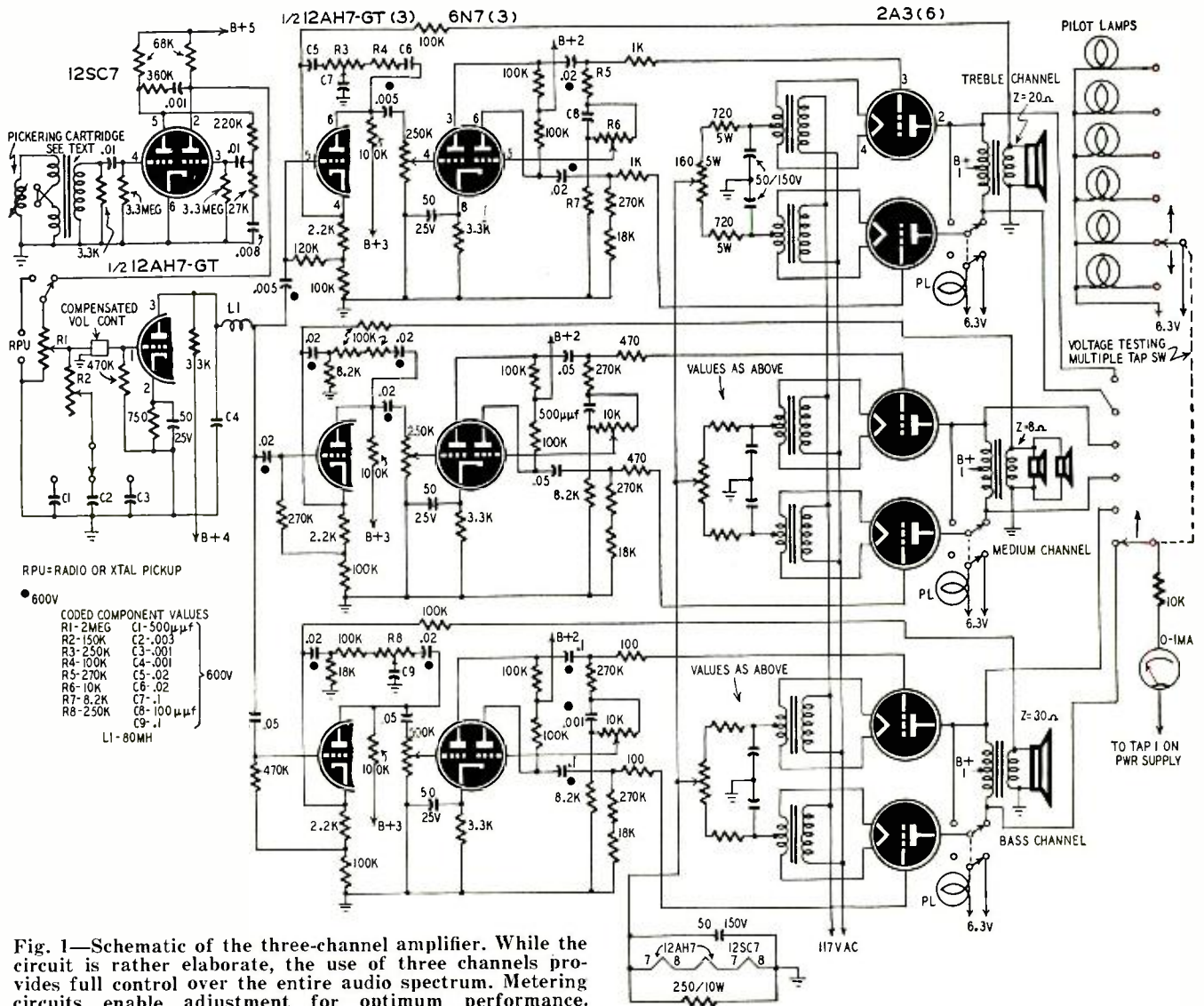

Fig. 1—Schematic of the three-channel amplifier. While the circuit is rather elaborate, the use of three channels provides full control over the entire audio spectrum. Metering circuits enable adjustment for optimum performance.

with the 360,000-ohm, .001- μ f combination.

Because 2A3's in push-pull must be carefully balanced for best results, the circuit is designed so that the bias is adjustable on each pair of output tubes and the plate voltages are metered for making the adjustment. The meter is connected to measure the d.c. voltage drop across both halves of each of the three output transformers. (This method assumes that the two halves of the output transformer primary have equal d.c. resistance. This is usually the case only with the more expensive types of output transformers. Measuring the plate current is more accurate because changes in the voltage drop will be small even for fairly large changes in plate current.—*Editor*)

The heater supply for the two 12AH7's and the 12SC7 is direct current. The heaters of these tubes are put in series and form part of the self-bias resistance for the 2A3's. By this simple expedient, one circuit does two jobs. Direct current for the heater is important in these early stages to keep hum at a low level.

Power supplies

The power supply for the amplifier is built on a separate chassis, as indicated by the photos. The two chassis for the amplifier and power supply are each 11 x 17 x 3 inches. These are mounted side by side on a steel frame and a single $\frac{1}{8}$ -inch metal panel, 12 x 37 inches, holds the meters, pilot lamps, and all controls.

The normal plate-current drain of the

amplifier is about 250 ma, so the power transformer should be capable of supplying at least this current with a little to spare. We had no such transformer available when building the supply, and used two 200-ma transformers in the hookup shown in Fig. 2. The rectifier filaments are in series with each other and with the 5-volt windings of the power transformer. This protects the power transformers in case one of the rectifier tubes should burn out. The 5-volt heater windings must be phased correctly when the circuit is wired up.

The rectified current is fed through a series of filter sections, and voltages are tapped off from these sections for appropriate stages of the amplifier. The plate-current load of the amplifier is metered with a 500-ma d.c. instrument, and the meter is protected by a $\frac{1}{2}$ -amp fuse. The input circuit to the power transformers includes a 350-watt line-voltage selector of the autotransformer type which permits variations from 80 to 150 volts a.c. This can be omitted if the line voltage variations are not large enough to affect the amplifier's operation. The a.c. input voltage is also metered, and two fuses protect the transformers.

The layout

The front panel photo shows the layout of meters, switches, and controls. The power supply is behind the left side of the panel. The a.c. voltmeter and the plate-load-current meter are at the top of this half of the panel. Three fuses and two pilot lights are in a row at the bottom, and halfway up are the ON-OFF

switch and the line-voltage selector switch.

The bottom row of controls on the amplifier side of the panel includes the phase-inverter-control and the bias-control potentiometers for each of the three channels. These six controls are all supplied with locking devices. Below these controls, at the very bottom of the panel, are three pilot lights. The one at left (green) indicates when the treble channel is on; the middle (amber) represents the medium channel; the one at right (red) is the bass channel lamp.

The three toggle switches in a row directly above the row of phase-inverter and bias controls are d.p.d.t. switches used to connect the plates of the output tubes in parallel for balancing and for switching in the pilot lamp of each channel. The two small knobs directly above the toggle switches are on the roll-off frequency setter in the treble channel (at left) and the bass turnover control.

The row of three controls just below the meter are the volume controls for the three channels. The meter on this half of the panel is the 1-ma unit used to check the voltage drop across the transformer windings. The three controls to the left of this meter, which are arranged in a triangle, are (from left to right) the general volume control, the record equalizer selector switch, and the record equalizer adjuster. To the right of the meter is its selector switch, the radio-phono selector toggle switch, and the compensated gain control. The three pilot lights on each side of the meter light up to show which output plate circuit is being metered. The meter selector switch also chooses the appropriate light.

The top chassis photo indicates the general layout of the amplifier. The power-supply layout is not at all critical and will depend largely on the size and shape of the transformers and chokes. The amplifier chassis layout is simplified by the fact that the three channels are nearly identical. Here it is important to use short leads and to shield the low-level signal carrying leads.

In the second part of this article we shall discuss the operation of this deluxe amplifier and how to adjust it to get the most from it.

Materials for amplifier

Resistors: 2—100, 1—750, 2—1,000, 2—2,200, 4—3,300, 4—8,200, 4—18,000, 1—33,000, 2—68,000, 20—100,000, 1—120,000, 1—150,000, 7—270,000, 1—360,000, 2—470,000 ohms, 2—3.3 megohms, $\frac{1}{2}$ watt; 1—27,000, 1—33,000, 1—220,000 ohms, 1 watt; 6—720, 1—30 ohms, 5 watts; 1—20,000 ohms, 20 watts; 3—10,000, 4—250,000, 1—500,000 ohms, 1—2 megohms, potentiometers; 3—160 ohms, 5 watts, potentiometers.

Capacitors: 1—.0001, 1—.0005, 4—.001, 2—.003, 2—.005, 10—.02, 4—.05, 1—0.1 μ f, 600 volts, paper; 4—50 μ f, 25 volts, 7—50 μ f, 150 volts, 6—8 μ f, 600 volts, electrolytic.

Inductors: 2—800 volts, c.t. power transformers with 5-volt and 6.3-volt windings; 6—2.5 volts, filament transformers; 1—15 h, 500 ma, 1—15 h, 120 ma, chokes; 1—80 mh, choke; 1—microphone transformer (Shure A-66-A or equivalent); 3—audio output transformers, push-pull 2A3's to voice coil; 1—line-voltage selector (optional).

Miscellaneous: 1—12SC7, 2—12AH7-GT, 3—6N7, 6—2A3, 2—5U4-G, tubes and sockets; 11—pilot lamps and assemblies; 1—1 ma, 1—500 ma, d.c. meters; 1—150-volt a.c. meter; 2—5-amp, 1—1-amp fuses and holders; 3—d.p.d.t., 3—s.p.s.t., 1—6 position, 2-gang switches; chassis, hookup wire, assorted hardware.

(concluded next month)

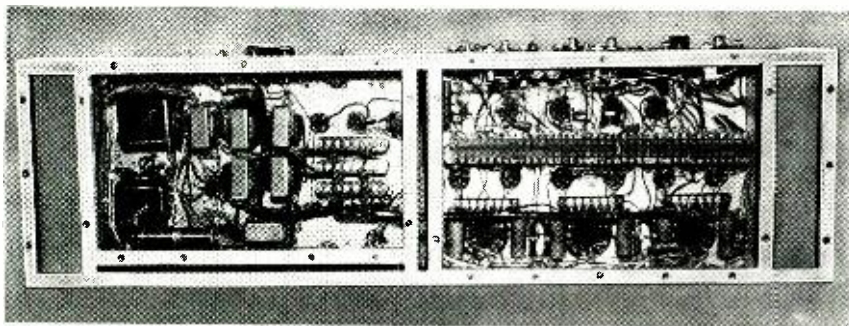

The wiring under the chassis is neat. The amplifier chassis has only three ground points, one for each channel. Terminal boards simplify the wiring.

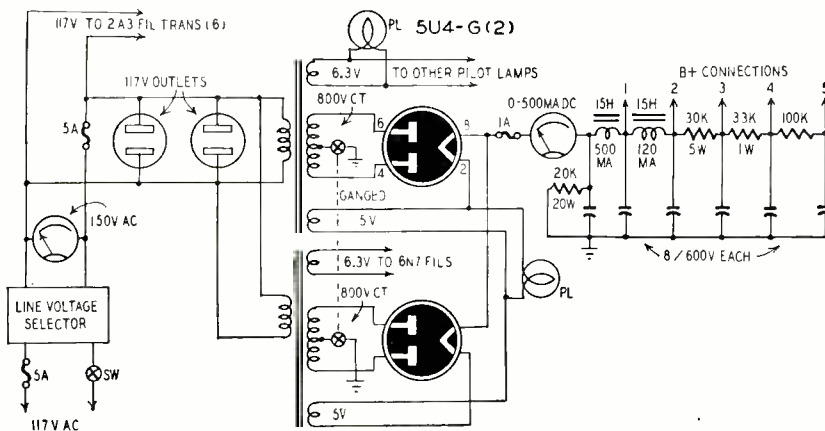

Fig. 2—Circuit of the power supply of the amplifier. One transformer may be used to replace the two shown if its current rating is sufficiently high.

Audio Feedback Design

By

GEORGE FLETCHER COOPER

Part VIII—Negative feedback as a regulator of both output and input impedance of an amplifier circuit

IN THE earlier articles of this series we have seen how the use of negative feedback makes the properties of an amplifier depend more on the behavior of a passive network than on the behavior of the amplifier itself. Since the "passive network" is usually just a couple of resistors, with no distortion and no frequency dependence, the overall circuit gives a flat distortion-free response. Very often, though, that in itself is not enough. For most readers, though not for most amplifiers, the probable load is a loudspeaker: If you get the cone vibrating nicely and then cut off the input you have a coil moving in a magnetic field and thus acting as a generator, so that the impedance seen by the coil looking back into the amplifier is important. I confess freely that I have never discovered just what musical instrument can produce the sounds which make this important to the hi-fi boys; but that idea is un-American, not cricket, or like ordering a certain soft drink in a Bordeaux bar.

Right or wrong, output impedance control is usually considered part of the job of a feedback amplifier. In quite a different connection, so is input impedance control. The commonest example of this is in voltmeter and oscilloscope amplifiers, when we wish to avoid loading down the circuit to which the amplifier is connected. Nine times out of ten a cathode follower, which is just a stage with a feedback β of 1, is used.

Before we consider the amplifier as a whole, it is rather instructive to see what happens to a single tube with feedback. For an example which is reasonably typical, I have drawn in Fig. 1 the characteristics of a 6AQ5 tube: a miniature which will give you 3-4 watts. It is a pentode, and at the standard working point, $E_b = E_c = 250$ volts, $E_g = -12.5$ volts, $I_b = 45$ ma, the transconductance is about 4,000 μ mhos and the impedance about 50,000 ohms. This last figure is the real problem: the optimum load is 5,000 ohms, so that if you transform down to use a 15-ohm loudspeaker, the speaker will be looking back at 150 ohms. It might as well be an open circuit, as far as damping down speaker resonances goes.

Let us see what happens to the tube characteristics if we apply negative feedback. To make the calculations easy, let us apply feedback of $1/10$ of

the plate voltage to the grid. Starting at the point $E_c = 10$, $E_b = 300$, let us reduce E_c to -5 volts; then if E_b drops by 50 volts we shall feed back $+5$ volts to the grid, and we shall be on the same E_c line as the starting point. Similarly, the point $E_c = -10$, $E_b = 300-100$ is on this $E_c = 0$ line.

The resulting characteristic is drawn in Fig. 1: I've drawn the feedback tube curves as broken lines. Forget that I said we had a pentode and you will see that the new characteristics are those of a triode, with an impedance of 2,100 ohms at the original working point. If you connect this plate-grid feedback around a pentode and put it in a black box, anyone measuring the characteristics will think they have a triode. There is only one difference: you can swing this triode down to a plate voltage of 50 without running into grid current; the corresponding limit when the screen and plate are joined together is about 170 volts.

The results of Fig. 1 are well worth a closer study. In the area below $E_c = 0$ there is no grid current, because the feedback circuit will be an a.c. coupling. A pentode with negative feedback of this kind has the same characteristics as a triode, including the triode positive grid region, but you can work over the whole set of characteristics without grid current trouble. I stress this because I have just had a letter from a British reader who doesn't believe that tetrodes can sound as good as triodes. Cast your eye over those curves, they are better than triode curves! Maybe we should call the feedback triode *Bit-ter Rice*.

We can, to some extent, reverse this effect. A typical triode characteristic is shown in Fig. 2. This triode has a μ of about 50, and an impedance of about 20,000 ohms. By putting in a cathode resistor of 2,000 ohms we can make a change of 1 ma in the plate current feed back 2 volts to the grid. The effect of this is shown in part by the broken lines on Fig. 2. These are part of the characteristics of a "black box" tube having an impedance of about 105,000 ohms, which is getting on toward the pentode class. If you need a pentode, and only have a triode handy, this is one way of making the circuit think it sees a pentode.

These two examples of modified tube characteristics have been considered

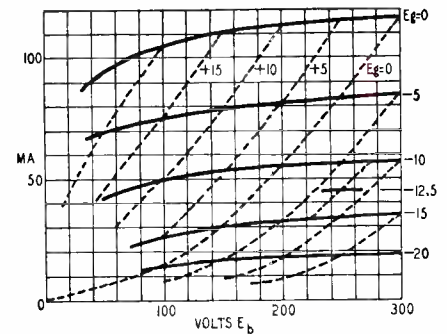

Fig. 1—Negative feedback from plate to grid makes the 6AQ5's characteristic (shown in solid lines) look like those of a triode tube (broken lines).

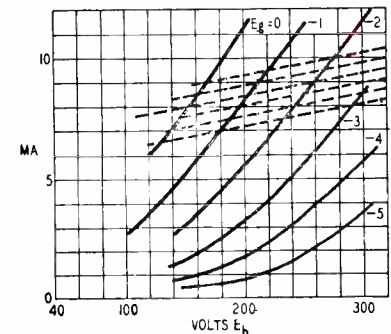

Fig. 2—Negative current feedback will alter the curves of a triode so they will take on the high-impedance characteristic of a pentode (broken line).

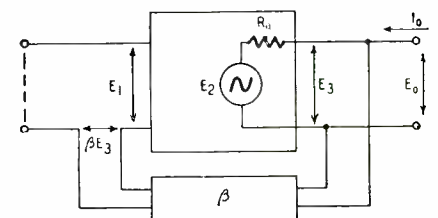

Fig. 3—Voltage feedback network used for calculating output impedance.

because they provide a useful background to the general discussion of amplifier impedances. Ultimately any amplifier can be considered as a 4-terminal network in a box, and if you don't look inside you cannot be certain that it is not just one tube, with a transconductance of 1 amp/volt, perhaps! Now we can turn to the general amplifier circuit. Fig. 3 shows the general voltage

feedback amplifier, with input short-circuited and output connected to a generator. This generator produces a voltage E_o at the output terminals, and the current flowing into the amplifier is I_o . The amplifier itself has an impedance of R_o and an open-circuit gain, E_o/E_i of K_o . Notice that we are using now the open-circuit gain, which will be quite a lot higher than the usual loaded gain. For a triode the difference is 6 db, but for a pentode or tetrode it may be much more. The feedback network β is assumed to be of such high impedance that it does not affect the impedances.

In the output mesh, we have this equation:

$$E_o - E_2 = I_o R_o$$

Now $E_2 = KE_1$, and since the only input is that provided by the feedback network $E_1 = \beta E_3$ or, indeed, $-\beta E_o$ since E_3 and E_o are the same here.

Thus $E_2 = -K_o \beta E_o$ and we can substitute in the previous equation:

$$E_o + K_o \beta E_o = I_o R_o$$

$$\frac{E_o}{I_o} = \frac{R_o}{1 + K_o \beta}$$

Of course E_o/I_o is the impedance seen by the generator connected to the output, and if the feedback were absent, $\beta = 0$, the impedance would be R_o . With negative feedback the impedance is reduced by the factor $(1 + K_o \beta_o)$.

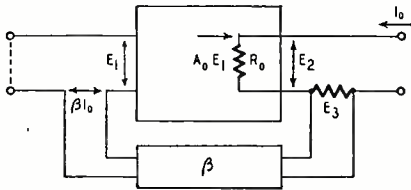

Fig. 4—Network using current feedback.

This feedback was voltage feedback. We could use a circuit like that of Fig. 4, in which the feedback voltage depends on the current in the output circuit. To keep the formulas very simple, the resistance across which the feedback is picked off will be assumed to be small, just as before we assumed that the β network was of infinite impedance. In calculating this circuit we work in terms of current: the amplifier is assumed to have a transconductance of A_o , under short-circuit conditions, so that it produces an output current of $A_o E_1$ for an input of E_1 . When we apply an additional current of I_o , we have a current of $(I_o + A_o E_1)$ through R_o , so that the voltage across the output terminals is:

$$E_2 = (I_o + A_o E_1) R_o$$

The feedback network (including the small resistor across which E_3 is produced) delivers a voltage βI_o to the input terminals, and since the input has no other supply $E_1 = \beta I_o$.

$$\text{Thus } E_2 = (I_o + A_o \beta I_o) R_o$$

The admittance seen at the output is I_o/E_2 and is

$$\frac{1}{R_o} \times \frac{1}{1 + A_o \beta}$$

If there were no feedback ($\beta = 0$) this would be just $1/R_o$. With current

negative feedback, therefore, the output admittance is reduced by the factor $(1 + A_o \beta)$. This means, of course, that the impedance is increased by this factor.

It must be noted that the factor A_o is not the same as the K_o we have discussed, and it is not the same as the factor K in the $(1 + K\beta)$ term we used in the distortion and gain effects in earlier articles. This means that we must make a separate calculation when determining the output impedance. When using voltage feedback we must use the equation

$$M = \frac{\mu R}{R + R_o}$$

for the gain of the last stage in determining the gain factor K , but $M_o = \mu$ for the impedance factor K_o . If, however, the feedback network uses resistors of normal value, we may find it more accurate to write

$$M_o = \frac{\mu R'}{R' + R_o}$$

where R' is the input impedance of the feedback network. We also ought to bring the output transformer losses into R' . Usually this means that K_o is about 3 times the usual value of K .

By using positive feedback, the term $(1 + K_o \beta)$ can be made less than unity. Thus, positive voltage feedback increases the output impedance and positive current feedback reduces the output impedance. We can mix positive voltage feedback and negative current feedback to give a very high impedance, for example, without losing too much gain. I should like to devote a lot more space to this, but it is of rather restricted interest. As examples of what can be done, I may say that I have one small amplifier, using a 12AT7, which has an impedance, at the high side of the output transformer, of something around 5 megohms. This is better than pentode performance. Another amplifier, using pentodes, gives an impedance of 0.1 ohm when designed to work into a 25-ohm load: this uses positive current and negative voltage feedbacks. There are good reasons for these designs: the pentode is needed to get power at low supply voltage, the 12AT7 to get gain from a single bottle, and the extreme impedances are "musts."

The circuits for giving voltage and current feedback are summarized in Fig. 5. F is the feedback voltage in each case, and a, b, c are voltage feedback, d, e, f are current feedback. The table is a summary showing whether the feedback should go to cathode (k) or grid (g) of an earlier stage to be negative or positive. The plus signs show positive feedback, the minus signs negative. Thus in a 3-stage circuit you must feed back from cathode to cathode (circuit d) or from anode to grid (circuit e) to get negative current feedback.

For the sake of completeness I must mention the bridge feedback circuit. In this the feedback does not affect the impedance, but having mentioned it I

should add that I have never seen it used. Tube impedances are not so constant that anyone wants to keep them unaffected.

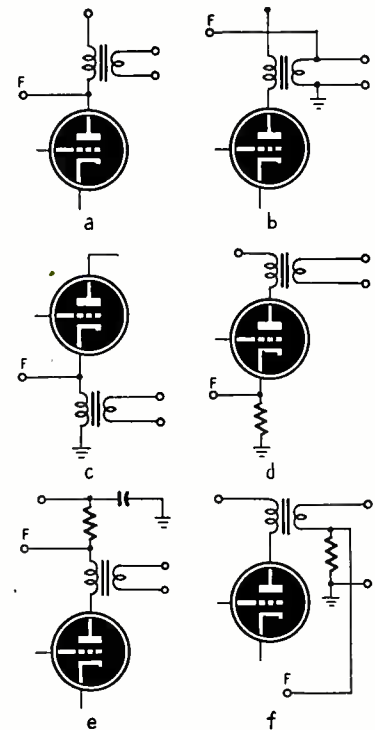

Fig. 5—Skeleton circuits showing six ways to pick off feedback F . The first three, a, b , and c , are voltage feedback; the others are current feedback.

Now let us consider the input impedance. A typical input circuit is shown in Fig. 6, and although I have shown a resistor between grid and cathode, this could be a more complicated impedance. The biasing arrangements are also neglected. In this circuit, the input to the amplifier section K is V_1 , and the voltage developed by the feedback circuit is $V_2 = K\beta V_1$. We must have $E_o = E_1 + E_2 = (1 + K\beta) E_1$, and from this we could deduce that the gain would fall by a factor $(1 + K\beta)$ when feedback was added, because we now need an input of E_o to produce E_1 at the grid.

The current which flows through R is given by

$$I_o = E_o/R = E_o/R(1 + K\beta)$$

So far as any circuit connected to the input can tell, this current is produced by E_o , so that the input impedance is

$$\frac{E_o}{I_o} = R(1 + V\beta)$$

Table for Feedback Connections				
No. of stages	Circuit of Fig. 5			
	a	c	d	e
1	g-			g-
2	k- g+	g- k+	g- k+	k- g+
3	g- k+	k- g+	k- g+	g- k+
4	k- g+	g- k+	g- k+	k- g+

Circuits b and f depend on transformer sense.

The impedance therefore has been increased by a factor $(1 + K\beta)$. This may be 10 to 100, so that a resistance of 1 megohm, which is all we can normally use because of gas current in the tube, looks like 10-100 megohms to the external circuit. The input capacitance is reduced, too, which is important if you are using a crystal pickup. Notice, how-

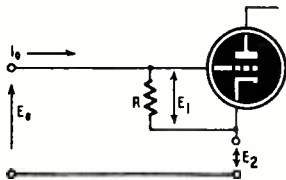

Fig. 6—Amplifier input circuit having series-connected feedback at cathode.

ever, that positive feedback in this connection will reduce the input impedance, since then $(1 + K\beta)$ is less than unity.

An alternate way of connecting the feedback is shown in Fig. 7. The current which flows into this circuit is

$$I_o = \frac{E_o - E_2}{R_1 + R_2}$$

Now

$$E_2 = -K\beta E_1$$

and

$$E_1 = E_o - I_o R_1$$

We therefore have

$$E_2 = -K\beta E_o + K\beta I_o R_1$$

and

$$I_o (R_1 + R_2) = E_o + K\beta E_o - K\beta I_o R_1$$

which we rearrange

$$I_o (R_1 + R_2 + K\beta R_1) = E_o (1 + K\beta)$$

giving

$$\frac{E_o}{I_o} = \frac{R_1 + R_2}{1 + K\beta}$$

The R_1 term is the impedance of the external generator, so that the input impedance, R_2 without feedback, is reduced by the factor $(1 + K\beta)$ with negative feedback. As before, if the feedback is positive this is an increase in input impedance. I have seen no uses

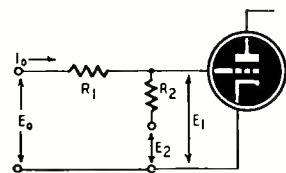

Fig. 7—A parallel hookup for feedback.

for this particular connection described anywhere, but it would seem to be quite possible to apply negative feedback to the cathode and positive to the grid to produce an extraordinarily high input impedance. The negative feedback would stabilize the gain so that the term $(1 - K\beta)$ in the positive feedback equation could be made quite small.

It has been claimed by Griffiths (*Wireless World*, March, 1950) that using Fig. 7 one can get more distortion reduction than loss of gain, mainly as a result of changes in the matching conditions at the input. I have not examined his results carefully, but I do not like using this circuit since the input impedance depends on the value of K .

In many applications it is necessary to provide a controlled value of input impedance, which involves the use of the circuit of Fig. 6 with an additional shunt resistor across the input. Often, too, we need a good 600-ohm output impedance, and then a high impedance shunted by 600 ohms is used.

This has only been a general survey of the problems of impedance control. If an amplifier is needed with some special impedance properties, a closer study may be required, but for almost all jobs the discussion here will be sufficient. Always the effect of feedback is to modify the apparent tube characteristics, and it is probably wise to

point out one important thing. If you turn a tetrode into a triode by means of feedback, the optimum load is unchanged: you should not try to match this "triode." I have checked this statement very carefully, both with modified characteristics and by actual experiment. This is especially important if you are using a high degree of feedback to get a low impedance for damping a loudspeaker, or to get a high impedance for some other purpose. And don't forget, if you want a low impedance, to allow for the resistance of the output transformer windings. This is also important.

(Continued next month)

Audio V.T.V.M. Measures Millivolts

Many audio enthusiasts who construct amplifiers and experiment with a.f. circuits have need for an audio millivoltmeter like the one described here through courtesy of Cornell-Dubilier Electric Corp.

Using a 1-ma d.c. meter, the full-scale ranges of the instrument are .01, 0.1, 1.0, 10 and 100 volts. The response is linear, so the standard 1-ma meter scale is used on all ranges. The 12AX7 is used as two high-gain, resistance-coupled triodes in cascade. The output of the second stage is rectified by four 1N34's in a bridge circuit and fed to the meter at a level of 10 volts r.m.s. for full-scale deflection on all ranges. The power and range switches are on the panel. Calibration controls R1 and R2 have slotted shafts and are mounted on the chassis.

Take the following precautions when wiring the unit: (1) Return all grounds to one point on the chassis. (2) Use shielded leads at points shown on the diagram. (3) Use a shielded, cushioned socket for the 12AX7. (4) The range switch must have ceramic insulation. (5) Twist heater and a.c. power leads into pairs and clamp close to the chassis. Keep them away from the 12AX7 grid leads. (6) Ground the back cover of R1. (7) Use shielded cable and plug on the test prod. (8) All wiring should be point-to-point with solid, insulated hookup wire. (9) Do not leave out the voltage regulator tubes or filter choke to save space or cut cost. Without regulation, the accuracy of the meter varies with line voltage. When a resistor is substituted for the choke, the meter is unstable when the signal voltage is near the fundamental, harmonic, or subharmonic of the line frequency. (10) Mount the unit in a metal case.

To adjust the instrument, break the B-plus line at A, insert a 50- or 100-ma meter in series with the plate of the top 0A2 and the slider on the 2,500-ohm resistor. Set the slider for exactly 30 ma through the meter. Remove the meter and re-connect the B-plus lead.

Set the range switch to 100 volts. Adjust R1 to approximately one-half scale and R2 to one-quarter scale. Do not plug in the probe.

Let the unit warm up for about 5

minutes. Turn the range switch through its ranges and watch the meter for any steady deflection which is an indication of oscillation, noise, or hum. If there is a steady deflection, replace the meter with headphones and identify the signal. If it is hum, ground the center terminal of the input jack. If the hum disappears, it is caused by a strong a.c. field near the unit. If it does not, it may be caused by failure to ground one heater lead, faulty shielding, excessive lead length between the range switch and the input grid, or by mounting the power supply too near the 12AX7.

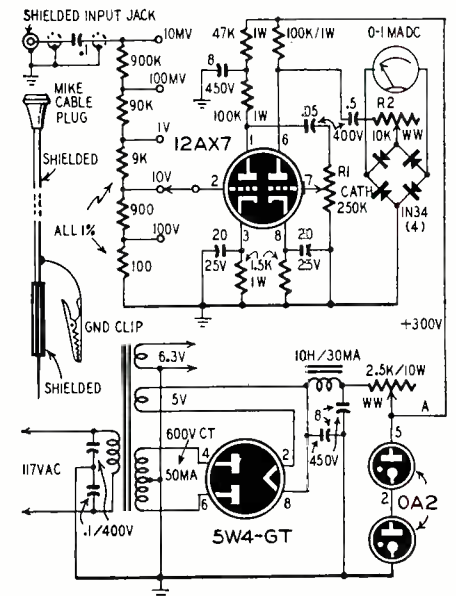

Continuous crackling, hissing, or noise is probably caused by defective tubes, resistors, or capacitors.

To calibrate, set the range switch to 100 volts, R1 to half scale, and R2 to maximum resistance. Plug in the test lead and connect it to an accurate 10-volt a.c. source. A 60-cycle source will do, but 1,000 cycles will provide better accuracy. Throw the switch to 10 volts and adjust R2 so the meter reads exactly full scale. Vary the input from 0 to 10 in 1-volt steps. If the readings cramp at higher voltages, the second triode is overloading. Decrease the setting of R1.

—end—

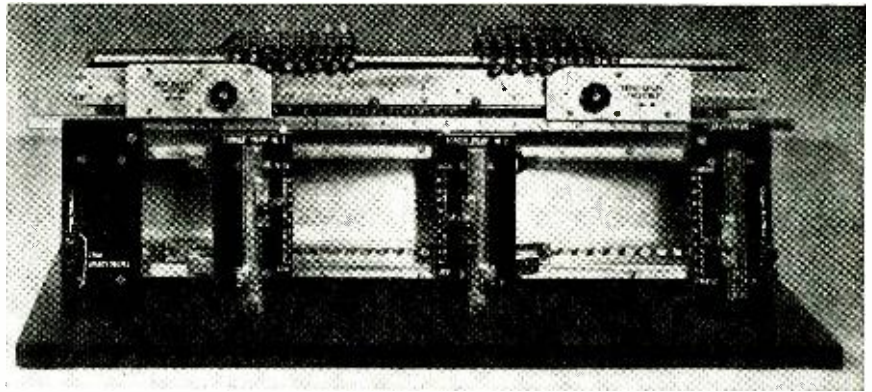

A closeup photo of the equipment. The tongue hump and lip opening sliders are in front, and the contacts for the sliding cavity shorteners project on top.

ELECTRIC VOICE

This electrical analog of the human vocal apparatus produces good vowel sounds

By ERIC LESLIE

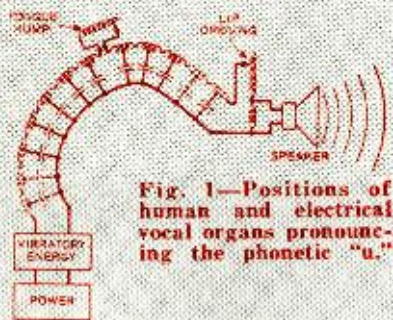
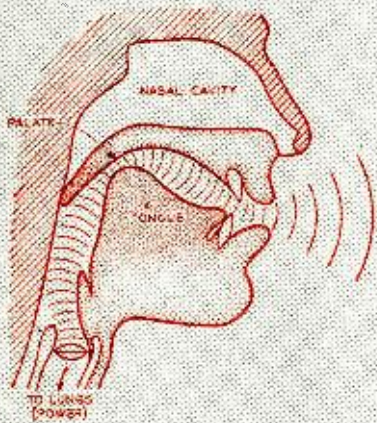

Fig. 1—Positions of human and electrical vocal organs pronouncing the phonetic "u."

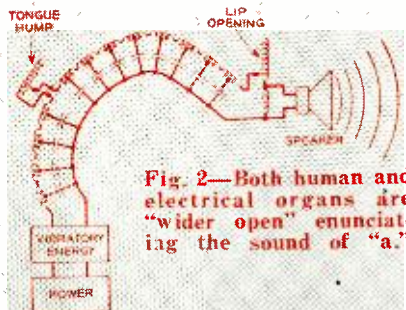
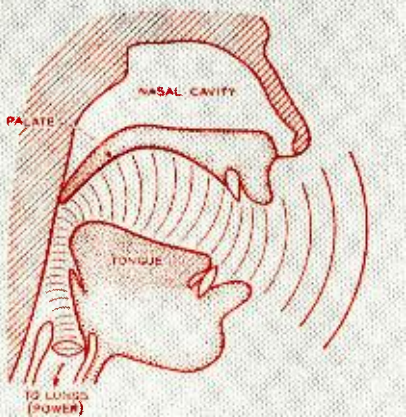

Fig. 2—Both human and electrical organs are "wider open" enunciating the sound of "a."

WE ALL used analogies when we learned radio. Current flow was illustrated by water flowing through a pipe. With

a reciprocating pump added, alternating current was illustrated. Radio waves were (all too simply) represented by a stone thrown into water. Tesla even devised an "oscillator" with a weight for inductance and a spring for capacitance, with steam (from the building's heating circuit) as the source of power. So successful was the analogy that it not only oscillated furiously at a frequency set by the spring tension and the weight, but could also be "loaded," furnishing power for small workbench appliances. So we went through electricity and radio, getting acquainted with each new phenomenon with the help of familiar mechanical analogies.

As we learned more about electronics some of these phenomena turned out to be far more simple than the analogies used to explain them. It was by no means surprising that the analogies should reverse, and that engineers should study the action of a vibrating weight at the end of a spring with the help of an electrical circuit analogy. Radio engineers found it worthwhile to break down the mass, compliance, and friction of a loudspeaker into inductance, capacitance, and resistance, when

studying the action of the cone. Books have been written devoted to describing mechanical actions in terms of electrical circuits.

The reason that such analogies are possible is that we can describe the behavior of both electrical and mechanical circuits with mathematical equations that look exactly alike. Thus in one equation the symbol for voltage may take the place of the symbol for force in the other; inductance is analogous to mass, etc. The same applies also to the equations of thermodynamics, acoustics, and other systems so that a circuit in one of these systems can have an analogy in any of the others. Engineers make frequent use of this fact.

The electric voice equipment shown on our cover is a recent and daring example of the analog-in-reverse. It was designed and constructed by H. K. Dunn and L. O. Schott of the Bell Telephone Laboratories, an organization which makes study of the human voice and human speech one of its chief activities. Since the human vocal apparatus can be represented with an electrical analog, they decided to set up one and feed it from oscillators which produce signals electrically equivalent in frequency and composition to those produced by the vocal cords. Then if its output were turned into sound by a loudspeaker,

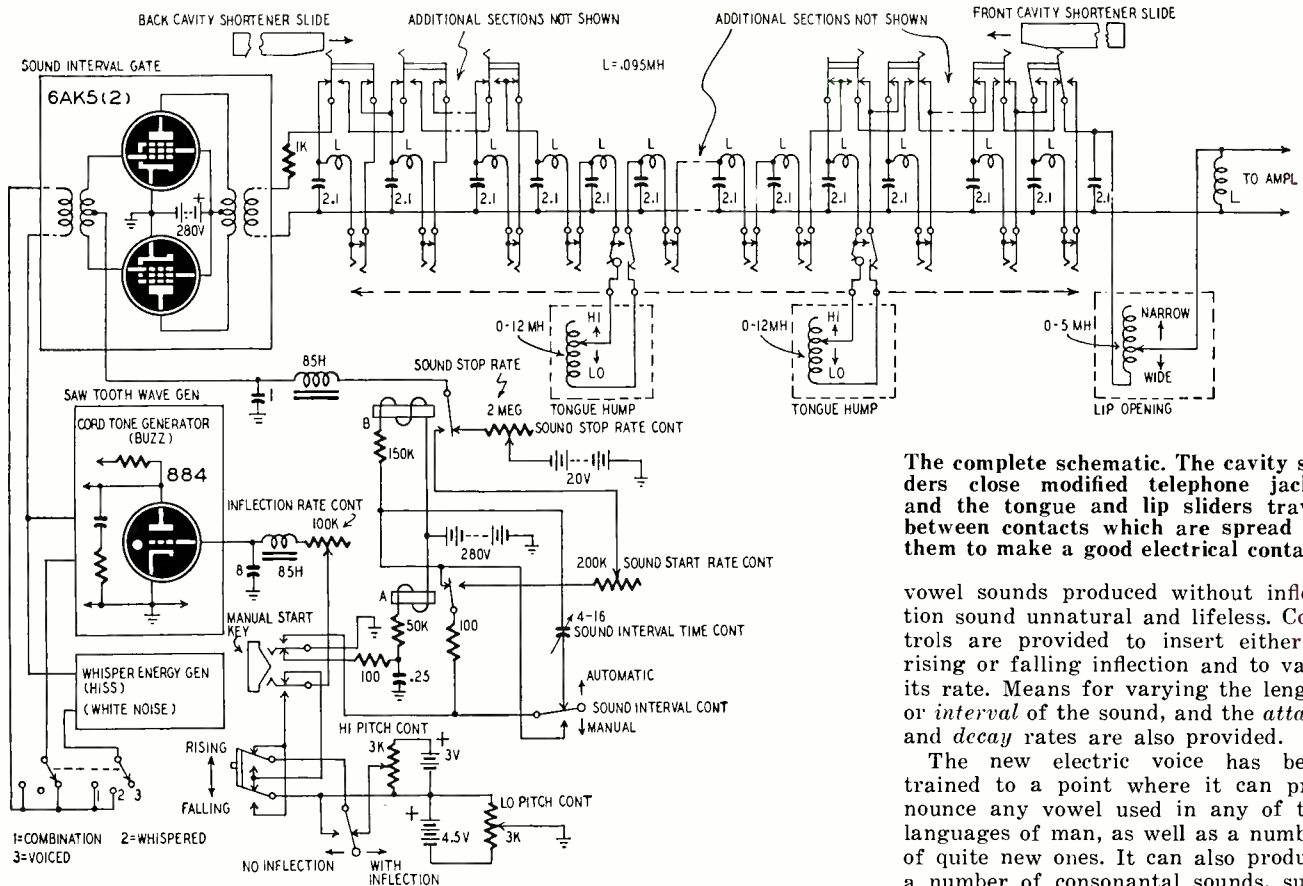

The complete schematic. The cavity sliders close modified telephone jacks, and the tongue and lip sliders travel between contacts which are spread by them to make a good electrical contact.

vowel sounds produced without inflection sound unnatural and lifeless. Controls are provided to insert either a rising or falling inflection and to vary its rate. Means for varying the length or interval of the sound, and the attack and decay rates are also provided.

The new electric voice has been trained to a point where it can pronounce any vowel used in any of the languages of man, as well as a number of quite new ones. It can also produce a number of consonantal sounds, such as the fricatives *f* and *v*, *s* and *z*, and the sounds of *l* and *r*, though some of these require certain additional apparatus not shown in the schematic. Work has been in progress to make it possible to pronounce more of the consonants, but has had to give way, for the moment at least, to projects considered more vital to the national interest. So the time when we will have an artificial voice which can recite "Mary's Little Lamb" is still far in the future. Meanwhile the equipment is a valuable device for studying human speech sounds and their formation in detail.

—end—

GUIDED MISSILE RECORDER

Magnetic recorders using a metal tape 6 inches wide and 150 feet long will be placed in the noses of guided missiles to record data that ordinarily is automatically sent out by radio. As the rockets penetrate the atmosphere above the earth, there is often difficulty with reception of the automatically transmitted signals. The magnetic recorder, announced recently, is manufactured by United Aircraft for the Navy's Bureau of Ordnance. Weighing only 46 pounds, the machine can record 200 pieces of information simultaneously and continuously. The tape is led into an armored cylinder that withstands the shock of dashing into the ground. The tape, played back through a transcriber, enables personnel to make graphs of air pressures, temperatures, and so on. The device was developed by the Armour Research Foundation.

sounds similar to those of the human voice should be produced.

Several attempts to synthesize speech sounds have been made (see "Manufactured Speech," RADIO-CRAFT, August, 1939, for a description of the voder, or vocoder). Voice sounds were analyzed into their frequency components with a series of bandpass filters, like those shown in the illustration of visible speech equipment on page 235, RADIO-CRAFT, January, 1946. Then the frequencies which appear in a given sound were picked out—usually from a bank of tone generators—and mixed in the correct proportions to produce the sound.

That method dealt with the disembodied sounds, without reference to the mechanism which produced them originally. Dunn and Schott started out with the opposite approach, to produce an electrical analog of just that speech-producing mechanism.

The human vocal apparatus, consisting of the throat, tongue, and lips, can be represented by a cylindrical cavity about a square inch in cross-section and about five inches in length. The area and length of this cavity can be varied to some extent by the speaker's throat muscles. Its size and shape is still further modified by the back and tip of the tongue, and by the lips, any or all of which may be moved to pronounce a given sound.

The most exact analog of the human vocal apparatus would be a section of transmission line, with inductance and capacitance distributed along its length. A section of waveguide might be even

more exact. But at voice frequencies such models would be too big to construct, so lumped constants (coils and capacitors) are used.

The vocal cavity is represented electrically by 24 sections of transmission line. The end sections of these are shown in the schematic. Sections can be cut off or added at either front or rear (or both) of the electrical cavity, varying the timbre from that of a baby to the voice of a bass singer.

Two variable inductors serve as the tongue hump (back of tongue) and tongue tip. The tongue hump divides the cavity into two parts, as the real tongue hump tends to do in speech. A similar inductor acts as the lip opening. High inductance in these circuits is equivalent to constricted throat passages and narrow lip opening; lower inductance represents wider vocal passages and a more open mouth. Fig. 1 is a representation of the human and electrical vocal tract while pronouncing the phonetic "u" (as in "rule"). Fig. 2 is the position while pronouncing the vowel "ah." (The drawings were made before the forward tongue hump had been added to the circuit.)

The "larynx" and control circuits appear at the left end of the schematic. A sawtooth oscillator and "white-noise" generator provide, respectively, the electrical equivalents of voiced and unvoiced sounds from the vocal cords. An important part of the circuit is the inflection control. The human voice does not maintain exact pitch while pronouncing even short vowel sounds, and

U. H. F. is The Keynote of Annual I. R. E. Show

RADIO engineers look to the annual I.R.E. conventions and exhibitions for a key to the future of electronic development. This year's meeting indicated plainly that the immediate future of electronics is in the higher frequencies. Equipment and discussions aimed at u.h.f. television broadcasting and at other commercial and military uses in the ultra-high signals trend unmistakably.

One of the first signposts pointing toward the ultra-highs was the ceramic triode announced by General Electric, illustrated in Photo A. This tube, only

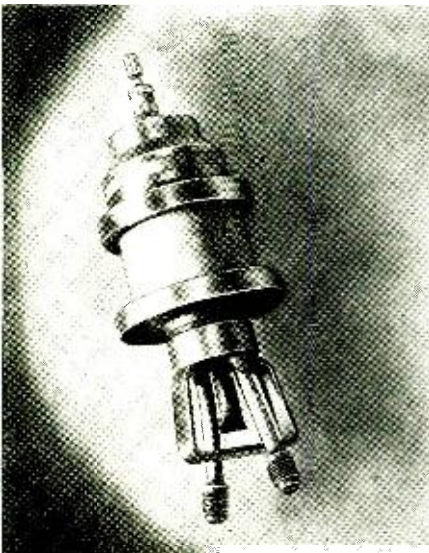

Photo A—The new ceramic tube by G-E which has an output of 1 kw at 900 mc.

8 inches long, will operate at 1 kilowatt output up to 900 mc. It is designed to be used, like the lighthouse type receiving tubes, in a special cavity built for it.

The same company, in co-operation with Varian Associates, approached the ultra-highs from the opposite direction, with a velocity-modulated tube. These tubes, best known under the Sperry trademark *Klystron*, are normally built for centimeter waves, and the spectrum between 500 and 1,000 mc looks like very low frequency to them. But, as it was possible to get up into the ultra-highs with conventional tubes by making them smaller and reducing element spacing, so by building bigger it was possible to get down into the u.h.f. television band with a velocity-modulated tube. The result is shown in Photo B, a picture of the big tube in place in an experimental transmitter. The two large cylinders that look like coiled wire are just that. They are focusing coils to control the beam of electrons as it "drifts" down the tube in regular velocity-modulation style.

On the receiving end, the little magnetron described in our January issue appeared with means for tuning it over a band comparatively wide for a magnetron. Acting as a receiver oscillator, it is expected to do for u.h.f. reception what the bigger tubes just described will do for transmission. A demonstration setup, with the tube, tuning equipment, and a meter to show output against frequency, appears in Photo C.

Still another possible future aid to u.h.f. television and other receiving circuits was a miniature traveling-wave

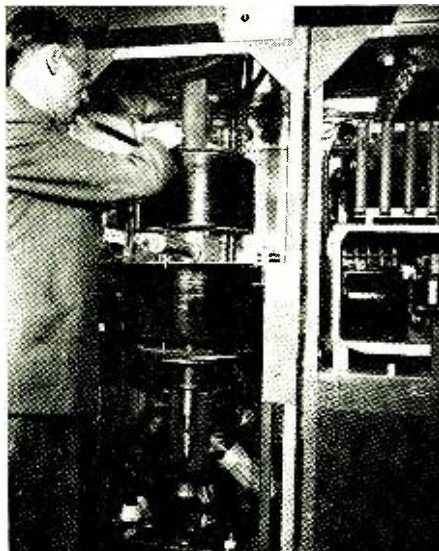

Photo B—G-E Engineer H. M. Crosby is adjusting the u.h.f. velocity modulated tube which operates at around 500 mc.



Photo C—Another G-E showpiece was the miniature magnetron for u.h.f. TV. Here H. W. A. Chalberg makes an adjustment on a demonstration circuit.

tube (Photo D) described by Robert Adler of Zenith. Means of adapting standard receivers to u.h.f. were also discussed. A paper on a u.h.f. converter for standard television receivers was read by B. F. Tyson of Sylvania. He described it as a low-cost design, giving adequate performance, which should serve a useful purpose in the early years of u.h.f. television broadcasting.

For the audio man?

Another component that may have revolutionary applications is the *Plasmatron*, described by E. O. Johnson of RCA Laboratories. The Plasmatron is a gas tube that will respond to audio or low-frequency radio signals. The secret of this tube is in its two cathodes. The regular cathode and anode have a relatively low voltage between them, as shown in Fig. 1. An auxiliary cathode



Photo D—Miniature traveling wave tube.

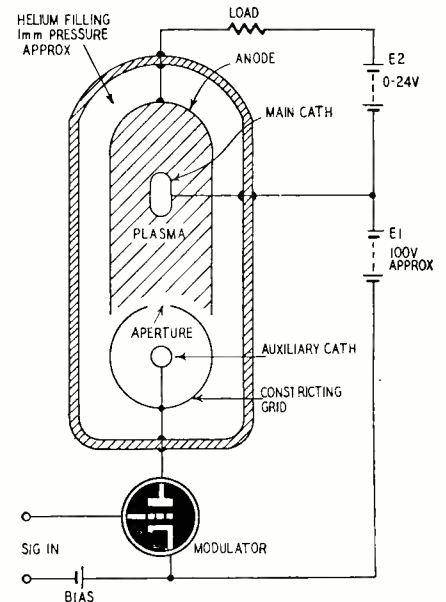

Fig. 1—Diagram of a Plasmatron in a series feed hookup. Note two cathodes.

the BIG VALUES come from ALLIED

Look to ALLIED for the outstanding values in popular equipment. Take advantage of the quality "buys" listed below—you'll save money and get top performance. Stocks of some of the listed items are limited—so order early to avoid disappointment.



New National SW-54 Receiver. The ultra-compact, quality low-cost communications receiver for the SW listener and novice Ham. Covers 4 bands: 540 kc to 30 mc—for standard AM, foreign and domestic shortwave, police, ships, aircraft and Amateur reception. Features: Bandspread tuning; 0-100 logging dial; AM-CW switch; receive-standby switch; speaker-headphone switch; PM speaker. In handsome gray enamel steel cabinet, 11" x 7" x 7". For AC-DC. With all tubes. Shpg. wt., 15 lbs.

97-711. SW-54 Receiver. Only

\$4995



Hallicrafters S-38B All-Wave Receiver. The all-star, all-wave value. Covers 4 full bands, continuous from 540 kc to 32 mc. Features: Electrical Bandspread; Band Selector; Voice-Code switch; Speaker-headphone switch; Standby-receive switch; latest PM speaker. Furniture-steel cabinet, 12 7/8 x 7 x 7 1/4". Complete with all tubes. For 105-125 volts DC, or 40-60 cycles AC. Shpg. wt., 15 lbs.

97-508. Model S-38B Receiver. **\$4950**
Only.....

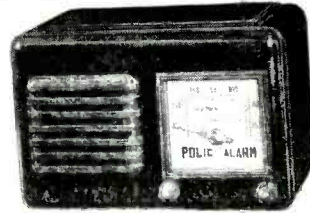

Police-Alarm VHF FM Receiver. Now—excellent for home or fixed location reception of taxicab and mobile commercial dispatches on 152-162 mc band. Ideal for monitoring use by taxicab operators, hospital personnel, and bus, truck and railroad dispatchers' radio nets. Superhet circuit; ratio detector and drift compensation; 100 kc. selectivity, 10 mv. sensitivity; full-vision dial calibrated in mc; PM speaker. In walnut-finished cabinet, 11 x 6 x 6". With vertical 16" stub antenna. For AC-DC operation. 8 lbs.

97-908. Model PR-8. Only **\$4495**



Hallierafters HT-17 Transmitter. The ideal CW rig for the beginner. 10 watts output on 80, 40, 20, 15, 10 meters. Uses 6V6GT crystal oscillator driving an 807 final. Controls: Plate Tuning, Antenna Loading, Standby, Meter Switch, Power on-off. Rear terminals for antenna, ground, key, external modulator. Satin-black steel cabinet, 12 7/8 x 6 7/8 x 7 7/8". For 105-125 v., 50-60 cy. AC. Complete with tubes and all coils for above bands. Less crystal. Shpg. wt., 25 lbs.

97-580. HT-17 Transmitter. **\$3950**
Only.....

Quantity Limited, Subject to Prior Sale



New PE-103 Dynamotor. Big, husky power unit ideal for use with mobile equipment. Operates from either 6 or 12 volt battery. Completely filtered output, all input and output circuits protected by circuit-breakers and safety relay. 10-foot battery cables. Brand-new units at a fraction of the original cost. Shpg. wt., 100 lbs.

98-101. PE-103 Dynamotor. Only.....
Quantity Limited, Subject to Prior Sale

\$1995



Knight 3-Way Portable. A top ALLIED portable value. Operates from AC, DC or self-contained batteries. Superhet circuit tunes full 535 to 1650 kc. Features: Alnico PM speaker, built-in loop antenna, full-vision dial, automatic volume control, selenium rectifier for instantaneous playing. In beautiful simulated leather carrying case with handsome plastic front panel; 8 3/4 x 5 1/4 x 4 3/4". With tubes, less batteries, 6 lbs.

5F-565. Knight Portable. Only **\$2085**
80-596. Battery Kit. 2 1/2 lbs. Only **\$.211**

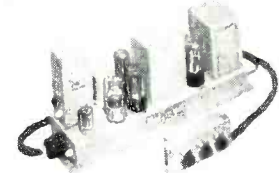

Audio Development 71-F Amplifier. A low-cost remote-controlled amplifier with excellent frequency response, ±.5 db, 40-10,000 cps. Output, 8 watts at less than 2% distortion. With bass and treble boosts. Crystal phono input (use plug-in preamp for magnetic cartridges). Outputs: 4, 8, 16 ohms. Controls on remote panel. Size: 16 x 6 7/8 x 3 3/4". Complete with tubes. For 110-120 v., 60 cy. Shpg. wt., 14 lbs.

97-910. Model 71-F. Only **\$4998**
97-911. Plug-in Preamp for magnetic cartridges. 3 lbs. Only **\$.735**



Ward TV Antenna. Uni-directional, efficient in-line all-channel TV antenna. Folded di-pole high and low band elements for broad response. Complete with 5-foot mast, base and 60 feet 300-ohm twin-lead; less insulators. Shpg. wt., 10 lbs. **Quantity Limited. 97-397. Only.....\$1075**

Knight Indoor Antenna All-channel, adjustable type for good reception within primary service areas. Each element has 3 telescoping sections, adjustable for best reception. With 10-foot twin-lead. Shpg. wt., 2 lbs. **Quantity Limited. 97-357. Only.....\$291**



free 212 PAGE ALLIED CATALOG

Send for the only complete Buying Guide to everything in Radio, TV and Industrial Electronics. Make your selections from the world's largest stocks of quality equipment—at lowest, money-saving prices. Write for your FREE copy of the 212-page ALLIED Catalog today.

ALLIED RADIO CORP.

833 W. Jackson Blvd., Chicago 7, Ill., Dept. 2-F-0

- Send FREE 212-Page ALLIED Catalog
- Enter order for:.....

Enclosed \$..... Full Payment Part Payment (Bal. C.O.D.)

Name.....

Address.....

City..... Zone..... State.....

ALLIED RADIO

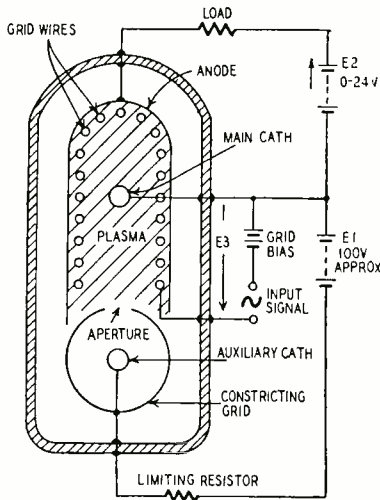

Fig. 2—Plasmatron circuit using grid.

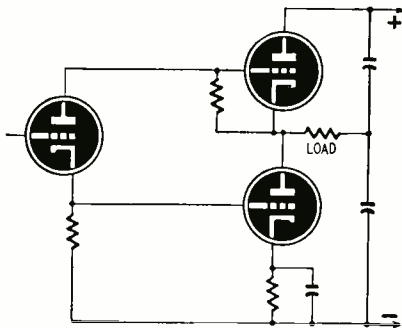

Fig. 3—Single-ended push-pull circuit.



Photo E—The G-string u.h.f. antenna.

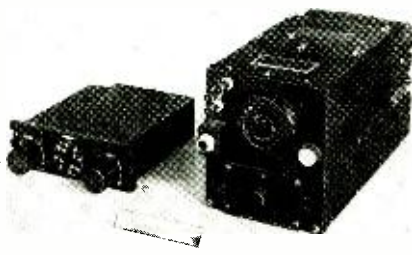

Photo F—Miniature aircraft receiver.

is operated at about 100 volts negative to the main cathode. Electrons from this cathode ionize the helium gas in the tube. Two modulation methods are possible. In Fig. 1 the signal is applied in series with the auxiliary cathode, and the varying electron stream from that cathode changes the conductivity of the ionized gas, or plasma, between main cathode and anode, thus varying the current in that circuit as well. Fig. 2 illustrates the second method. A grid is inserted between main cathode and anode, with the auxiliary cathode still ionizing the gas. Due to low plate voltage and the tube design, the grid does not lose control, but compels the main cathode-anode current to follow an input signal.

The new tube is still in the experimental stage, but very interesting applications suggest themselves. Most exciting is the possibility that it might match a loudspeaker without an output transformer, the Plasmatron working directly into a voice coil.

Single-ended push-pull

A single-ended push-pull amplifier was another paradoxical-sounding device. Described by Arnold Peterson and Donald B. Sinclair of General Radio Co., it is a true push-pull stage, as shown in the simplified diagram, Fig. 3. The two tubes are in series across the d.c. supply and the load is connected between the junction point of the two tubes to the plate supply. In practical circuits this is done with the help of a special output transformer, with separate windings through which the screens of pentode amplifiers may be fed. The grids of the two tubes are fed 180° out of phase, in true push-pull style.

The advantage of the circuit is that it has a very low output impedance—between 200 and 300 ohms with high-perveance tubes. It is conceivable that high-impedance voice coils might be designed which would permit this circuit to operate without an output transformer. The circuit maintains the advantage of push-pull cancellation of distortion, and in addition is able to supply a single-ended load.

Strangely enough for an organization whose members depend to no small extent on commercial broadcasting for their living, the paper which received the most lively reception was the *Practical Speech Silencer* described by R. Clark Jones. The paper was sponsored by the Polaroid Corporation, though the device is Mr. Jones' personal invention. No details were available pending application for patent, but the designer made it known that the equipment depends on the abruptness of the sounds in speech as opposed to the more continuous character of a musical program. A few clearly enunciated syllables sufficed to cut off the program, which started again after a few bars of music. Demonstrated with recorded segments of radio programs, the instrument brought howls of applause from the assembled engineers.

An interesting feature was the way

singing commercials were treated. The silencer cut them off like speech. Mr. Jones explained that since the advertiser was especially interested in getting his message across, the enunciation in a singing commercial was so clear and careful as to be more like speech than music, and was silenced, though ordinary songs were not cut off.

More was heard on the G-string, that fantastically wide-band and inexpensive high-frequency transmission line originally reported in *RADIO-ELECTRONICS*, May, 1950, and further described in Samuel Freedman's article, page 24 in this issue. Latest application is the G-string antenna mast shown in Photo E. The signals travel along the surface of the mast rather than inside a cable, then are reflected by the two flat plates, which, mounted at 45°, send the waves in a horizontal direction.

Miniaturization methods

More progress was shown in sub-miniaturization. The Bureau of Standards showed a 12-tube receiver for aircraft use which tunes from 190 to 550 kc and has a 135-kc i.f. Its size is shown graphically in Photo F, where it sits beside its well-known World War II equivalent, and the interior construction is shown in Photo G.

The Signal Corps exhibited an "auto-assembly" system of miniature construction which is almost the reverse of the printed circuit. The circuit is drawn on a copper-foil covered ceramic plate. Then the *undesired* parts are etched off.

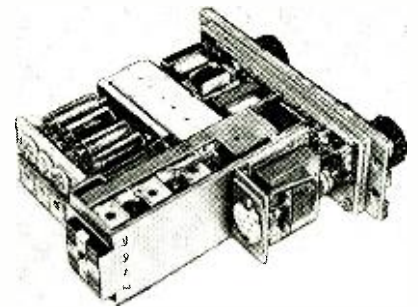
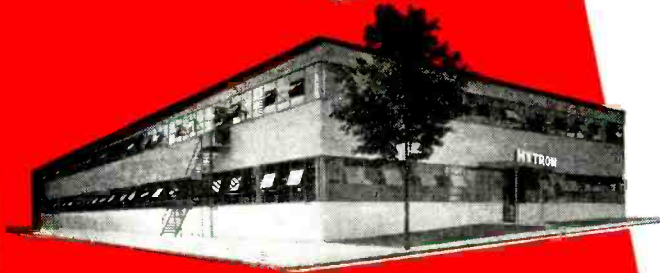
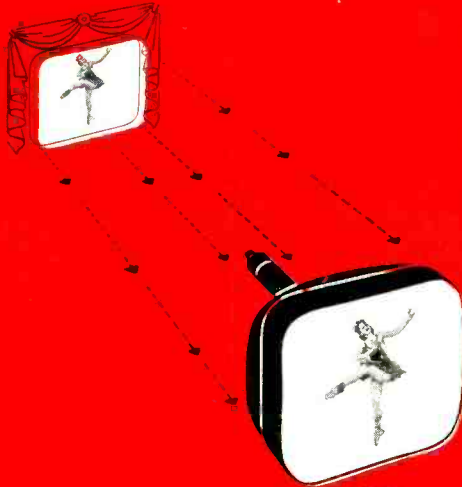

Photo G—The miniature set's insides.



Photo H—The miniature d.c. amplifier.

WHAT YOU GAIN WHEN YOU BUY...



LEADING TV SET MANUFACTURERS PICK HYTRON RECTANGULARS:
 ADMIRAL • AIR KING • BENDIX • CROSLEY • EMERSON
 HALLICRAFTERS • HOFFMAN • MOTOROLA • NATIONAL
 OLYMPIC • SENTINEL • SETCHELL-CARLSON • SPARTON
 STROMBERG-CARLSON • TRAV-LER • WESTINGHOUSE
 AND OTHERS

WATCH ALSO FOR THE
 NEW HYTRON 14-, 17-,
 AND 20-INCH ELEC-
 TROSTATIC RECTAN-
 GULARS

HYTRON *Studio-Matched* RECTANGULARS

- 1 **You get THE ORIGINAL.** The *studio-matched* rectangular tube is Hytron's baby. Its logically designed screen matches the 4 by 3 aspect ratio of the studio picture. Quite naturally, Hytron's new rectangular is fast becoming the most popular picture tube.
- 2 **You get UNIFORMITY.** Hytron's new picture-tube plant is the most modern in the world. It was designed especially to mass-produce Hytron *studio-matched* rectangulars of uniform dependability.
- 3 **You get A COMPLETE LINE.** Hytron offers you 14-, 16-, 17-, and 20-inch *studio-matched* rectangulars. All the popular rectangulars (and the popular types of round tubes too).
- 4 **You get THE QUALITY LEADERS DEMAND.** Nine out of ten leading TV set makers choose Hytron. More and more leading service-dealers pick Hytron. Because their own experience proves Hytron *studio-matched* rectangulars give "amazingly clearer, sharper, more brilliant pictures." Demand this same performance for yourself. Demand original Hytron *studio-matched* rectangulars.

OLDEST MANUFACTURER OF RECEIVING TUBES
HYTRON
 RADIO AND ELECTRONICS CORP.



MAIN OFFICE—SALEM, MASSACHUSETTS.

HERE'S HELP—



Now—in 1800 pages

All data, basic knowledge, methods and theory of Radio, Television, Electronics, digested into 32 Sections in complete, quick to find, easy to read Handbook form.

Plan every operation in Radio-TV and Electronics with this library set consisting of The Radio Electronics Handbook and the Video Handbook. These Handbooks will be your lifelong tools—you will use them every day on the board, at the bench, in the field. Use them for construction, production, installation, operation—use them for adjusting, troubleshooting, measuring and testing. They will be your invaluable aid in research, design, development, manufacturing or maintenance. With data and servicing procedures complete, they will make your work faster, better, easier.

They give complete coverage of everything in Radio, TV and Electronics—and you will find them easy to use—everything is presented in plain language—all terms explained; schematics, working diagrams and pictures are clearly illustrated for fast and easy understanding.

The Radio Electronics Handbook and the Video Handbook are works of complete authority prepared by the well-known engineers Scheraga & Roche, under the direction of William F. Boyce, famous for the preparation of hundreds of handbooks and manuals for the U. S. Signal Corps, Navy Communications, Air Force Electronics Section, Western Electric Co., General Electric Co., Bell Laboratories, R. C. A., Sylvania, DuMont Laboratories, National Radio Co. and many others.

These Handbooks are endorsed by leading schools for instruction and reference. The armed services make them available to their technicians in libraries, schools and in the field. Engineers, Draftsmen, Laboratory and Production men in every industry have purchased over 50,000 of these books for use in their work.

500 Radio jobbers keep them constantly in stock for the convenience of their service and industrial customers. These are the most commonly used books in Radio & TV.

Contents are too long and complete to describe here—so, see them at your Radio jobber, your bookstore, or send for them on free examination. See for yourself what they will do for you.

SEND NO MONEY

10 DAY FREE EXAMINATION

SPECIAL OFFER:

Save one dollar—get both handbooks as shown above in library set for \$10.90.

"COUPON"	
BOYCE ROCHE BOOK CO. Caldwell 46, New Jersey	
Send ()	Library Set (2 books) @ \$10.90
()	Radio Electronics Handbook @ \$5.95
()	Video Handbook @ \$5.95
In ten days I will send price plus postage, or I will return books postpaid.	
(Offer good in U.S.A. and to men in Armed Services overseas only.)	
Name
Address
Employed by
Save postage—we pay postage and packing if you send money NOW. Money back on same return privilege.	

leaving the circuit in copper lines. Components are attached along these lines by pushing their leads through pre-fabricated holes in the plates, and the whole dipped in solder, to produce a small, rugged unit of excellent conductivity and extreme ease of assembly.

The miniature high-frequency d.c. amplifier of Photo H is the result of normal miniaturization plus reducing the number of parts. The old-type conventional amplifier, beside it, uses at least 240 parts, whereas the new one requires only 35. The amplifier was described by E. L. Crosby, Jr., of Bendix Radio, who pointed out that the new circuit technique which made this amplifier possible, in addition to making the amplifier smaller, reduced the

chances of component failure, since the fewer the parts, the fewer the opportunities for component breakdown. Designed at present for radar, the amplifier may find wide application in the higher frequencies.

The most striking general impression that a visitor to the show got was that we are still only treading lightly around the obscure boundaries of a vast new era of electronics. The items described in this article and many other items at the show seem to be only the basic components that may become essential parts of entirely new systems, the likes of which we cannot yet fully imagine. We shall no doubt see our progress into this new era more clearly at next year's I.R.E. show.

—end—

New Tubes of the Month

As electrostatically focused kinescopes will soon be making their appearance in more and more new large-screen televisers, it would be well to review their characteristics briefly. Three models are now or will soon be in production by major tube manufacturers, the 14GP4, 17FP4, and 20FP4. These tubes do not use focusing magnets, but have a special gun design which allows the beam to be focused with a zero-current electrostatic potential.

The focusing voltage is about 25% of the second anode potential. It can be obtained from a bleeder across the high-voltage supply. This is generally unsatisfactory because the added drain on the h.v. rectifier will drop the picture tube voltage and the regulation is poor. A better method is to use a separate rectifier, fed from the horizontal output tube plate. Circuits for doing this appear in the May issue of RADIO-ELECTRONICS on page 27.

The Rauland company has announced another electrostatically focused picture tube type which uses from 150 to 350 volts for focusing, but technical data is not yet available.

A new secondary emission, wide-band amplifier tube having a transconductance of 25,000 micromhos and for use at frequencies up to 200 mc is announced by National Union. Designated as type 5857, the tube is contained in a miniature envelope with a 9-pin base. It is also useful as a square wave generator, providing rise times on the order of .005 microseconds.

The construction of the 5857 is such that the electrons pass through the grids in the usual manner and then strike a dynode. Here, through secondary emission, the current is increased by a factor of four and proceeds to the plate. In a sample three-stage, stagger-tuned amplifier, 20 mc wide and centered at 100 mc, these tubes produce an overall gain of 1,200. The same circuit using 6AK5's has a gain of only 47. The tube is intended for radar use and other special applications, where its high cost is not important.

RCA has a new flying-spot cathode-ray tube, the 5ZP16. It is designed for high-quality video signal generators. A

flying spot generator produces still pictures, like a monoscope, but has the advantage that the picture may be



The 5ZP16 flying-spot cathode-ray tube.

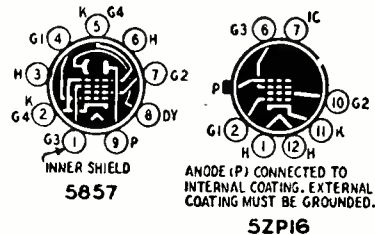

Basing diagrams of the two new tubes.

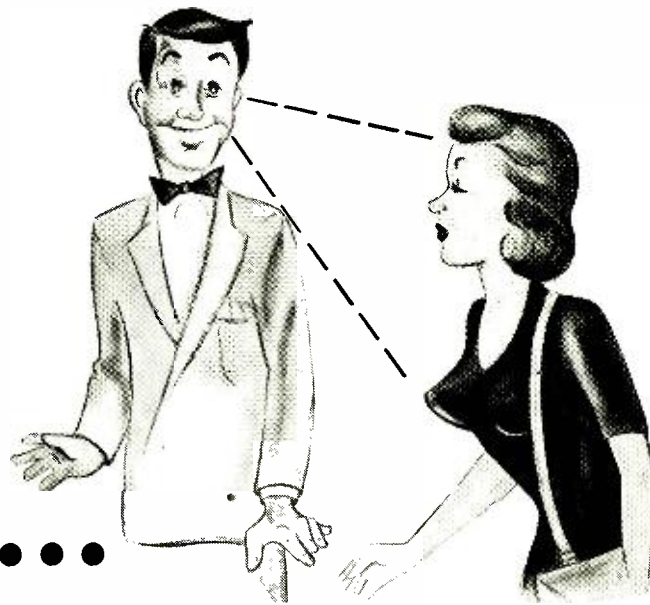

Photo of the secondary emission tube.

changed at will and has a halftone fidelity like that of photographic film. This tube supersedes the 5WP15 for new equipment design.

—end—

**NO
EYE
STRAIN...**



WITH A

Sheldon "Telegenic" Picture Tube

where

BLACK IS BLACK - WHITE IS WHITE -

and between

ALL THE NATURAL INTERMEDIATE SHADING!

PLEASANT, visual-comfort, continuous viewing without eyestrain can only be had on a picture tube screen that has neither "tints" nor color to befog the picture. A "yellow" or a "blue" screen tube compels the viewer's eyes to compensate for the inequalities and exaggerations in picture tone values, such as muddy "off" blacks and glarey or tinted highlights. Anyway you look at it, this causes eyestrain.

That is why SHELDON was the first to standardize on a "black and white" screen. Its picture tube screens cause **NO EYESTRAIN** and **NO GLARE** . . . they give the utmost in picture quality.

To You in the Television Industry,
TRY A SHELDON TUBE IN YOUR OWN SET FOR SEVEN DAYS
— and **BE CONVINCED!**

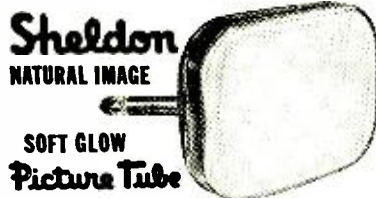

MAIL COUPON TODAY

SHELDON ELECTRIC CO.

A Division of **ALLIED ELECTRIC PRODUCTS INC.**

68-98 Coit Street, Irvington 11, N. J.

Branch Offices & Warehouses: 426 S. Clinton St. CHICAGO 7, ILL.
1755 Glendale Blvd., LOS ANGELES 26, CAL.

SHELDON ELECTRIC CO., 68 Coit Street, Irvington 11, N. J. 6
Send Me FREE

Booklet, Visual Proof of Sheldon Picture Quality
 "Television Mis-Information", Sheldon's Famous Trade Magazine

"Tube Specifications Wall Chart"—June Edition
 "ION BURNS—and How to Prevent Them" Folder

Name..... Position.....
Company.....
Street..... ADDRESS TO WHICH THIS SHOULD BE MAILED
City..... Zone..... State.....

SHELDON TELEVISION PICTURE TUBES • CATHODE RAY TUBES • FLUORESCENT STARTERS AND LAMP HOLDERS • SHELDON REFLECTOR & INFRA-RED LAMPS
PHOTOFLOOD & PHOTOSPOT LAMPS • SPRING-ACTION PLUGS • TAPMASTER EXTENSION CORD SETS & CUBE TAPS • RECTIFIER BULBS

© 1951—ALLIED ELECTRIC PRODUCTS INC.

Four-Band C. W. Ham Transmitter

Plug-in coils in the final stage select ample output on 15, 20, 40, or 80 meter bands, eliminating complex bandswitching

By I. QUEEN

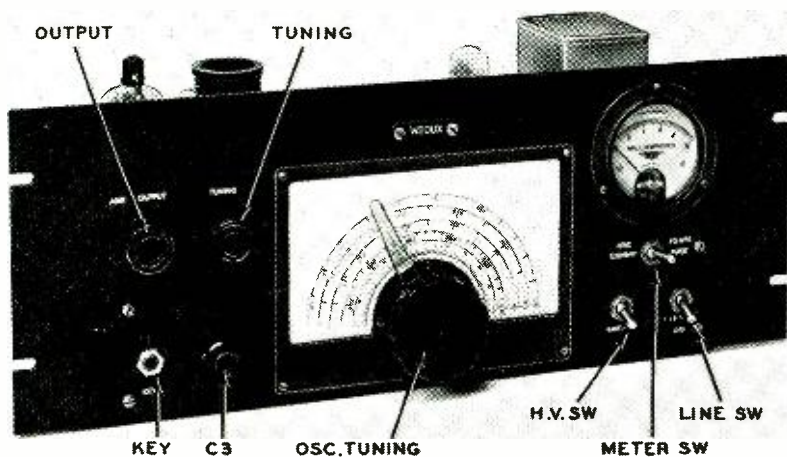

The transmitter panel. The meter reads the 807 grid current and power input.

THIS transmitter operates on several ham bands without complicated switching. It is based on the excellent Clapp or series-tuned oscillator. Except for the final high voltage, all grid, filament, and plate power supplies are self-contained. (See Fig. 1) The v.f.o. (6AK5) resonates in the 80-meter band. A screen-grid amplifier (6SJ7) follows, also on 80. Next is a broad-band stage (6V6) tuned to 40 meters. No neutralization is required and there is ample output on both 40 and 80 meters from this tube. The final (807) operates straight through on either 40 or 80, and it doubles or triples for 20 or 15. Although output is maximum on 40, there is only little tapering off at 15, 20, and 80. The output band is chosen by plug-in coils.

The oscillator is built within a 3 x 4 x 5-inch metal box without top and bottom covers. This box is screwed beneath the 15 x 7 x 3-inch transmitter chassis. When the chassis bottom cover is put in place, the oscillator is completely shielded. Only the 6AK5 extends outside the box and this is shielded also.

For best results L1, the oscillator coil, must have high Q and be ruggedly built. After trying several we came across the power amplifier coil (7-9 mc) for the BC-459. This proved excellent for the job and is available at very low cost as surplus. The coil is a variometer. The outer winding has heavy wire on a grooved ceramic form 1½ inches in diameter. It has 15 turns occupying about ¾ inch, then a ¼-inch space, then 5 more turns. The inner winding of 4 turns is arranged to rotate through 180° and the total inductance is variable over a considerable range. There is also a slug for fine adjustment.

When the BC-459 coil was wired in, the low-frequency end of the tuning range came just above 3.5 mc. Therefore we removed about ¼ turn from the outer winding. The variometer control is adjusted to reach 3.5 mc with the tuning capacitor at maximum. The high-frequency limit will then be above 3.75 mc, or a little more than half the band. The limited range is convenient for multiplying into the other bands. Incidentally, the fourth harmonic of 3.75 mc makes a good check point against WWV at 15.0 mc.

Subsequent minor retuning may be done with the slug at the top of the coil. It is reached by a long screwdriver through a hole drilled through the transmitter chassis.

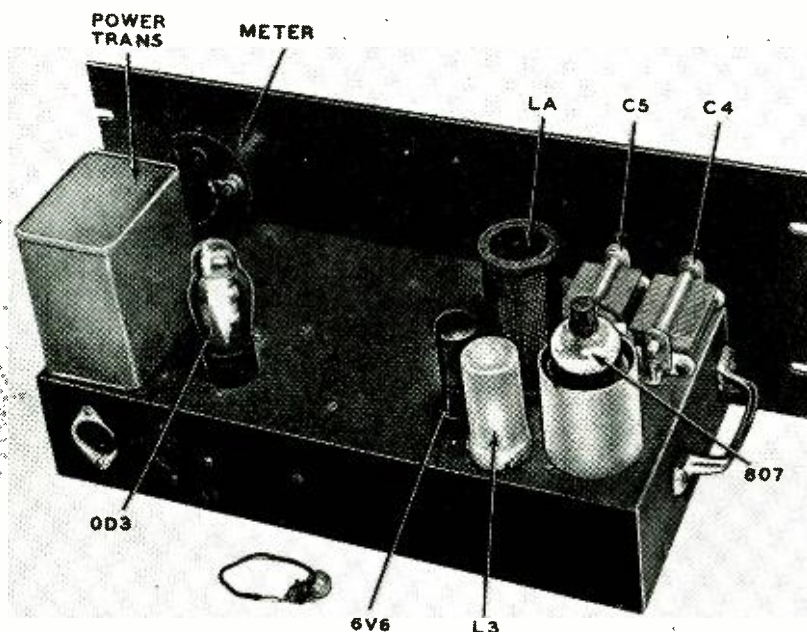

The transmitter from the rear. The plug-in coil marked LA is the output coil L4.

Superior's New Model 670

SUPER-METER

A COMBINATION VOLT-OHM MILLIAMMETER PLUS CAPACITY REACTANCE INDUCTANCE AND DECIBEL MEASUREMENTS



SPECIFICATIONS:

D.C. VOLTS: 0 to 7.5/15/75/150/750/1,500/7,500 Volts
A.C. VOLTS: 0 to 15/30/150/300/1,500/3,000 Volts
OUTPUT VOLTS: 0 to 15/30/150/300/1,500/3,000 Volts
D.C. CURRENT: 0 to 1.5/15/150 Ma. 0 to 1.5 Amperes
RESISTANCE: 0 to 500/100,000 Ohms 0 to 10 Megohms
CAPACITY: .001 to .2 Mfd. .1 to 4 Mfd. (Quality test for electrolytics)
REACTANCE: 700 to 27,000 Ohms 13,000 Ohms to 3 Megohms
INDUCTANCE: 1.75 to 70 Henries 35 to 8,000 Henries
DECIBELS: - 10 to + 18 + 10 to + 38 + 30 to + 58

ADDED FEATURE:

The Model 670 includes a special GOOD-BAD scale for checking the quality of electrolytic condensers at a test potential of 150 Volts.

The Model 670 comes housed in a rugged, crackle-finished steel cabinet complete with test leads and operating instructions. Size 5 1/2" x 7 1/2" x 3".

\$28⁴⁰
NET

The New Model 200

AM and FM SIGNAL GENERATOR

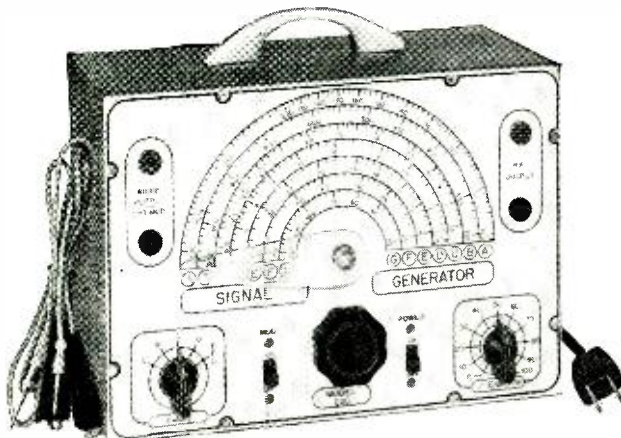

SPECIFICATIONS

- ★ **R.F. FREQUENCY RANGES:** 100 Kilocycles to 150 Megacycles.
- ★ **MODULATING FREQUENCY:** 400 Cycles. May be used for modulating the R.F. signal. Also available separately.
- ★ **ATTENUATION:** The constant impedance attenuator is isolated from the oscillating circuit by the buffer tube. Output impedance of this model is only 100 ohms. This low impedance reduces losses in the output cable.
- ★ **OSCILLATORY CIRCUIT:** Hartley oscillator with cathode follower buffer tube. Frequency stability is assured by modulating the buffer tube.
- ★ **ACCURACY:** Use of high-Q permeability tuned coils adjusted against 1/10th of 1% standards assures an accuracy of 1% on all ranges from 100 Kilocycles to 10 Megacycles and an accuracy of 2% on the higher frequencies.
- ★ **TUBES USED:** 12AU7—One section is used as oscillator and the second is modulated cathode follower. T-2 is used as modulator. 6C4 is used as rectifier.

The Model 200 operates on 110 Volts A.C. Comes complete with output cable and operating instructions.

\$21⁸⁵
NET

Superior's New Model TV-11

TUBE TESTER



Tests all tubes including 4, 5, 6, 7, Octal, Lock-in, Peanut, Bantam, Hearing-a-id, Thyatron, Miniatures, Sub-miniatures, Novals, Sub-Minars, Proximity Fuse Types, etc. Tests for "shorts" and "leakages" up to 5 Megohms. Uses the new self-cleaning Lever Action Switches for individual element testing. Because all elements are numbered according to pin-number in the RMA base numbering system, the user can instantly identify which element is under test. The Model TV-11 does not use any combination type sockets. Instead individual sockets are used for each type of tube. Thus it is impossible to damage a tube by inserting it in the wrong socket. Newly designed Line Voltage Control compensates for variation of any line voltage between 105 Volts and 130 Volts.

EXTRA SERVICE

The Model TV-11 may be used as an extremely sensitive Condenser Leakage Checker. A relaxation type oscillator incorporated in this model will detect leakage even when the frequency is one per minute.

The Model TV-11 operates on 105-130 Volt 60 Cycles A.C. Comes housed in a beautiful hand-rubbed oak cabinet complete with portable cover.

\$47⁵⁰
NET

*NOISE TEST
Phono Jack on front panel for plugging in either phones or external amplifier will detect microphonic tubes or noise due to faulty elements and loose external connections.

MONEY BACK GUARANTEE!!

GENERAL ELECTRONIC DISTRIBUTING CO.
GENTLEMEN: PLEASE RUSH THE MATERIAL LISTED BELOW:

DEPT. RC-6, 98 PARK PLACE, NEW YORK 7, N. Y.
Phone—REctor 2-1677

QUANTITY	MODEL	PRICE
	670 SUPER METER	
	200 SIGNAL GENERATOR	
	TV-11 TUBE TESTER	
	TOTAL	

Name _____
 Address _____
 City _____ Zone _____ State _____
 \$ _____ \$ _____
 (Payment in Full Enclosed) (Deposit Enclosed—Ship Balance C.O.D.)

Tuning and adjustment

To put a signal on the air, plug in the desired coil L4. (See table.) Switch to GRID CURRENT. Tune the v.f.o. to the desired frequency. Adjust C3 for maximum meter reading. Now switch to POWER INPUT and turn on the high voltage to the final. With 450 volts the meter will show less than 15 watts input when the key is up. The reading will be almost 50 watts when the key is depressed. Tune C4 near maximum capacitance and resonate for a dip with C5. If more power is desired, reduce the C4 setting and retune with C5. With the antenna disconnected, the following dip values will be obtained:

3.5 mc	16 watts
7.0	5
14.0	17
21.0	19

These values show that ample output may be obtained on any of the bands but that maximum power can be radiated on the 7.0 mc band.

The pi antenna network will couple to any length antenna. We use a straight wire about 30 feet long and less than 20 feet above ground on all bands.

The oscillator should always be completely shielded before transmitting, especially on the 3.5 mc band. Oscillator blocking may result in poor signal quality or chirp. Also, C3 should never be left too far off resonance. No difficulty is being encountered here due to r.f. feedback. If this problem is met, chokes or 100-ohm resistors may be added in the power leads to the oscillator. We did, however, detect a v.h.f. parasitic in the final. A small choke of 20 turns of fine wire around a 1/2-watt resistor (25,000 ohms) cured this immediately. Keying the oscillator shows no ill effects on signal quality.

Band (mc)	Turns	Dia. (inches)	Length (inches)	Wire size
3.5	30	1 1/2	2 1/4	20
7.0	16	1 1/2	1 1/4	20
14.0	7	1 1/4	1	20
21.0

This transmitter is definitely superior to our early v.f.o. built in 1946 (see June-July, 1947, RADIO-CRAFT). It operates on more bands, is more efficient, and all tubes run much cooler.

Materials for Transmitter

Resistors: 1-47; 1-330; 1-620; 1-3,300; 1-15,000; 1-27,000; 1-47,000; 2-100,000-ohm, 1-1 megohm, 1/2 watt; 1-1,000; 1-15,000-ohm, 1 watt; 1-25,000-ohm 10 watt; 1-2,000; 1-5,000-ohm, 5-watt, adjustable. Also 2 meter shunts (see text).
 Capacitors: 2-150; 3-100; 3-2,000-μf, mica; 1-.002-μf, 1-kv, mica; 1-50-μf variable (screw adj.); 1-50-μf midjet variable; 1-19-plate midjet variable; 2-.003-μf variable transmitter; 5-.02-μf, 400-volt paper; 1-.01-μf, 1-kv, paper; 2-8-μf, 450-volt, electrolytic; 1-16-μf, 250-volt, electrolytic.
 Inductors: Power transformer, 235-volt with 85-volt tap and 6.3-volt, 3-amp winding (see text); 2-2.5-mh, 1-1-mh, 1-10-h, 60-ma, chokes; 1-parasitic choke (see text).
 Miscellaneous: 1-6AK5, 1-6SJ7, 1-6V6, 1-807, 1-OD3 tubes and sockets; 1-d.p.d.t., 2-s.p.s.t., switches; 3-75-ma selenium rectifiers; 1-0-1-milliammeter; key jack, knobs and dial, chassis, hookup wire, and assorted hardware.

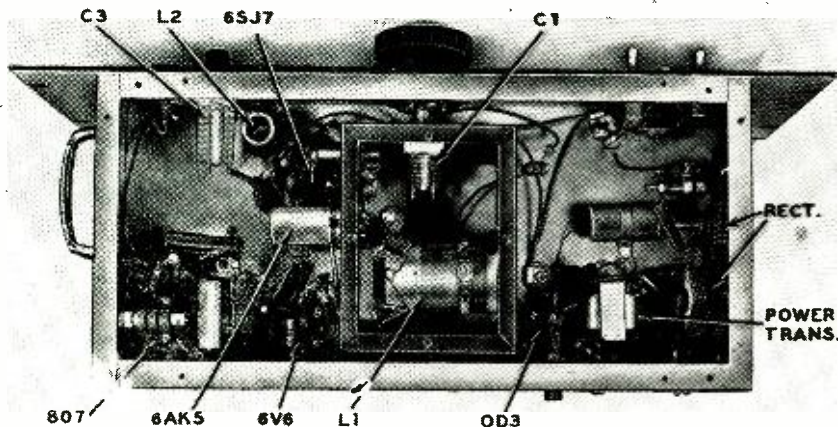

A bottom view. The metal sub-chassis contains the Clapp oscillator circuit.

The 6SJ7 plate is tuned to the fundamental of the v.f.o. L2 is 30 turns of No. 22 wire wound on a 3/4-inch diameter form. C2 sets the band and C3 tunes it. One setting of C3 is enough to work any narrow band such as 3.5-3.6 mc (or harmonics thereof).

L3 is a Millen slug-tuned coil form (No. 74001). It is wound with 32 turns of No. 26 wire. The form plugs into an octal socket, and the slug should be adjusted for maximum output near 7 mc. This may be indicated by a wavemeter. Then screw down the shield over the coil form. Set the v.f.o. to 3.57 mc and note the grid current of the 807. Now the coil slug is tuned from the bottom (since the shield is in place over the

is equivalent to 50 watts input. It is more convenient to calibrate the meter in terms of POWER INPUT than merely plate ma. In any case R2 will depend upon the meter used as well as the plate supply voltage.

The power supply for the first three tubes is conventional. The transformer, a surplus device, has 150- and 85-volt windings. These are connected in series for a total of 235 volts, and the 85-volt winding is used to supply bias for the final. Two rectifiers are used in series because of the high voltage. Regulated voltage is applied to the 6AK5 and 6SJ7. All tubes run relatively cool, since they are operated well below maximum ratings.

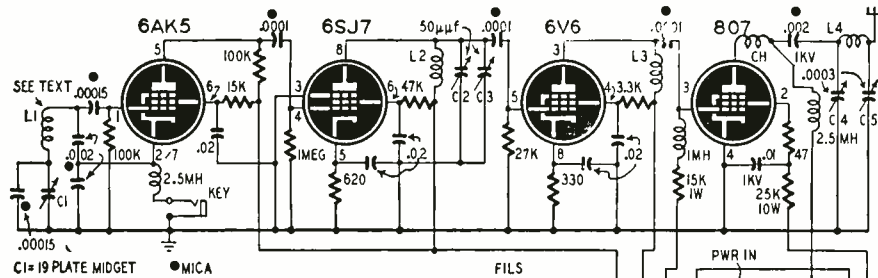
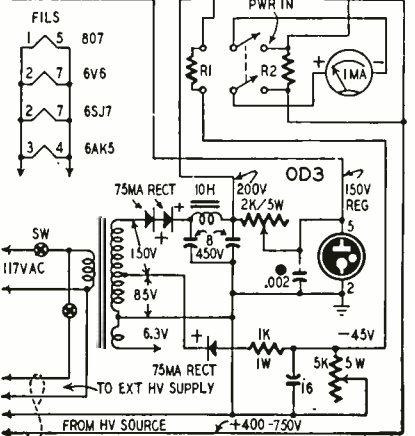

Fig. 1—The circuit of the multi-band transmitter. The unit is entirely self-contained except for the high-voltage supply for the final power amplifier.

top) for maximum current. This will be more than 3.5 ma. When this is completed, output will be fairly constant on all higher bands.

A measuring circuit is included to measure both grid and plate currents of the 807. When the toggle is thrown to GRID CURRENT, R1 shunts the meter and the scale is 0-5 ma. In the POWER INPUT position the meter is shunted by R2. The meter scale is then 0-110 ma. Since we use 450 volts on the plate, this



You can't see
INTERFERENCE
and **GHOSTS** on
a meter...

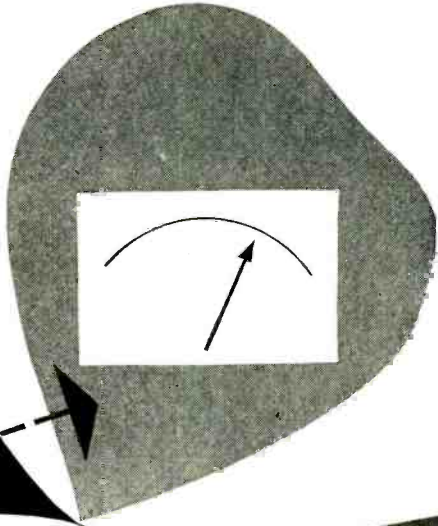

That's why smart
power companies
and TV servicemen
choose the
NATIONAL
VIDEOMETER

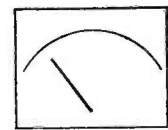
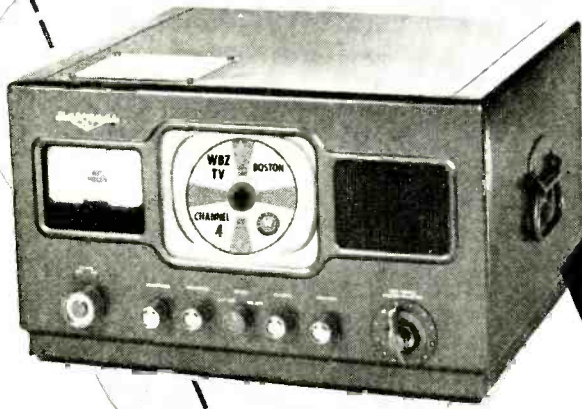

A. C. LINE ● SIG. STRENGTH

The National Videometer has proved an invaluable instrument to both power companies and TV servicemen in (1) locating the source of TV interference and (2) orienting TV antennas for ghost-free reception. For the National Videometer combines a sensitive TV receiver with an accurate meter for measuring field strength and A.C. line voltages. You see what you *measure . . . measure what you see!*

METER CHECK ON BOTH FIELD INTENSITY AND LINE VOLTAGE

Set the meter switch to A.C. LINE and read the line voltage at the receiver input terminal directly on the 0-150 volt scale. Set the switch to SIG. STR. and read the field intensity on the 0-10 scale. A table is provided to convert directly to microvolts. Reading is independent of contrast and brightness controls.

\$169.95
(Plus \$12.75 excise tax)



Cut QRM With Noise Limiters

Some noise limiter circuits that will make a marked improvement in your shortwave pickup

By ALVIN B. KAUFMAN, WØYOV

A GOOD noise limiter is important for shortwave reception, especially in the city. The lower frequency bands are troubled with static, and the higher frequency bands have QRM or man-made interference such as automobile ignition, street car noise, and random power-line corona.

A noise limiter simply removes any signal from the output whose level ex-

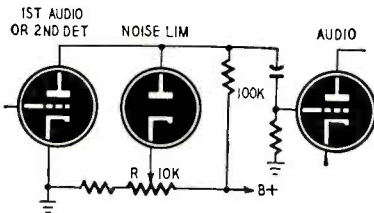

Fig. 1—A simple noise limiter hookup.

ceeds the average audio level of the transmitted signal. It must be adjusted so that it passes the audio signal level, but clips off any noise peaks or pulses extending above that level. It is apparent then that the limiter should be automatic in type, adjusting to the audio level.

Such limiters operate on the principle

that each individual noise pulse is of short duration, yet of high amplitude, and may produce noise peaks 10 to 20 times as great as the incoming radio signal. Because the duration of these noise peaks is short, the receiver can be cut off during the noise pulse and the human ear will not notice the loss of signal.

Limiters use one or more diodes either as clippers or gates in the a.f. system, the first being known as the *shunt* type and the latter as the *series* type. When the noise pulse exceeds a set value, the limiter diode acts either as a dead short or open circuit depending upon whether it clips or gates. These two most common type of limiters can be made automatic and much superior to any manually adjusted limiter.

A manually adjusted limiter is shown on Fig. 1 to indicate its simplicity. Potentiometer R is adjusted until the noise pulses cause the diode to conduct. When the diode conducts, it shunts the plate loading resistor with its low value of plate resistance until hardly any noise signal appears in this tube's plate circuit. The resistance of the potentiometer must not exceed about 10% of the plate resistor value or the noise diode could not effectively short out the plate resistor for its clipping action. Nor can

the potentiometer value be made too low or it will draw excessive bleeder current. The limiter control must be manually adjusted for each signal so as to not chop off any of the audio, which will vary in amplitude. Germanium crystals are not recommended for this circuit because chance high voltages may destroy them.

Two limiter circuits

A series-type noise limiter is shown in Fig. 2. Note that the addition of several resistors and the slight rewiring of one section of the 6H6 detector allows self-adjusting noise limiter action. The cathode of the limiter diode is maintained at a d.c. voltage developed by a.v.c. action, while its plate circuit voltage may fluctuate with any signal. The diode acts as a series gate, allowing audio to get to the grid of the a.f. tube only so long as the diode is conducting. Pulses which exceed the carrier level

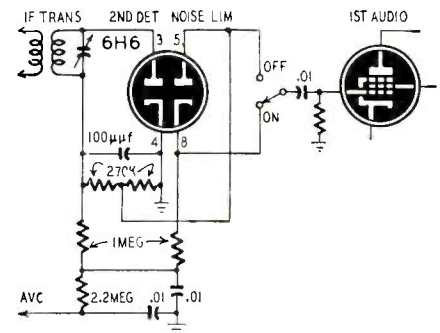

Fig. 2—This series noise limiter uses a.v.c. voltage for automatic control.

Largest Selling Booster

AT ANY PRICE !



Regency

19AP4?
19AP4A?
19EP4?

ARE YOU CONFUSED ABOUT PICTURE TUBES?



Get this helpful new Guide...

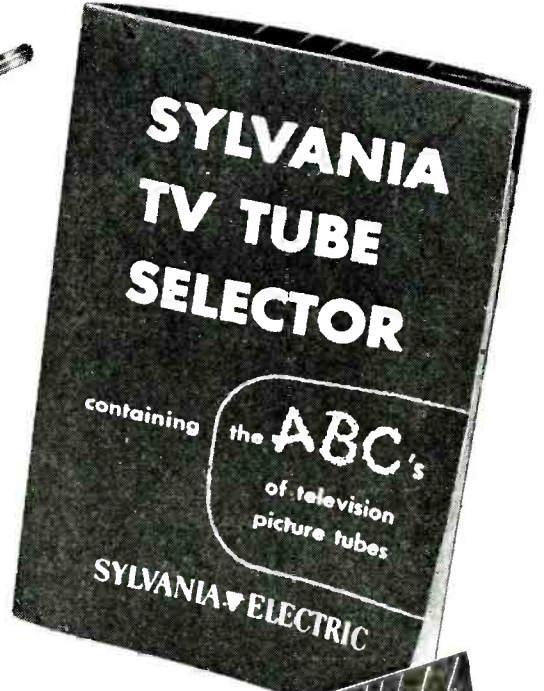

FREE FROM YOUR SYLVANIA DISTRIBUTOR

HERE'S the handiest little pocket guide since television came of age!

At a glance, it gives you the information you need concerning 100 different types of Television Picture Tubes.

Especially prepared for service men, it quickly indicates the difference between similar tubes having different suffix letters. More, it gives you facts about face plates, shape, glass or metal construction, conductive coatings, and price. A column is also left for your personal pencilled inventory notes.

Remember this guide is FREE. Your Sylvania distributor has them now. Ask him to give you a "Sylvania TV Tube Selector" when you next stop in or phone for those top quality Sylvania Tubes.

TYPE	FACE PLATE #	SHAPE	GLASS OR METAL	CONDUCTIVE COATING	PRICE	INVENTORY NOTES
14CP4	G	C	C	NO	\$35.00	
14DP4	G	C	C	NO		
14EP4	G	C	C	NO		
14FP4	G	C	C	NO		
14GP4	G	C	C	NO		
14HP4	G	C	C	NO		
14IP4	G	C	C	NO		
14JP4	G	C	C	NO		
14KP4	G	C	C	NO		
14LP4	G	C	C	NO		
14MP4	G	C	C	NO		
14NP4	G	C	C	NO		
14OP4	G	C	C	NO		
14PP4	G	C	C	NO		
14QP4	G	C	C	NO		
14RP4	G	C	C	NO		
14SP4	G	C	C	NO		
14TP4	G	C	C	NO		
14UP4	G	C	C	NO		
14VP4	G	C	C	NO		
14WP4	G	C	C	NO		
14XP4	G	C	C	NO		
14YP4	G	C	C	NO		
14ZP4	G	C	C	NO		
15AP4	G	C	C	NO		
15BP4	G	C	C	NO		
15CP4	G	C	C	NO		
15DP4	G	C	C	NO		
15EP4	G	C	C	NO		
15FP4	G	C	C	NO		
15GP4	G	C	C	NO		
15HP4	G	C	C	NO		
15IP4	G	C	C	NO		
15JP4	G	C	C	NO		
15KP4	G	C	C	NO		
15LP4	G	C	C	NO		
15MP4	G	C	C	NO		
15NP4	G	C	C	NO		
15OP4	G	C	C	NO		
15PP4	G	C	C	NO		
15QP4	G	C	C	NO		
15RP4	G	C	C	NO		
15SP4	G	C	C	NO		
15TP4	G	C	C	NO		
15UP4	G	C	C	NO		
15VP4	G	C	C	NO		
15WP4	G	C	C	NO		
15XP4	G	C	C	NO		
15YP4	G	C	C	NO		
15ZP4	G	C	C	NO		
16AP4	G	C	C	NO		
16BP4	G	C	C	NO		
16CP4	G	C	C	NO		
16DP4	G	C	C	NO		
16EP4	G	C	C	NO		
16FP4	G	C	C	NO		
16GP4	G	C	C	NO		
16HP4	G	C	C	NO		
16IP4	G	C	C	NO		
16JP4	G	C	C	NO		
16KP4	G	C	C	NO		
16LP4	G	C	C	NO		
16MP4	G	C	C	NO		
16NP4	G	C	C	NO		
16OP4	G	C	C	NO		
16PP4	G	C	C	NO		
16QP4	G	C	C	NO		
16RP4	G	C	C	NO		
16SP4	G	C	C	NO		
16TP4	G	C	C	NO		
16UP4	G	C	C	NO		
16VP4	G	C	C	NO		
16WP4	G	C	C	NO		
16XP4	G	C	C	NO		
16YP4	G	C	C	NO		
16ZP4	G	C	C	NO		
17AP4	G	C	C	NO		
17BP4	G	C	C	NO		
17CP4	G	C	C	NO		
17DP4	G	C	C	NO		
17EP4	G	C	C	NO		
17FP4	G	C	C	NO		
17GP4	G	C	C	NO		
17HP4	G	C	C	NO		
17IP4	G	C	C	NO		
17JP4	G	C	C	NO		
17KP4	G	C	C	NO		
17LP4	G	C	C	NO		
17MP4	G	C	C	NO		
17NP4	G	C	C	NO		
17OP4	G	C	C	NO		
17PP4	G	C	C	NO		
17QP4	G	C	C	NO		
17RP4	G	C	C	NO		
17SP4	G	C	C	NO		
17TP4	G	C	C	NO		
17UP4	G	C	C	NO		
17VP4	G	C	C	NO		
17WP4	G	C	C	NO		
17XP4	G	C	C	NO		
17YP4	G	C	C	NO		
17ZP4	G	C	C	NO		

This Selector will save you lots of time and bother . . . eliminate errors. Get your FREE copy!



SYLVANIA ELECTRIC

Sylvania Electric Products Inc., Television Picture Tube Division, Emporium, Pa.

TELEVISION PICTURE TUBES; RADIO TUBES; ELECTRONIC PRODUCTS; ELECTRONIC TEST EQUIPMENT; FLUORESCENT TUBES, FIXTURES, SIGN TUBING, WIRING DEVICES; LIGHT BULBS; PHOTOLAMPS; TELEVISION SETS

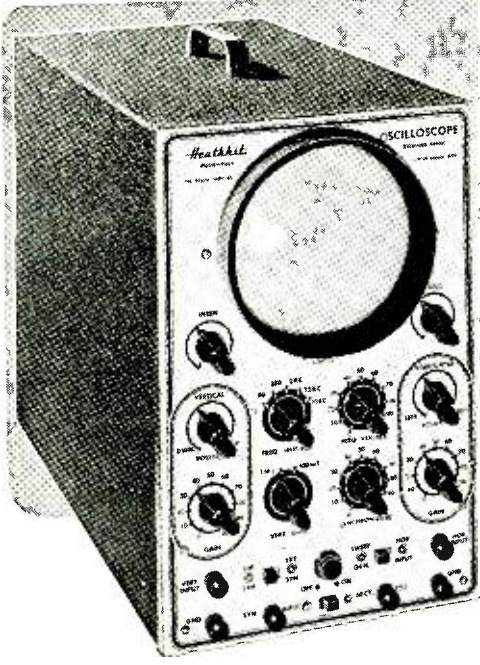

Heathkit MODEL 0-6... PUSH-PULL... 5" OSCILLOSCOPE KIT

The new Heathkit 5" Push-Pull Oscilloscope Kit is again the best buy. No other kit offers half the features — check them. Measure either AC or DC on this new scope — the first oscilloscope under \$100.00 with a DC amplifier.

The vertical amplifier has frequency compensated step attenuator input into a cathode follower stage. The gain control is of the non frequency discriminating type — accurate response at any setting. A push-pull pentode stage feeds the CR tube. New type positioning control has wide range for observing any portion of the trace. The horizontal amplifiers are direct coupled to the CR tube and may be used as either AC or DC amplifiers. Separate binding posts are provided for AC or DC.

The multivibrator type sweep generator has new frequency compensation for the wide range it covers: 15 cycles to over 100,000 cycles.

The new model 0-6 scope uses 10 tubes in all, including 5" CR tube. Has improved amplifiers for better response useful to 2 megacycles. Tremendous sensitivity 64V RMS rec. inch horizontal — 99V RMS per inch vertical. Only Heathkit scopes have all the features.

New heavy-duty power transformer has 50% more laminations. It runs cool and has the lowest possible magnetic field. A complete electrostatic shield covers primary and other necessary windings and has lead brought out for proper grounding.

The new filter condenser has separate sections for the vertical and horizontal screen grids and prevents interaction between them. An improved intensity circuit provides almost double previous brilliance and better intensity modulation.

A new synchronization circuit allows the trace to be synchronized with either the positive or negative pulse, an important feature in observing the complex pulses encountered in television servicing.

Model 0-6..... Shipping Wt. 24 lbs.

\$3950

The magnetic alloy shield supplied for the CR tube is of new design and uses a special metal developed by Allegheny Ludlum for such applications.

The kit is complete, all tubes, cabinet, transformer, controls, grid screen, tube shield, etc. The instruction manual has complete step-by-step assembly and pictorials of every section. Compare it with all others and you will buy a Heathkit.

NEW INEXPENSIVE Heathkit ELECTRONIC SWITCH KIT

The companion piece to a scope — Feed two different signals into the switch, connect its output to a scope, and you can observe both signals — each as an individual trace. Gain of each input is easily set (gain A and gain B controls), the switching frequency is simple to adjust (coarse and fine frequency controls) and the traces can be superimposed for comparison or separated for individual study (position control).



Model 5-2 Shipping Wt. 11 lbs.

\$1950

Use the switch to see distortion, phase shift, clipping due to improper bias, both of the input and output traces of an amplifier, — as a square wave generator over limited range.

The kit is complete: all tubes, switches, cabinet, power transformer and all other parts, plus a clear detailed construction manual.

New MODEL V-4 A

Heathkit VTVM KIT

The new Heathkit Model V-4A VTVM Kit measures up to 30,000 Volts DC and 250 megacycles when used with accessory probes — think of it, all in one electronic instrument more useful than ever before. The AC Voltmeter is so flat and extended in its response (± 1 db from 20 cycles to 2 megacycles) that it eliminates the need for separate expensive AC VTVM's.

The new 200 microampere, $4\frac{1}{2}$ " streamline meter with quality Simpson movement (five times as sensitive as the commonly used 1 MA meter) has a shatter proof plastic meter face for maximum protection. Meter has all the desirable scales and indicates AC volts, DC volts, ohms, db (direct reading), and even has a special zero center marking for quick FM alignment.

There are six complete ranges for each function. Four functions give total of 24 ranges. The 3 volt range allows 33 1/3% of the scale for reading 1 volt, as against only 20% of the scale on the 5 volt types.

New 1/2% ceramic precision resistors are the most accurate commercial type available — you find the same make and quality in the finest laboratory equipment selling for thousands of dollars. The entire voltage divider decade uses these 1/2% resistors.

Both AC and DC voltmeter measurements use a push-pull electronic voltmeter circuit, and the meter circuit makes the meter burn-out proof. Electronic ohmmeter circuit measures resistance over the amazing range of 1/10 ohm to one billion ohms, all with internal 3 volt battery. Ohmmeter batteries mount on the chassis in snap-in mounting for easy replacement.

Voltage ranges are full scale — 3 Volts, 10 Volts, 30 Volts, 100 Volts, 300 Volts, 1000 Volts. Complete decading coverage without gaps.

The DC probe is isolated for dynamic measurements. Negligible circuit loading. Gets the accurate reading without disturbing the operation of the equipment under test. Kit comes complete: cabinet, transformer, Simpson meter, test leads, complete assembly and instruction manual.

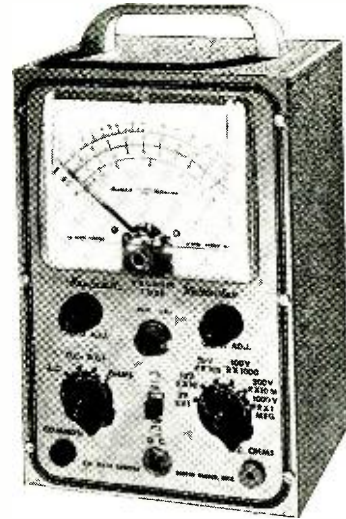

Model V-4A Shipping Wt. 8 lbs.

Note New Low Price

\$2350



\$550

No. 336 High Voltage Probe Kit..... Shipping Wt. 2 lbs.

Heathkit 30,000V DC PROBE KIT

A new 30,000 V DC Probe Kit to handle high voltages with safety. For TV service work and all other high voltage applications. Sleek looking — Two color molded plastic — Red body and guard — jet black handle. Comes with connector, cable, and PL55 type plug. Plugs into Heathkit VTVM so that 300V scale is conveniently multiplied by 100. Can be used with any standard 11 megohm VTVM.



Shipping Wt. 1 lb. \$550

Heathkit RF PROBE KIT

This RF Probe Kit comes complete with probe housing, crystal diode detector, connector, lead and plug and all other parts plus clear assembly instructions. Extends range of Heathkit VTVM to 250 Mc. $\pm 10\%$. Works on any 11 megohm input VTVM. Specify No. 309 RF Probe Kit.

SOLE AGENT
ROCKE INTERNATIONAL CORP.
33 E. 40th ST.
NEW YORK CITY 17
CABLE: 38248-H F.

The HEATH COMPANY

... BENTON HARBOR 20, MICHIGAN

NEW Heathkit TV ALIGNMENT GENERATOR KIT

Here is an excellent TV Alignment Generator designed to do TV service work quickly, easily, and properly. The model TS-2 when used in conjunction with an oscilloscope provides a means of correctly aligning television receivers.

The instrument provides a frequency modulated signal covering, in two bands, the range of 10 to 90 Mc. and 150 to 230 Mc. — thus ALL ALLOCATED TV CHANNELS AS WELL AS IF FREQUENCIES ARE COVERED.

An absorption type frequency marker covers from 20 to 75 Mc. in two ranges — therefore, you have a simple, convenient means of frequency checking of IF's, independent of oscillator calibration.

Sweep width is controlled from the front panel and covers a sweep deviation of 0-12 Mc. — all the sweep you could possibly need or want.

And still other excellent features are: Horizontal sweep voltage available at the front panel (and controlled with a phasing control) — both step and continuously variable attenuation for setting the output signal to the desired level — a convenient instrument stand-by position — vernier drive of both oscillator and marker tuning condensers — and blanking for establishing a single trace with base reference level. Make your work easier, save time, and repair with confidence — order your Heathkit TV Alignment Generator now!

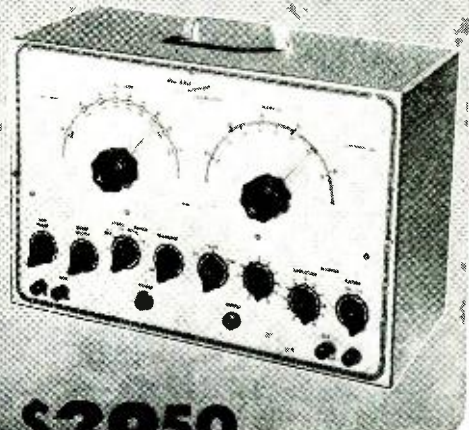

\$3950

Model TS-2
Shipping Wt. 20 lbs.

Heathkit SIGNAL GENERATOR KIT



Model SG-6
Shipping Wt. 7 lbs.

\$1950

The new Heathkit Signal Generator Kit has dozens of improvements. Covers the extended range of 160 Kc to 50 megacycles on fundamentals and up to 150 megacycles on useful calibrated harmonics; makes this Heathkit ideal as a marker oscillator for TV. Output level can be conveniently set by means of both step attenuator and continuously variable output controls. Instrument has new miniature HF tubes to easily handle the high frequencies covered.

Uses 6C4 master oscillator and 6C4 sine wave audio oscillator. The kit is transformer operated and a husky selenium rectifier is used in the power supply. All coils are precision wound and checked for calibration making only one adjustment necessary for all bands.

New sine wave audio oscillator provides internal modulation and is also available for external audio testing. Switch provided allows the oscillator to be modulated by an external audio oscillator for fidelity testing of receivers. Comes complete, all tubes, cabinet, test leads, every part. The instruction manual has step-by-step instructions and pictorials. It's easy and fun to build a Heathkit Model SG-6 Signal Generator.

Heathkit SIGNAL TRACER and UNIVERSAL TEST SPEAKER KIT

The popular Heathkit Signal Tracer has now been combined with a universal test speaker at no increase in price. The same high quality tracer follows signal from antenna to speaker — locates intermittents — finds defective parts quicker — saves valuable service time — gives greater income per service hour. Works equally well on broadcast, FM, or TV receivers. The test speaker has an assortment of switching ranges to match either push-pull or single output impedances. Also tests microphones, pickups and PA systems. Comes complete: cabinet, 110V 60 cycle power transformer, tubes, test probe, all necessary parts, and detailed instructions for assembly and use.



Model T-2
Shipping Wt. 7 lbs.

\$1950

Heathkit TUBE CHECKER KIT

Test your tubes the modern way — dynamically — the simplest, yet fastest and surest method — your Heathkit has a switch for each tube element and measures that element — no chance for open or shorted elements slipping by, all the advantages of the mutual conductance type without the slow cumbersome time consuming setups. Checks for opens, shorts, each element individually, filament and filament tap continuity, and emission.

This Tube Checker has all the features — beautiful 3 color BAD-?-GOOD meter — complete selection of voltages — roller chart listing hundreds of tubes including the new 9 pin miniatures — finest quality Centralab lever switches — high grade birch, counter-type cabinet — continuously variable line adjust control — every feature you need to sell tubes properly. The most modern type tube checker with complete protection against obsolescence. Uses only the best of parts — rugged oversize 110V 60 cycle power transformer, finest of Mallory and Centralab switches and controls, complete set of sockets for all type tubes with blank spare for future types. Fast action, gear driven roller chart quickly locates the setting for any type tube. Simplified switching cuts necessary testing time to a minimum and saves valuable service time. Simple method allows instant setup of new tube types without waiting for factory data. No matter what the arrangement of tube elements is, the Heathkit flexible switching method easily handles it. Order your Heathkit Tube Checker Kit today and see for yourself that Heath again saves you two-thirds and yet retains all the quality. Complete with instructions, all parts, and cabinet.

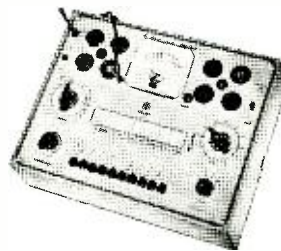

Model TC-1
Shipping Wt. 12 lbs.

\$2950

Heathkit CONDENSER CHECKER KIT

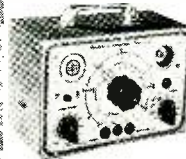

\$1950

Checks all types of condensers — paper, mica, ceramic, electrolytic. All condenser scales are direct reading and require no charts or multipliers. Covers range of .00001 MFD to 1000 MFD. A Condenser Checker that anyone can read. A leakage test and polarizing voltage for 20 to 500 V provided. Measures power factor of electrolytics between 0% and 50% and reads resistance from 100 ohms to 5 megohms. The magic eye indicator makes testing easy.

The kit is 110V 60 cycle transformer operated and comes complete with rectifier tube, magic eye tube, cabinet, calibrated panel and all other parts. Has clear detailed instructions for assembly and use.

Model C-2 Shipping Wt. 6 lbs.

NEW Heathkit HANDITESTER KIT

A precision portable volt-ohm-milliammeter. Uses only high quality parts — All precision 1/2% resistors, three deck switch for trouble-free mounting of parts, specially designed battery mounting bracket, smooth acting ohm adjust control, beautiful molded bakelite case, 400 microamp meter movement, etc. DC and AC voltage ranges 10-30, 300-1000-5000V. Ohms range 0-3000 and 0-300,000 Range Milliampers 0-10 Ma, 0-100 Ma. Easily assembled from complete instructions and pictorial diagrams.



Model M-1 Shipping Wt. 3 lbs.

\$1350

REPORT AGENT
ROCKE INTERNATIONAL CORP.
13 E. 40th ST.
NEW YORK CITY (10)

The HEATH COMPANY

... BENTON HARBOR 20, MICHIGAN

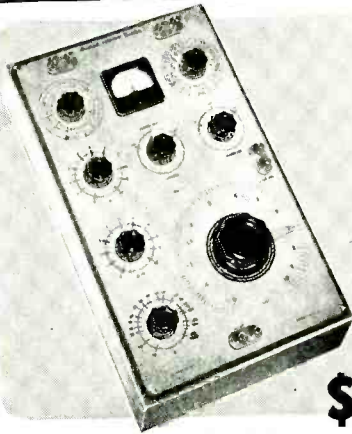

Model IB-1B Shipping Wt. 15 lbs.

NEW *Heathkit* IMPEDANCE BRIDGE KIT

This Impedance Bridge Kit is really a favorite with schools, industrial laboratories, and serious experimenters. An invaluable instrument for those doing electrical measurements work. Reads resistance from .01 Ohms to 10 megohms, capacitance from .00001 MFD to 100 MFD, inductance from 10 microhenries to 100 henries, dissipation factor from .002 to 1, and storage factor from 1 to 1000. And you don't have to worry about selecting the proper bridge circuit for the various measurements — the instrument automatically makes the correct circuit when you set up for taking the measurement you want. Bridge utilizes Wheatstone, Hay, Maxwell, and capacitance comparison circuits for the wide range and types of measurements possible. And it's self powered — has internal battery and General Radio 1000 cycle hummer. No external generator required — has provisions for external generator if measurements at other than 1000 cycles are desired.

Kit utilizes only highest quality parts, General Radio main calibrated control, General Radio hummer, Mallory ceramic switches, excellent 200 microamp zero center galvanometer, laboratory type binding posts with standard 3/4 inch centers, 1/2% precision ceramic-body type multiplier resistors, beautiful birch cabinet and ready calibrated panel. (Headphones not included.)

Take the guesswork out of electrical measurements — order your Heathkit Impedance Bridge Kit today — you'll like it.

\$6950

Heathkit LABORATORY RESISTANCE DECADE KIT

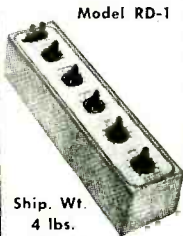

Model RD-1

An indispensable piece of laboratory equipment — the Heathkit Resistance Decade Kit gives you resistance settings from 1 to 99,999 ohms IN ONE OHM STEPS. For greatest accuracy, 1/2% precision ceramic-body type resistors and highest quality ceramic wafer switches are used.

Designed to match the impedance bridge above, the Resistance Decade Kit has a beautiful birch cabinet and attractive panel. It's easy to build, and comes complete with all parts and construction manual.

Ship. Wt. 4 lbs.

\$1950

NEW *Heathkit* SINE and SQUARE WAVE AUDIO GENERATOR KIT

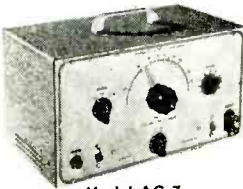

Model AG-7
Ship. Wt. 15 lbs.

We proudly present the NEW MODEL Sine and Square Wave Audio Generator Kit. Designed with versatility, usefulness, and dependability in mind, the AG-7 gives you the two most needed waveshapes right at your fingertips — the sine wave and the square wave.

The range switch and plainly calibrated frequency scale give rapid and easy frequency selection, and the output control permits setting the output to any desired level.

A high-low impedance switch sets the instrument for either high or low impedance output — on high to connect to high impedance load, and on low to work into a low impedance transformer with negligible DC resistance.

Coverage is from 20 to 20,000 cycles, and distortion is at a minimum — you can readily trust the output waveshape.

6 tubes, quality 4 gang tuning condenser, power transformer, metal cased filter condenser, 1/2% precision resistors in the frequency determining circuit, and all other parts come with the kit — plus a complete construction manual. A tremendous kit, and the price is truly low.

\$3450



ORDER BLANK

From _____

SHIP VIA

- Parcel Post
- Express
- Freight
- Best Way

Quantity	Item	Price	Quantity	Item	Price
	Heathkit Oscilloscope Kit — Model O-6			Heathkit R.F. Probe Kit — No. 309	
	Heathkit VTVM Kit — Model V-4A			Heathkit H.V. Probe Kit — No. 336	
	Heathkit FM Tuner Kit — FM-2			Heathkit R.F. Signal Gen. Kit — Model SG-6	
	Heathkit Broadcast Receiver Kit — Model BR-1			Heathkit Condenser Checker Kit — Model C-2	
	Heathkit Three Band Receiver Kit — Model AR-1			Heathkit Handitester Kit — Model M-1	
	Heathkit Amplifier Kit — Model A-4			Heathkit Power Supply Kit — Model PS-1	
	Heathkit Amplifier Kit — Model A-6 (or A-6A)			Heathkit Resistance Decade Kit — Model RD-1	
	Heathkit Tube Checker Kit — Model TC-1			Heathkit Impedance Bridge Kit — Model IB-1B	
	Heathkit Audio Generator Kit — Model AG-7				
	Heathkit Battery Eliminator Kit — Model BE-2				
	Heathkit Electronic Switch Kit — Model S-2				
	Heathkit T.V. Alignment Gen. Kit — TS-2				
	Heathkit Signal Tracer Kit — Model T-2				

On Parcel Post Orders, include postage for weight shown and insurance. (We insure all shipments.)

On Express Orders, do not include transportation charges — they will be collected by the Express Agency at time of delivery.

Enclosed find Check Money Order for _____

Please ship C.O.D. Postage enclosed for _____ lbs.

ALL PRICES SUBJECT TO CHANGE WITHOUT NOTICE

EXPORT AGENT
 ROCKE INTERNATIONAL CORP.
 13 E. 40th ST.
 NEW YORK CITY (10)
 CABLE: ARLAS-N.Y.

The HEATH COMPANY

... BENTON HARBOR 20, MICHIGAN

(and a.v.c. bias voltage) by approximately 60% cause the diode to cut off. This limiter action does not produce any apparent audio distortion with voice transmissions, but it does distort music noticeably. If the receiver is to be used strictly for voice communication the limiter may be wired in permanently. Where this audio distortion is not acceptable, an on-off switch may be installed, as indicated in the diagrams. This will allow normal reception, as in mobile service where the receiver is

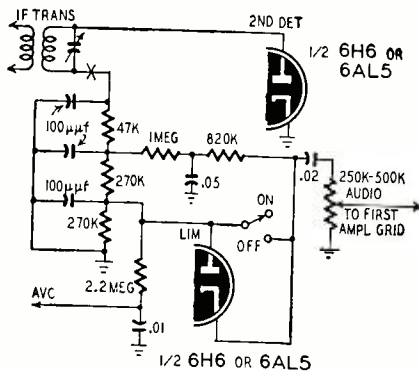

Fig. 3—The HQ-129X limiter circuit.

used both for shortwave and broadcast reception. Use short leads to connect the limiter switch because high stray capacitance will bypass the signal around the noise limiter diode and cause poor operation of the limiter.

The HQ-129X noise limiter is the favorite of many mobile amateurs. It does require a few more components, but it is excellent for removing high-level ignition noise. The circuit of this limiter appears in Fig. 3 while Fig. 4 indicates some common second detector circuits marked with an X to indicate where the limiter is inserted. The problem is simply to alter the connections between the second detector i.f. trans-

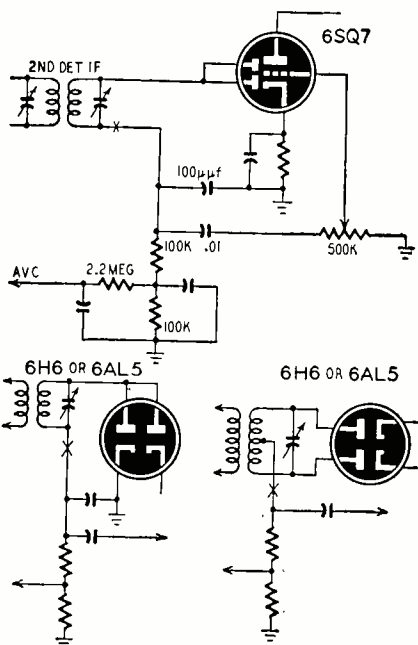

Fig. 4—Three common detector hookups. X marks the spot where the circuit is broken to connect the HQ-129X limiter.

former and the first audio grid. If this second detector uses a simple diode circuit then the chances are that only the ground-return lead of the i.f. transformer need be disconnected and re-wired. In any case, the a.v.c. return will have to be shifted to the new limiter resistance network. When the second detector i.f. transformer wiring is not otherwise changed, there is no need to realign this transformer. If the unused diode in the added tube is to be used for the second detector, then the second detector i.f. coil may require slight realignment, especially if long leads are used. The new tube should be mounted close to where the second detector is installed in the receiver.

The procedure for adding these noise limiters depends on the receiver. Most commercial receivers use diode detection with either a 6H6 or 6SQ7 tube or equivalent. Where a 6H6 is used for the second detector, the modifications for noise limiter action are few and simple. A 6SQ7 second detector which has cathode bias presents more of a problem. Usually another diode must be added to the circuit. If a dual diode tube, such as the 6AL5, is added, one-half may be used for the limiter and the other for the detector. The bias network in the cathode of the 6SQ7 may not be removed, as it supplies bias for the triode section of the tube.

The noise-limiter rectifier is across approximately 1 to 2 megohms of resistance, so its inverse resistance characteristic must be high. The 1N34 inverse resistance, compared with that of a vacuum tube, is too low for these circuits. We tried a 1N34 in the HQ-129X circuit. Limiting action did occur, but not enough to be useful.

Other noise problems

Limiters will not eliminate power-line hum, corona, or other sinusoidal QRM. Luckily, much interference is pulse-like and may be removed from the signal intelligence by a limiter. For non-mobile operation, antenna noise balancing circuits may be used to eliminate this noise. Such a circuit is shown by Fig. 5. The antenna coil has a balanced center-tapped ground, which effectively introduces two inputs into the receiver 180° out of phase. C1 is tuned for maximum radio signal, while C2, which connects to a noise pickup antenna, is tuned to lower the noise. When properly balanced, power-line buzz can be reduced nearly to zero without attenuating the desired signal excessively. In some cases an incorrect adjustment can result in balancing out the signal as well as the noise. The use of a good high antenna for signal reception will prevent this. This method of noise balancing requires readjustment of C2 for different signals and should be used only if a shielded coaxial lead and a high dipole antenna will not eliminate the noise condition.

Although a limiter does reduce noise, precautions to prevent radio noise from being generated are better. The lower

the noise into the receiver, the better the signal intelligence, even with the limiter in operation. In the home, a .01 to 0.1-µf, 600-volt capacitor will suppress noise from your electric razor and the wife's cake mixer. This capacitor can be of the paper variety and may be fused with a 1-ampere fuse for safety. Install the capacitor across the line in the outlet box at the noise-producing device; it is useless at the receiver.

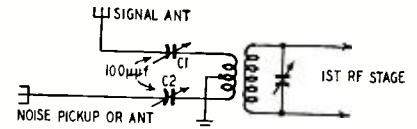

Fig. 5—A noise balancing antenna circuit such as this is useful for eliminating certain types of interference.

When a converter is added to an auto radio for short-wave reception, ignition noise will appear. Use of Auto-Lite resistor-type spark plugs will reduce the high levels of ignition noise in your receiver. These, plus your limiter, will eliminate ignition interference on short-wave bands. These spark plugs alone will not cure your own interference, but the improvement will be noticeable.

—end—

PUZZLING OSCILLATIONS IN VR TUBES

When a VR-type voltage regulator tube goes into oscillation, the technician usually looks for a capacitor (commonly about 0.1 µf) in the circuit to which regulated voltage is supplied. This capacitor, in parallel with the VR tube, and the limiting resistor R set up a relaxation oscillator circuit. Removing the capacitor, or sometimes lowering its value, cures the oscillation.

The gas tube voltage regulator can, and often does, oscillate without benefit of the capacitor. When the tube has not fired, it is passing no current through resistor R, and there is no voltage drop across this resistor. The tube therefore "sees" the full d.c. voltage (E) delivered by the power supply. If this voltage increases (or if resistance R is decreased), so that the tube just barely receives its full striking voltage, the tube will fire. Tube current (I) now

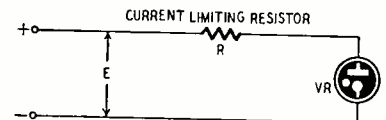

flows through R and produces a voltage drop across R equal to IR. The voltage across the tube itself quickly becomes E minus IR, which may be less than the extinguishing potential and the tube stops conducting. Once again, there is no drop across R, and the tube receives its full striking voltage and fires. The cycle then repeats itself.

This type of oscillation is most common when resistor R is varied or when the d.c. input voltage is varied. It always indicates that the resistance is incorrect for a given d.c. input voltage.

—Rufus P. Turner, K6AI

U. H. F. Mystery Meter

By H. W. SECOR

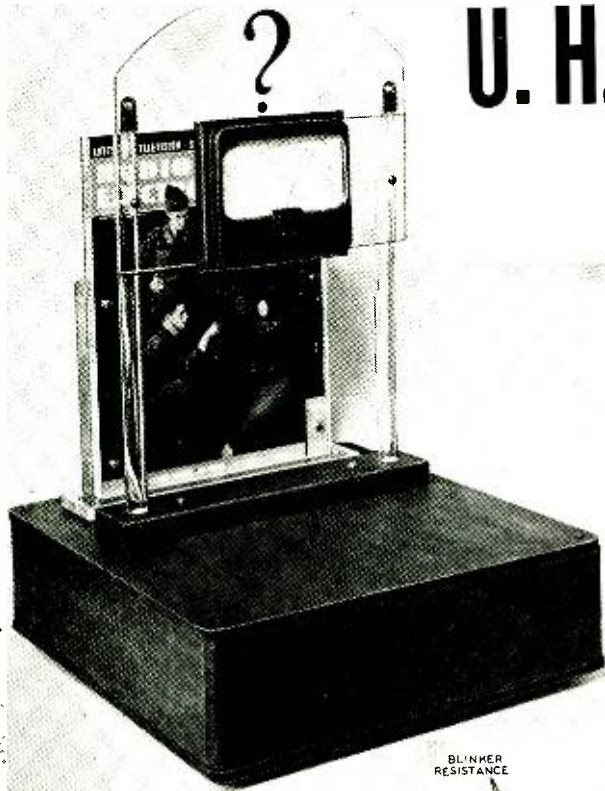

The mystery meter as it was used on display appears in the photo at left. Below is a photo that shows the arrangement of parts under the wooden platform.

THIS u.h.f. mystery meter display is an attention-getter developed by the author at the suggestion of the editor of this magazine for exhibition at the I.R.E. Radio Show this spring. It has a meter mounted in a clear plexiglas panel in front of a copy of RADIO-ELECTRONICS. The meter needle swings back and forth, but there is no apparent energizing source of connection to the meter.

Besides being interesting as a "stopper" for customers passing a shop window, it could have applications as a remote-control device, and could be made into a small 420-mc transmitter by increasing the plate voltage and providing a suitable antenna.

The meter (a 0-to-50 d.c. microammeter) operates because of the electromagnetic field set up by a loop or coil hidden in the magazine. A germanium diode concealed in the meter rectifies the r.f. Two plexiglas plates rigidly mounted on top of the cabinet support the magazine. The 4-inch diameter single-turn loop of No. 10 wire is mounted in a space cut out of the centers of the pages of the magazine. The loop is fed high-frequency current from an oscillator hidden in the cabinet, through a piece of 300-ohm ribbon line (television lead-in) about 1 foot long. Any short length of this twin conductor may be used for different designs of the display. The ribbon passes through a slot cut in the top of the wood cabinet and the piece of plexiglas on which the magazine is supported. This is not visible to the observer.

The oscillator

The exciter for this display is a self-rectifying u.h.f. oscillator, using a 6J6

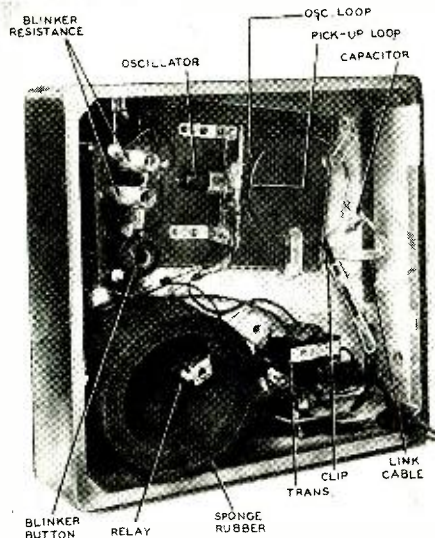

tube. As Fig. 1 shows, a transformer supplies the heater current to the tube, and the cathode (B-minus) lead is taken from the secondary center tap. The B-plus lead goes to the opposite side of the a.c. line.

The heater circuit and also the B-plus feed wire are supplied with r.f. chokes.

The heater-lead chokes have 8 turns of No. 26 enameled copper wire, wound closely on 1/4-inch diameter paraffined wood rods. Connect these r.f. chokes close to the tube socket terminals. The r.f. choke in the B-plus feed wire has 35 turns of No. 26 enameled wire, wound closely on a 1/4-inch diameter waxed wood rod. (Polystyrene is preferable.) The choke connects to a clip which fastens to the 1-turn plate coil. Since this is an a.c.-d.c. circuit, with one side attached to the electric-light line, it should be boxed carefully as shown in the photo, for safety. This is especially important in a window dis-

play—which may be handled by unskilled persons in close proximity to grounded objects such as steel frames of plate-glass windows. Such precaution should not be neglected in any case.

Keep all connections between the terminals on the base of the socket and the oscillator loop and tuning capacitor *very short*. Use No. 14 or 16 copper wire, with all joints soldered.

The oscillator loop is bent to a 4-inch diameter from a piece of No. 10 copper wire. The 3-30- μ f tuning capacitor (ceramic) is connected close to one end of the loop, as is the 4,700-ohm grid-leak resistor. If the tube refuses to oscillate (check with pilot-lamp test loop) try other resistor values. Also try adjusting the B-plus clip at different positions around the loop.

With the adjustable 3-30- μ f capacitor in the loop circuit adjusted about halfway in, the circuit oscillates at about 400 mc, as checked on Lecher wires.

The link circuit

Because the oscillator and its loop and capacitor would not fit inside the magazine, we used a link circuit as shown in Fig. 1. The two 4-inch diameter loops of No. 10 copper wire at each end of the link circuit are connected by a piece of 300-ohm ribbon about one foot long. A 3-30- μ f tuning capacitor tunes the pickup loop which is directly over the oscillator loop and separated from it by a piece of 1/2-inch plexiglas.

A neon lamp does not work well at these high frequencies, so a 4-inch diameter test loop was made with a 60-ma, 2-volt (pink bead) pilot lamp connected in series with the loop and a 3-30- μ f adjustable capacitor. Once the oscillator is set up and operating, the test lamp loop is brought close to it and the lamp will glow if the oscillator is working.

A lamp indicator could be used in place of a meter, where cost is an item, but the meter is much more interesting to watch. A 1N34 germanium crystal rectifier is connected across the meter terminals, together with a 50- μ f bypass capacitor, as Fig. 2 shows. A 3-30- μ f ceramic tuning capacitor is connected in the loop circuit. The meter pickup loop is 4 inches in diameter, made of No. 10 copper wire. Solder all connections in the meter unit. Use an insulated tuning rod to adjust the capacitors in these u.h.f. circuits. Adjust the meter loop capacitor for maximum deflection at a given distance.

The loop for the meter circuit, with its capacitor and rectifier, etc., are hidden in a wafer made of 3/8-inch thick bakelite, cut slightly larger than the

base of the meter. (See Fig. 2.) A piece of $\frac{1}{32}$ -inch black fiber is placed at the rear of the wafer to hide the "works." The meter screws hold the whole assembly against the plexiglass panel, a hole being cut in the panel to admit the

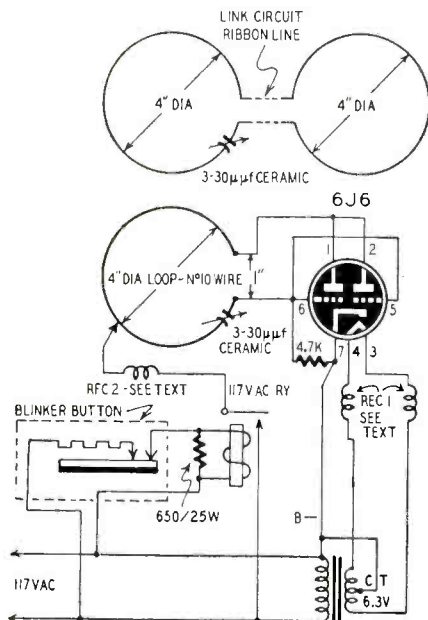

Fig. 1—Circuit of the mystery meter.

barrel of the meter. A false cover of thin bakelite fits over the barrel of the meter, to hide the wire connections to the posts of the meter.

A relay interrupter

The meter needle is made to swing back and forth at intervals of about one-half second, by means of a blinker-button. The button is in series with a 117-volt a.c. relay. (See Fig. 1.) The secondary terminals of the relay interrupt the B-plus feed to the oscillator loop, as Fig. 1 shows. The blinker-button was tried at first with a 15-watt, 117-volt lamp, but in the final model the light bulb was replaced by a 650-ohm, 25-watt resistor. We used three resistors in series for lack of a single unit of the right value. The relay is mounted in a sound-deadening rubber chamber.

Materials for Mystery Meter

Resistors: 1—4,700 ohms, $\frac{1}{2}$ watt; 1—650 ohms, 25 watts.
Capacitors: 3—3-30 μ if, variable, ceramic; 1—50 μ if, ceramic.
Miscellaneous: 1—6J6 tube and socket; 1—117-volt a. c. relay; 1—blinker-button; 1—6.3-volt filament transformer; 1—0-50- μ a meter; hookup wire, assorted hardware, plexiglass.

—end—

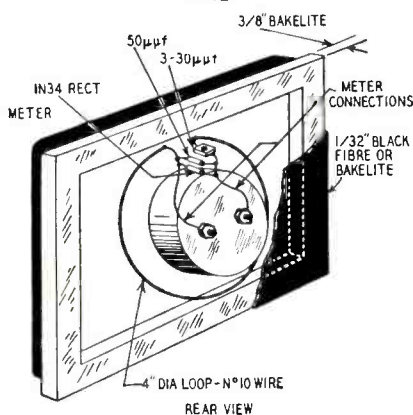
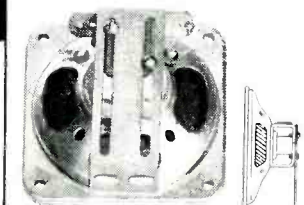

Fig. 2—The meter and pickup circuit.

Attention ALL SERVICEMEN
 announcing the entirely **NEW**
Permoflux
"CHAMPION" SPEAKERS

**GREATER PROFITS!
 PROMPT DELIVERY!
 TOP QUALITY!**

- AVAILABLE IN ALL THESE SIZES:**
- 2 1/4" Sq., 4" Sq., 4" x 6" Elip., 5" Round, 5" P.C., 5" x 7" Elip., 6" P.C., 6" Auto, 6" x 9" Auto, 7" Auto, 8" P.C., 10" Round, 12" Round



Model C4A \$5.00

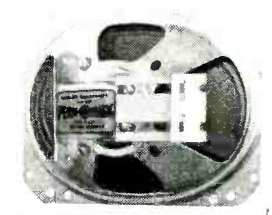

Model C46A \$5.50

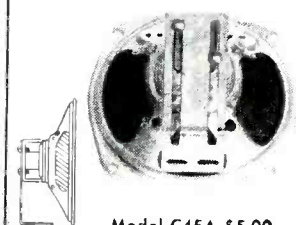

Model C45A \$5.00

From one of America's leading manufacturers of quality speakers for original equipment comes the announcement of the new Permoflux line of "Champion" permanent magnetic speakers.

"Champion" speakers are equipped with unique universal mounting brackets and tapped yokes for ease of installation in any position. Mounting holes and transformer mountings are standard RTMA. Voice coil impedance 3.2 ohm on all "Champion" speakers.

For greater profits . . . quick delivery . . . top quality, order your Permoflux "Champion" speakers from your distributor today.



Inquire about Permoflux's Complete Royal Blue Line 6" to 12" Speakers and send for the new attractively illustrated catalog "Permoflux Royal Lines No. J202."

TRADE MARK
PERMOFLUX
 "SOUND IN DESIGN"
PERMOFLUX CORPORATION
 4912 W. GRAND AVE., CHICAGO 39, U.S.A. • 263 S. VENDUGO RD., GLENDALE 5, CALIF.
 Canadian Licensee . . . Campbell Mfg. Company, Toronto, Canada

Automatic Porch Light Guards House at Night

By JOHN T. FRYE

TV DX
is our business!

from BOSTON
from PHOENIX
from SEATTLE
from NEW YORK
from EVERYWHERE!

come unsolicited enthusiastic letters by dealers, installers and users reporting sensational results on the new

GONSET LOW CHANNEL RADARRAY

"We have tried them all and your antenna outperforms them all."

There are good, sound technical reasons for the superior performance of the

GONSET LOW CHANNEL RADARRAY

Users are interested in results, and it is the high gain and high front-to-back ratio on all the low channels that is making converts of confirmed "antenna cynics." For unexcelled performance on all the low channels (2 through 6) you need but one antenna, if it is a

GONSET LOW CHANNEL RADARRAY

Engineered and manufactured by pioneer fringe area antenna specialists. Write today for brochure describing this and other fringe area antenna products, such as the **GONSET HIGH CHANNEL RADARRAY** and **GONSET LINE** (ultra low loss open-wire line).



GONSET CO., BURBANK, CALIF.

LET US PUT THIS MAMMOTH NEW 1951 19 1/2-INCH Picture

MIDWEST TELEVISION
In Your Home on
30 DAYS TRIAL

Don't buy any radio or television receiver until you've seen the new 1951 Midwest Line — it's the finest in 31 years!

EASY TERMS

FACTORY-TO-YOU

MIDWEST RADIO & TELEVISION CORP.
Dept. 38N, 909 Broadway, Cincinnati 2, Ohio

NAME _____
ADDRESS _____
CITY _____ ZONE _____ STATE _____

SEND THIS COUPON ON 1¢ POST CARD FOR NEW 1951 FREE 4 COLOR MIDWEST CATALOG

ONE night last winter we answered our doorbell, and an insane man walked in. Before we could summon the police, the 200-pound stranger had torn a heavily bound book to pieces, kicked a glass-topped coffee table into a console radio, and, in general, scared all of us half out of our wits.

Inspired by the vivid memory of two husky officers wrestling the poor demented fellow all over our living room while trying to place handcuffs on him, we worked out a device to prevent a recurrence of this hair-raising experience. In brief, it is an electrically operated switch that turns on the porch light the instant the doorbell button is pushed and holds it on for a predetermined length of time. At the expiration of that time, the light is automatically turned off.

The gadget is shown in the photo and drawing. The portion of the diagram to the left of points A and B is an ordinary doorbell circuit, consisting of a step-down transformer, a pushbutton switch, and a doorbell, or chimes. The control circuit is inside the dashed lines; it consists of a 100-ma selenium rectifier, a 1,000- μ f, 25-volt electrolytic capacitor, and a sensitive, high-resistance, d.c. relay.

The rectifier develops a d.c. voltage which charges the capacitor during the time that the push-button is closed. This charge cannot flow backward through the rectifier after the push-button has been released, so the capacitor discharges through the winding of the relay. This discharge current closes the contacts of the relay. These contacts are connected in parallel with the usual porch light switch so the light is turned on. The contacts remain closed until the slowly diminishing discharge current reaches the drop-out point of the relay—a point considerably below the current level required to close the contacts. When the current falls to this drop-out value, the points open and the light is extinguished.

The actual time that the points remain closed depends upon the rectified voltage, value of the capacitor, the pull-in and drop-out current requirements of the relay, and the resistance of the relay winding. When the components shown in the diagram are connected across the 18-volt winding of a standard bell transformer, the points remain closed for almost exactly a minute.

The capacitor shown is a dual 500-

μ f, 25-volt unit with the two sections in parallel. The relay shown is a sensitive type manufactured by the RBM Company of Logansport, Indiana, and carries their part number 98341-9022. It has a 15,000-ohm coil and is designed to pull in at 0.98 ma and to drop out at 0.35 ma. However, any sensitive high-resistance relay can be used. For example, a relay with a 750-ohm winding would stay closed for only 15 seconds when connected directly across the capacitor; but when a 5,000-ohm resistor was connected in series with the relay coil across the capacitor the contacts were closed for 45 seconds.

Any relay that has a very low current requirement can be used with a series resistor to lengthen the time that the points will remain closed. If you were dealing with precisely known and stable voltage, capacitance, and resistance, this actual time could be calculated by employing the time-constant formula; but since these elements are subject to considerable variation in this case, it is quicker and simpler just to experiment with various resistance values until you have the particular time-delay you want.

To guard the sensitive relay against moisture and to make sure the device cannot become a fire hazard, it is constructed on the lid of a paint can 5 inches tall and 4 1/2 inches in diameter. The two leads that go to the bell transformer and the two that come from the relay contacts are all brought out

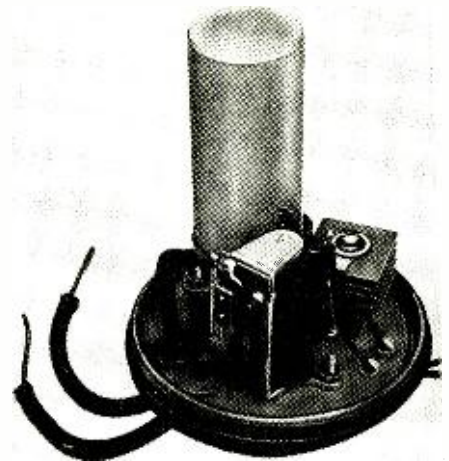
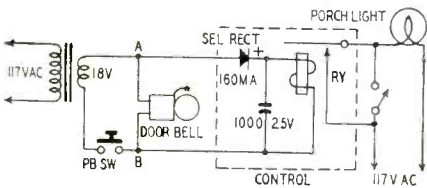

Photo of the porch light control. It is assembled on the lid of a paint can, then inserted into the can and sealed.

RADIO-ELECTRONICS for

through rubber grommets in the lid. Rubber-to-metal cement is used to seal these openings tightly against moisture. When the lid bearing the gadget is pressed tightly into its can for an airtight seal. Two brass angle pieces soldered to the sides of the can provide a means of mounting it.

This courtesy porch light may startle your guests the first time it flashes on as soon as they touch the push-button, but you will find they like the idea.



Circuit of the automatic porch light.

You will find yourself using the light, too. When you and the family come home late at night, you do not have to fumble around with your key on a dark porch. You simply punch the doorbell button and flood your porch with light.

Materials for Automatic Porch Light

1—selenium rectifier, 100 ma; 1—electrolytic capacitor, 1,000 uf, 25 volts; 1—relay, s.p.s.t. normally open contacts.

—end—

ARC SUPPRESSOR

Special precautions must be taken to suppress arcing at the contacts of small relays which handle direct current into a highly inductive load. The arcing, caused by a high induced voltage which

is developed when the circuit is broken, pits the contacts and shortens the useful life of the relay. The usual suppressor circuit consists of a resistor and capacitor in series across the contacts. The capacitor absorbs the induced e.m.f. and the resistor retards the flow of discharge current from the capacitor when the contacts close.

In many cases, the inductive load stores up more energy than can be absorbed by the capacitor, so there is sufficient energy left to arc across the contacts. Increasing the size of the capacitor may cause the contacts to weld together.

We find that these difficulties can be overcome by connecting several neon lamps in series across the capacitor as shown in the drawing. R and C are components of the standard arc suppressor. The sum of the ignition voltages of the individual lamps—without any external resistance—should be greater than the load voltage.

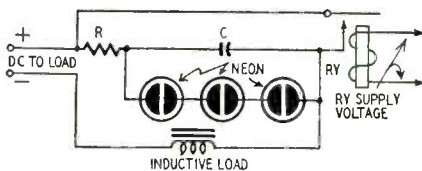

With this circuit, the lamps ignite and shunt the high self-induced voltage around the capacitor and contacts. The capacitor absorbs the surge energy until the voltage builds up enough to break down the lamps.—Harry Peach

THE WORLD'S LEADING TWIN LEAD TELEVISION LIGHTNING ARRESTER

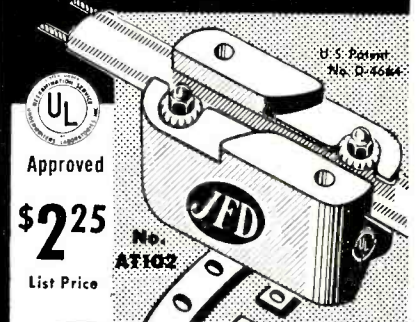

completely waterproof

JFD SAFE TV GUARD

Protects television sets against lightning and static charges. Simple to install everywhere and anywhere... no stripping, cutting or spreading of wires. More than 500,000 in use today!

See your jobber or write to —

JFD MANUFACTURING CO., INC.
8101-E 16th Ave., Brooklyn 4, New York
FIRST in Television Antennas and Accessories

FREE! BOOK OF 150 PICTURE PATTERNS & RADIO-TV DIAGRAMS Quick Reference TV Servicing Book Yours Free Just For Examining Coyne's New 5-Volume Set **APPLIED PRACTICAL RADIO-TELEVISION**



If you want to "go places" in Television and Radio Servicing today, COYNE'S new 5-volume set, "APPLIED PRACTICAL RADIO-TELEVISION", can help you. It is the most complete, up-to-date set of reference books in America, giving you the practical working knowledge that brings big money. 1500 jam-packed pages full of latest facts on television and radio—5000 subjects, 1000 illustrations and diagrams. Complete Section on COLOR TV with 1951 data on color adapters, converters and new UHF channels. Shows how to install, service, shoot trouble, align all types of radio and television sets. "Break-down" photos help you understand quicker. Use this set free for 7 days—get FREE book of 150 Radio-TV Picture Patterns and Diagrams for examining set. See sensational offer below.

FREE BOOK OF 150 TV-RADIO PATTERNS AND DIAGRAMS. ACT NOW!

Here's a sensational "get acquainted" offer IF YOU ACT AT ONCE, a brand new TV & Radio servicing book, "150 Picture Patterns and Radio-TV Diagrams Explained" is yours FREE. Shows actual TV picture tube patterns and wave forms as well as Radio and TV set Diagrams with clear explanations of what they mean and how to analyze and service the trouble faster. NOW YOU CAN GET A COPY ABSOLUTELY FREE just for asking to examine COYNE'S great 5-volume set APPLIED PRACTICAL RADIO-TELEVISION for 7 days. This offer is limited—mail coupon NOW.

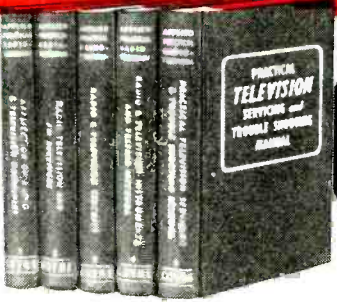

ON 7 DAYS' FREE TRIAL!

OFFER LIMITED—SEND COUPON TODAY!

Mail coupon for 7 days' FREE TRIAL on COYNE'S 5-volume set. I'll include the book of RADIO-TELEVISION PATTERNS & DIAGRAMS. If you keep the set you pay \$5.00 after 7 days trial and \$4.00 a month until \$16.50 plus postage is paid. (Cash price \$15.00). If not 100% satisfied with the set send it back and you OWE NOTHING, EITHER WAY, HOWEVER. THE BOOK OF 150 RADIO-TV PATTERNS AND DIAGRAMS IS YOURS FREE TO KEEP. Coupon is just a request to see the set and get the FREE Radio-TV Servicing book. This sensational offer is limited—SEND THE COUPON NOW.

SEND NO MONEY • MAIL COUPON NOW!

COYNE ELECTRICAL & TELEVISION-RADIO SCHOOL, Dept. 61-T1, 500 S. Paulina St., Chicago 12, Ill.

O.K.! Rush "APPLIED PRACTICAL RADIO-TELEVISION" for 7 days' FREE TRIAL per offer above, include copy of Patterns and Diagrams book as my FREE Gift for examining the set.

NAME Age

ADDRESS

CITY ZONE STATE

Check here if you want set sent C.O.D. You pay postman \$15.00 on delivery. Same money-back guarantee of satisfaction.

COYNE ELECTRICAL AND TELEVISION-RADIO SCHOOL
500 SO PAULINA ST • DEPT 61-TL • CHICAGO 12, ILL

**Build
15 RADIOS AT HOME**
With the New Improved 1951
Progressive Radio "EDU-KIT"
ONLY \$0.95

**FREE TOOLS
WITH KIT**
ABSOLUTELY NO
KNOWLEDGE OF
RADIO
NECESSARY
NO
ADDITIONAL
PARTS
NEEDED
EXCELLENT
BACKGROUND
FOR TELEVISION



WHAT THE PROGRESSIVE RADIO "EDU-KIT" OFFERS YOU

The Progressive Radio "Edu-Kit" offers you a home study course at a rock bottom price. Our Kit is designed to train you as a Technician, with the basic facts of Radio Theory and Construction Practice expressed simply and clearly. You will gain a knowledge of basic Radio Principles involved in Radio Reception, Radio Transmission and Audio Amplification. You will learn how to identify Radio Symbols and Diagrams; how to build radios, using regular radio circuit schematics; how to mount various radio parts; how to wire and solder in a professional manner. You will learn how to operate Receivers, Transmitters, and Audio Amplifiers. You will learn how to service and repair radio sets. In brief, you will receive a basic education in Radio exactly like the kind you would expect to receive in a Radio Course costing several hundred dollars.

THE KIT FOR EVERYONE

The Progressive Radio "Edu-Kit" was specifically prepared for any person who has the desire to learn Radio. The Kit has been used successfully by young and old in all parts of the world. It is not necessary that you have even the slightest background in science or radio.

The Progressive Radio "Edu-Kit" is used by many Radio Schools and Clubs in this country and abroad. It is used by the Veterans Administration for Vocational Guidance and Training.

The Progressive Radio "Edu-Kit" requires no instructor. All instructions are included. All parts are individually packaged, and identified by name, photograph and diagram. Every step involved in building these sets is carefully explained. You cannot make a mistake.

PROGRESSIVE TEACHING METHOD

The Progressive Radio "Edu-Kit" comes complete with instructions. These instructions are arranged in a clear, simple and progressive manner. The theory of Radio Transmission, Radio Reception and Audio Amplification is clearly explained. Every part is identified by photograph and diagram; you will learn the function and theory of every part used.

The Progressive Radio "Edu-Kit" uses the principle of "Learn By Doing." Therefore you will build radios to illustrate the principles which you learn. These radios are designed in a modern manner, according to the best principles of present-day educational practice. You begin building a simple radio. The next set that you build is slightly more advanced. Gradually, in a progressive manner, you will find yourself constructing still more advanced radio sets, and doing work like a professional Radio Technician. Altogether you will build fifteen radios, including Receivers, Amplifiers and Transmitters.

THE PROGRESSIVE RADIO "EDU-KIT" IS COMPLETE

You will receive every part necessary to build 15 different radio sets. This includes tubes, tube sockets, variable condensers, electrolytic condensers, mica condensers, paper condensers, resistors, tie strips, coils, tubing, hardware, etc. Every part that you need is included. In addition, these parts are individually boxed, so that you can easily identify every item.

TROUBLE-SHOOTING LESSONS

Trouble-shooting and servicing lessons are included. You will be taught to recognize and repair troubles. While you are learning in this practical way, you will be able to do many a repair job for your neighbors and charge fees which will far exceed the cost of the Kit. Here is an opportunity for you to learn radio and have others pay for it.

FREE EXTRAS IN 1951

- ELECTRICAL AND RADIO TESTER
- ELECTRICAL SOLDERING GUIDE
- BOOK ON TELEVISION
- RADIO TROUBLE-SHOOTING GUIDE
- MEMBERSHIP IN RADIO TELEVISION CLUB
- CONSULTATION SERVICE
- QUIZZES

Order your Progressive Radio "EDU-KIT" Today, or send for further information. Postage prepaid on cash orders. C.O.D. orders accepted in U.S.A.

**PROGRESSIVE
ELECTRONICS CO.**

497 UNION AVE.

DEPT. RE-48

BROOKLYN 11, N. Y.

(See advertising index for other advertisement of Progressive Electronics Co.)

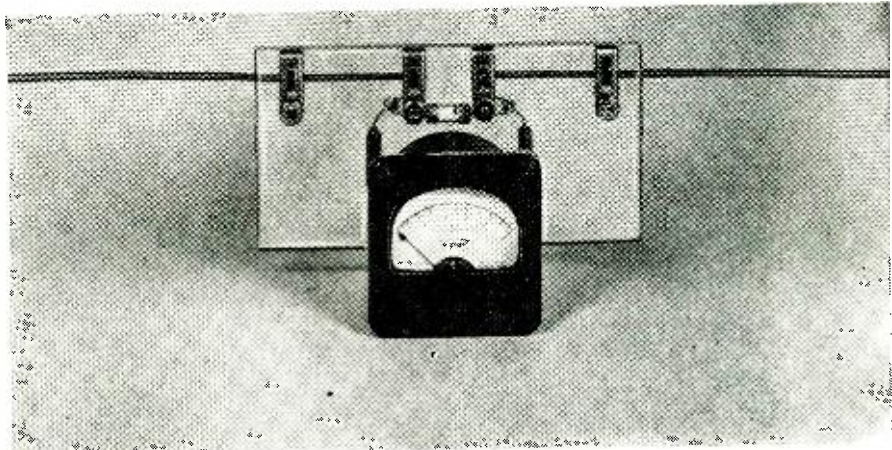

The panel of the v.h.f. field-strength meter. The panel is clear polystyrene.

Field Strength Meter Covers V.H.F. Ranges

By HARDIN G. STRATMAN

TUNING in the final stage of many high-frequency transmitters is often so sluggish and broad that it is almost impossible to check antenna tuning and loading by reading a meter in the plate or grid circuit. The same thing occasionally occurs in low-frequency transmitters because of mismatch or overcoupling. Considerable time can be saved and much better results obtained if tuning and loading adjustments are based on readings taken with some sort of field-strength meter.

The construction of a simple field-strength meter for use in the 150-160-mc police and taxi bands is shown in the diagram and photo. All components are mounted on a 3 x 6 x 1/8-inch panel cut from polystyrene or similar insulating material. Two 1/4-inch holes—spaced to fit over the meter terminals—were drilled approximately 1/2 inch in from one of the long sides of the panel. Four holes large enough to pass 6-32 screws were drilled on a line parallel to and 1 inch in from the opposite side. The holes are 1/2 and 2 1/2 inches in from each end.

Mount four Fahnestock clips on the rear of the panel with soldering lugs under the screws holding the innermost clips. The meter mounts in front of the panel with its terminals projecting at the rear. A soldering lug should be placed over each terminal before screwing down the nuts which hold it to the panel.

Solder a 1N34 crystal diode between the innermost clips and an Ohmite Z-144 r.f. choke between these clips and the meter terminals. Bypass the meter with a 100-µf ceramic capacitor.

To complete the unit, cut two pieces of heavy bus bar approximately 1/4 wavelength long at the operating frequency. Pass these through the clips from the opposite ends. Make sure that they do not touch in the center.

When in use, the instrument may be held by a helper or suspended parallel to and approximately 3 feet from the transmitting antenna. Adjust the final tuning and antenna controls for maximum reading on the meter. With this setup, a 5-watt transmitter in the 150-160-mc band will deflect a 1-ma meter to full scale. After tuning up a 3-5 watt mobile transmitter by this method, reliable reception was obtained over a distance of 7 to 10 miles from the transmitter, even over hilly terrain.

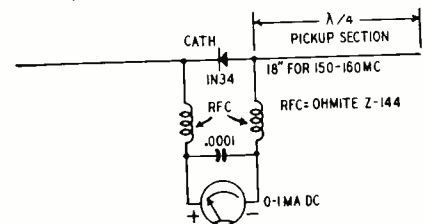

A diagram of a field-strength meter suitable for police and taxi bands.

The meter can be used to make comparative measurements on the strengths of two or more transmitters, in the same band, and to plot directivity patterns of antennas. The antenna sections should be approximately 1/4 wavelength at the operating frequency. If the frequency is far removed from 155 mc, the Z-144 r.f. chokes should be replaced with chokes suitable for use at the operating frequency.

—end—

TV LINEARITY CHECKER

This low-cost TV linearity checker produces a grid of horizontal and vertical lines on a screen of a TV set. The service technician adjusts the set's linearity controls so the lines are evenly spaced across the face of the tube.

The 6J5 is a blocking oscillator operating at 540 c.p.s. to produce 9 horizontal lines on the screen. Its frequency is determined by the characteristics of transformer T and the setting of the 10-megohm variable grid resistor. Transformer T is a push-pull audio output transformer (Stancor A-3857) having a plate-to-plate impedance of 25,000 ohms. The secondary is not used.

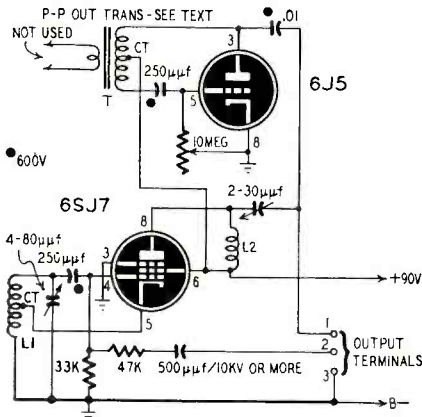

The 12 vertical lines are generated by the 6SJ7—an electron-coupled oscillator operating at 189 kc. L1 and L2 are 10-mh r.f. chokes (National R-100). The former is tapped between the second and third pies.

To operate, connect terminal 1 to the signal lead of the picture tube and terminal 3 to the chassis of the TV set. Adjust the 80-µf trimmer and 10-megohm resistor for 12 vertical and 9 horizontal lines, respectively. If the set and generator do not stay in sync, connect terminal 2 to the high-voltage terminal on the picture tube. Use standard high-voltage cable for this connection. Adjust the 30-µf trimmer for uniform brightness of the bars. Replace the 6J5 with one having lower gas content if the horizontal bars are weak or do not appear.

The designers of this circuit, Precision Apparatus Co., state that the instrument can be constructed for approximately \$7.00. They suggest that the constructor try using this unit to modulate a high-frequency r.f. generator by using a vacuum-tube or crystal diode mixer. Some constructors may elaborate on this basic circuit by connecting cathode followers in series with the output leads of each oscillator. These will minimize pulling, by isolating the oscillators from each other and from the external load.

A linearity checker such as this is practically an essential to the service technician these days because test pattern broadcasts are becoming extremely rare. With this instrument an accurate linearity adjustment can be made at any time.

—end—

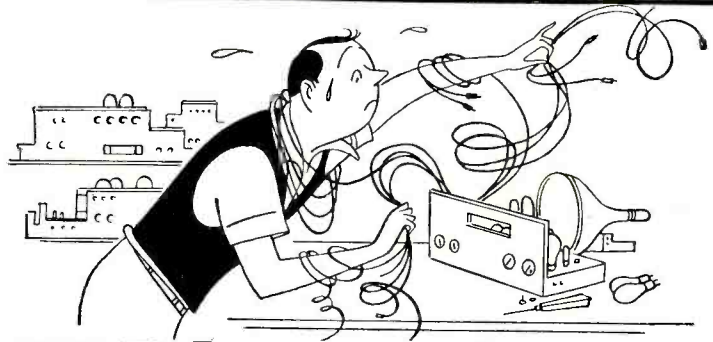

HELP! HELP! HELP!

Let John F. Rider help you untangle your servicing problems. RIDER MANUALS AND BOOKS have guided tens of thousands of servicemen on to better servicing and greater profits. They can be your "good right hand," too! Order from your Jobber today!

RIDER MANUALS

Now, more than ever, it is urgent that you have at your fingertips the priceless servicing data that can be found ONLY in RIDER MANUALS.

Rider TV Manual Vol. 6



ACCURATE . . . AUTHENTIC . . . FACTORY-AUTHORIZED TV servicing information DIRECT from 66 MANUFACTURERS. Big 12" x 15" page size, and all pages filed in place. Large, easy-to-read diagrams. Everything you need to speed servicing and satisfy your customers.

Exclusive Features:

- ALL TV production runs and changes from August, 1950 through January, 1951.
- Circuit action descriptions.
- Unpacking and installation material.
- Signal waveforms for troubleshooting.
- COMPLETE alignment data.
- COMPLETE parts list.
- Circuit changes.

Equivalent of 2320 pages (8½"x11") plus Cumulative Index Volumes 1 through 6 . . . \$24.00. With all 6 RIDER MANUALS you will own the world's greatest compilation of TV servicing information. SEE YOUR JOBBER TODAY!

Now Available! RIDER MANUAL Vol. XXI



FACTORY-AUTHORIZED servicing material from 61 manufacturers . . . AM—FM—Auto Radios—Record Changers—Disc and Tape Recorders. Coverage from December, 1949 through October, 1950. 1,648 pages PLUS Cumulative Index Volumes XVI through XXI . . . \$21.00

Television Manual Volume 6 (Plus Index)	\$24.00
Television Manual Volume 5 (Plus Index)	24.00
Television Manual Volume 4 (Plus "How It Works" Book and Index)	24.00
Television Manual Volume 3 (Plus "How It Works" Book and Index)	24.00
Television Manual Volume 2—In new, larger base size 12" x 15". (Plus "How It Works" Book and Index)	24.00
Television Manual Volume 1 (Plus "How It Works" Book and Index)	19.80
Volume XXI	21.00
Volume XX	21.00
Volume XIX	22.50
Volume XVIII	22.50
Volume XVII	19.80
Volume XVI	9.90
Volume XV	22.50
Volume XIV to VII (each volume)	19.80
Volume VI	15.00
Abridged Manuals I to V (one volume)	19.80
Master Index, Covering Manuals Vol. I to XV	1.50
PA Equipment Manual, Volume I.	18.00

RIDER BOOKS

Practical books, written by men with actual firing line experience . . . help you increase your knowledge . . . save you time and money.

BEAT THE TUBE SHORTAGE



RECEIVING TUBE SUBSTITUTION GUIDE BOOK
by H. A. Middleton
For TV-AM-FM Receivers and Allied Equipment

This amazing book shows you how to keep radio and TV sets working even though exact tube replacements are unavailable. 2500 radio and television tube substitutions listed, TV receiver filament wiring; heater substitution wiring instructions; tube types classified by functions . . . plus other important data you must have in order to keep receivers going. 224 pages, 8½"x11" durable paper cover . . . Only \$2.40

ENCYCLOPEDIA ON CATHODE-RAY OSCILLOSCOPES AND THEIR USES

by John F. Rider and Seymour D. Uslan



This is the ONLY book that so fully describes the oscilloscope . . . its application in servicing, engineering, research. It contains thousands of time-saving and work-saving references, charts, waveforms, etc. More than 70 different models are described with specifications and wiring diagrams. 992 pages, 8½" x 11", 3000 illustrations. 22 chapters, completely indexed . . . Only \$9.00

TV INSTALLATION TECHNIQUES

by Samuel L. Marshall



Here are facts you should know about wind surfaces, mounting requirements, etc. Here is accurate data on receiver adjustment in the home. Here are municipal regulations in all major TV areas. Here is complete information on mechanical and electrical considerations. 330 pages, 5½" x 8½", 270 illustrations. Cloth bound . . . Only \$3.60

OTHER BOOKS FOR THE SERVICEMAN

TV Master Antenna Systems	\$5.00
TV and Other Receiving Antennas	\$6.00
Radio Operator's License Q & A Manual, 2nd Edition	\$6.60
The Business Helper	\$2.00
FM Transmission and Reception	\$3.60
TV Picture Projection & Enlargement	\$3.30
Broadcast Operator's Handbook	\$3.30
Understanding Vectors and Phase	Cloth Cover \$1.89 Paper Cover \$0.99
Inside the Vacuum Tube	\$4.50
Understanding Microwaves	\$6.00
Servicing by Signal Tracing	\$4.00
Installation and Servicing of Law Power	
Public Address Systems	\$1.89
Vacuum Tube Voltmeters (Revised)	\$4.50
Automatic Frequency Control Systems	\$1.75

JOHN F. RIDER PUBLISHER, Inc. • 480 Canal St., New York 13, N. Y.

NO SHADOWS

with new
DUAL SPOTLIGHT
Soldering Gun

Pull the trigger of your new light-duty Weller Soldering Gun, and instantly twin spotlights focus on the job—banish every shadow. Five seconds later the tip is at soldering heat! No waiting. No wasted current. This streamlined 135-watt—newest of the famous Weller line—is fast! Built compactly for working in crowded chassis, too. And the time and power you save pays for your Weller Gun in a few months.

New
135-Watt
Weller
Soldering
Gun

Specially Designed
for TV and Radio Work

- **DUAL SOLDERLITE**—Two prefocused spotlights completely eliminate shadows.
- **OVER/UNDER DESIGN**—Tube construction braces tip and improves visibility.
- **5-SECOND HEATING**—Pull the trigger and you solder!
- **LONGER REACH**—Slides easily into deep chassis; reaches the tightest corners.
- **GREATER CAPACITY**—Smaller, lighter, with greater soldering capacity.
- **TRIGGER-SWITCH CONTROL**—Adjusts heat to the job. No need to unplug gun between jobs.
- **DUAL HEAT**—Single heat 100 watts; dual heat 100/135 watts; 120 volts; 60 cycles. Handles all light-duty soldering.

See new Models WS-100 and WD-135 at your distributor, or write for bulletin direct.

- **SOLDERING GUIDE**—Get your new copy of "Soldering Tips"—revised, up-to-date, fully illustrated 20-page booklet of practical soldering suggestions. Price 10¢ at your distributor, or order direct.

WELLER
ELECTRIC CORP.

828 Packer Street, Easton, Pa.



CAPACITANCE RELAY WITH EMERGENCY D. C. SUPPLY

? Please print a diagram of an a.c.-operated capacitance relay which changes over immediately to battery operation in the event of failure of the a.c. power source.—E. J. R., San Diego, Cal.

A. The circuit is designed around a pair of 1S4 battery-type tubes which are used as the control oscillator and relay tube. The 5-ohm, 5-watt, and 5,000-ohm, 5-watt resistors are adjusted to give 1.5 volts and 90 volts respectively when the unit is operated from a 117-volt a.c. line. These voltages should be adjusted to the point where the alarm will not trigger when the unit

automatically changes over from a.c. to d.c. operation.

To adjust the unit, set the arm of R1 so that a further reduction in its resistance will trip the relay. Connect an antenna to the unit and vary the loading and sensitivity controls so the relay pulls in when anyone is within 4 or 5 feet of the antenna. Check for interference on nearby radio sets. If there is interference, vary the frequency of the oscillator circuit.

If the a.c. source should fail, the 6-volt a.c. relay releases and connects 1.5-, 90-, and 6-volt batteries to the filaments, plates, and alarm circuits.

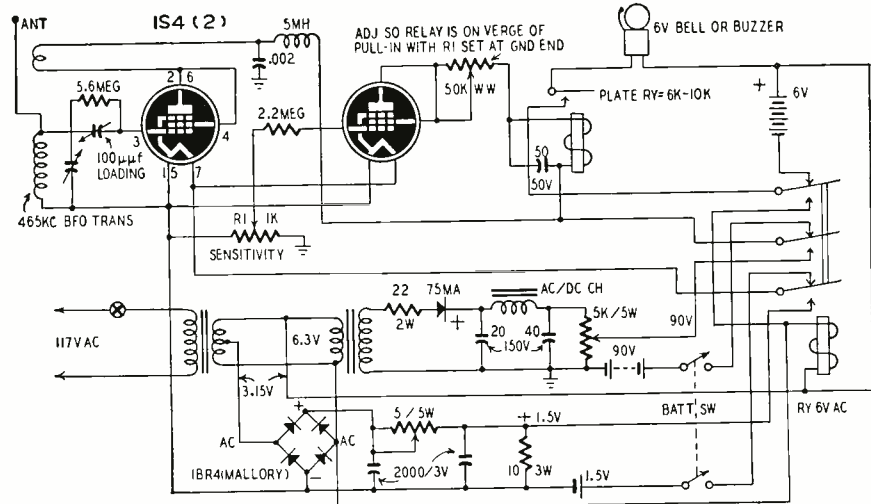

POOR SELECTIVITY ON SMALL BROADCAST SETS

? Many of my customers who own 5- or 6-tube broadcast sets—usually a.c.-d.c. models—complain that stations at the high-frequency end of the dial interfere with each other so that from about 1300 kc up is just a jumble of whistles and distorted signals. What causes this and what can be done to remedy it?—D. B., Rison, Ark.

A. Much of this trouble can be traced directly to poor selectivity. The selectivity of a set is its ability to discriminate against unwanted signals close to the frequency of the desired one. The over-all selectivity is determined by the number of tuned stages and the selectivity of each.

In any capacitance-tuned circuit, the Q—the factor which determines selectivity—decreases as the resonant frequency increases. The average small receiver has only one tuned circuit between the antenna and converter grid and a pair of 455-kc i.f. transformers between the converter plate and the second detector. A single i.f. stage at this frequency does not have sufficient selectivity to reject adjacent-channel signals which ride through because of decreased front-end selectivity at the high-frequency end of the band. This effect is most noticeable at night when the range of broadcast stations is greater.

Co-channel interference is another source of trouble. As a rule, broadcast stations at the high end of the band operate with relatively low power on

channels shared by similar stations only a few hundred miles away. When the receiver is within the night-time range of two or more such stations, annoying heterodynes result. If the desired station is reasonably strong, the trouble can be minimized by using a shorter antenna or by rotating the set for minimum interference if it has a loop antenna.

If the interference is from adjacent-channel rather than co-channel stations, then a 10-kc "tweet" or whistle filter may be tried. It may be J. W. Miller Co.'s type EL-58 or EL-60. Installation instructions are supplied with each unit. Before installing one of these filters, be sure that the set is carefully aligned for maximum selectivity.

RADIO SERVICE



Suggested by
Morley Burteen, Chicago, Ill.

"Nope. Condenser is OKay!"

RADIO-ELECTRONICS for

TUBES

FROM **Niagara Radio Supply**
ONE OF AMERICA'S GREAT RADIO STORES

AT **50% TO 90% OFF**

ALL NEW • FAMOUS BRANDS • GUARANTEED

00A	1.60	5T4	2.40	6N6	1.95	12A6GT	1.45	25Z6GT	.75
0A2	1.60	5U4G	.83	6N7GT	1.20	12A7	1.60	26B8K6	.83
0A3 VR75	1.33	5V4G	1.20	6P5GT	1.20	12A8GT	1.10	26BK6	.75
0A4G	1.33	5W4GT	.83	6P7G	1.60	12A17GT	1.33	30	.25
0B2	1.70	5X4G	.90	6Q6G	1.60	12A15	1.00	30	.25
0B3 VR80	1.33	5Y3GT	.68	6Q7GT	1.00	12A16	.75	31	1.10
0C3 VR105	1.33	5Y4GT	.75	6R7GT	.90	12A17	1.45	32	1.78
0D3 VR150	1.33	5Z3	.90	6R8	1.60	12A18	1.20	33	1.60
0Y4	2.40	5Z4	1.33	6S4	.90	12A19	.75	34	1.78
0Z4G	.83	6A3	1.60	6S7	1.33	12AV6	1.20	35 51	1.10
01A	.75	6A4 LA	1.60	6S8GT	1.33	12AV7	1.45	35A5	.90
1A3	.75	6A5G	1.95	6SA7GT	1.00	12AW6	1.33	35B5	1.00
1A4P	1.95	6A6	1.33	6SB7Y	1.20	12AX7	1.20	35C5	1.00
1A5GT	1.90	6A7	1.10	6SC7	1.00	12AY7	3.00	35L6GT	.90
1A6	1.60	6A8GT	1.10	6SD7GT	1.45	12B7	1.10	35W4	.83
1A7GT	1.10	6BA4	1.00	6SE5GT	.90	12B8GT	1.10	35Y5	.90
1A85	1.60	6B85/6N5	1.33	6SF7	1.00	12BA6	.90	35Z3	.90
1A85	1.10	6BA7 1853	1.60	6SG7	1.00	12BA7	1.20	35Z4GT	.75
1A85	1.10	6A85GT	1.45	6SH7GT	.75	12BD6	1.00	35Z5GT	.75
1A85	1.10	6A87 1852	1.45	6SJ7GT	.90	12BE6	.90	35Z6G	1.33
1B3GT	1.33	6A7G	1.10	6SK7GT	1.00	12BH7	1.20	37	.90
1B4P	1.95	6A8G	1.00	6SL7GT	1.20	12BI6	.75	37	1.10
1B5 25S	1.60	6A8GT	.90	6SN7GT	1.10	12BK6	.75	38	1.10
1B7GT	1.60	6AF6G	1.33	6SQ7GT	.83	12BN6	1.45	39/44	.25
1C5GT	1.10	6AG5	1.33	6SR7GT	.90	12BT6	.75	40	1.00
1C6	.75	6AG7	1.60	6S7	1.33	12BU6	.75	41	1.00
1C7G	.75	6AH6	1.95	6S7GT	1.45	12C6	.90	42	1.00
1C8	.75	6AJ5	1.95	6S7Z	1.10	12C6GT	1.33	42	1.00
1D5GP	.75	6AK5	1.20	6T7G	1.60	12H6	.90	45	1.00
1D7G	.75	6AK6	1.20	6T8	1.45	12ISGT	.60	45Z3	.90
1D8GT	.75	6AL5	1.33	6U4	1.20	12J7GT	1.10	45Z5GT	.90
1E5GP	.75	6AL7GT	1.33	6U5	1.00	12H7G	1.00	46	1.45
1E6GT	.75	6AQ5	1.00	6U6GT	1.20	12K7GT	1.10	47	2.40
1E7GT	.75	6AQ6	.90	6V5GT	1.45	12K8GT	1.33	48	1.33
1F5G	.75	6A4GT	1.20	6V5GT	1.95	12Q7GT	.90	49	1.33
1F6	.75	6AR5	.83	6V6	1.60	12S8GT	1.33	50	3.00
1F7G	.75	RASS	1.00	6V6GT	1.00	12SA7GT	1.00	50A5	1.10
1G4GT	.75	6AT6	.75	6V7G	.90	12SC7	1.10	50B5	1.00
1G5G	.75	6AU5GT	1.33	6W4GT	.90	12SF5GT	1.00	50C3	1.00
1G6GT	.75	6AU6	1.00	6W5G	1.33	12SF7GT	1.00	50D6G	1.45
1H4GT	1.10	6AV3GT	.75	6W6GT	1.00	12SH7GT	.75	50L6GT	.90
1H5GT	.90	6AV6	1.33	6W7G	1.33	12S7GT	.83	50X6	1.10
1H6GT	1.60	6AX5GT	.83	6X4	.75	12S7GT	.83	50Y6GT	.90
1J6	.75	6B4G	1.60	6X5	1.33	12SL7GT	1.20	50Z7G	.90
1J6GT	1.60	6B5	1.60	6X5GT	1.10	12SN7GT	1.10	52	1.95
1L4	.75	6B6G	1.60	6Y3G	1.95	12SO7GT	.83	53	1.33
1L6	1.33	6B7	1.60	7A4	1.00	12SR7GT	1.10	55	1.10
1L4A	1.33	6B8G	1.60	7A5	1.10	12Z3	1.33	56	.90
1L8A	1.33	6BA6	.90	7A6	1.00	14A4	1.33	57	1.00
1L8A	1.33	6BA7	1.20	7A7	.90	14A5	1.95	58	1.00
1L8A	1.33	6BA8	1.00	7A8	.90	14A7	1.10	59	1.78
1L8A	1.33	6BA9	1.00	7A9	.90	14A7	1.20	70A7GT	1.95
1L8A	1.33	6BA10	1.00	7B7	1.10	14B6	1.10	70L7GT	1.95
1L8A	1.33	6BA11	1.00	7B8	.90	14B8	1.10	71A	1.20
1L8A	1.33	6BA12	1.00	7B9	.90	14C5	1.33	75	1.00
1L8A	1.33	6BA13	1.00	7C7	.90	14C7	1.20	76	.45
1L8A	1.33	6BA14	1.00	7C8	1.33	14E6	1.10	77	1.00
1L8A	1.33	6BA15	1.00	7C9	1.33	14E7	1.33	78	1.00
1L8A	1.33	6BA16	1.00	7D7	1.10	14F7	1.10	79	1.33
1L8A	1.33	6BA17	1.00	7E7	1.33	14F8	1.33	80	.68
1L8A	1.33	6BA18	1.00	7F7	1.10	14H7	1.20	81	2.40
1L8A	1.33	6BA19	1.00	7F8	1.33	14J7	1.33	82	1.33
1L8A	1.33	6BA20	1.00	7F9	1.10	14N7	1.33	83	1.60
1L8A	1.33	6BA21	1.00	7G7	1.33	14Q7	1.10	84	.90
1L8A	1.33	6BA22	1.00	7H7	1.10	14S7	1.33	85	1.10
1L8A	1.33	6BA23	1.00	7I7	1.33	14W7	1.33	89	.25
1L8A	1.33	6BA24	1.00	7J7	1.33	14X7	1.33	89	1.60
1L8A	1.33	6BA25	1.00	7K7	1.33	14Y4	1.20	90V	1.60
1L8A	1.33	6BA26	1.00	7L7	1.33	15	.35	90X	1.60
1L8A	1.33	6BA27	1.00	7M7	1.33	18	.35	91	1.60
1L8A	1.33	6BA28	1.00	7N7	1.33	19	.35	92	1.60
1L8A	1.33	6BA29	1.00	7P7	1.33	19B6GG	3.00	117L7GT	1.95
1L8A	1.33	6BA30	1.00	7Q7	1.33	19C8	1.60	117N7GT	1.95
1L8A	1.33	6BA31	1.00	7R7	1.33	19G6	1.60	117P7GT	1.95
1L8A	1.33	6BA32	1.00	7S7	1.33	19H6	1.60	117Z3	.75
1L8A	1.33	6BA33	1.00	7T7	1.33	19J6	1.60	117Z4GT	1.45
1L8A	1.33	6BA34	1.00	7U7	1.33	19K6	1.60	117Z6GT	1.45
1L8A	1.33	6BA35	1.00	7V7	1.33	19L6	1.60	FM-1000	1.60
1L8A	1.33	6BA36	1.00	7W7	1.33	20	.35	XXD	1.20
1L8A	1.33	6BA37	1.00	7X7	1.33	21	.35	XXFM	1.33
1L8A	1.33	6BA38	1.00	7Y7	1.33	22	.35		
1L8A	1.33	6BA39	1.00	7Z7	1.33	24A	1.10		
1L8A	1.33	6BA40	1.00	8A7	1.33	25A6GT	1.60		
1L8A	1.33	6BA41	1.00	8B7	1.33	25A7GT	3.70		
1L8A	1.33	6BA42	1.00	8C7	1.33	25A8GT	1.43		
1L8A	1.33	6BA43	1.00	8D7	1.33	25B5	1.95		
1L8A	1.33	6BA44	1.00	8E7	1.33	25B6G	1.33		
1L8A	1.33	6BA45	1.00	8F7	1.33	25B8GT	2.48		
1L8A	1.33	6BA46	1.00	8G7	1.33	25B8GT	1.60		
1L8A	1.33	6BA47	1.00	8H7	1.33	25C6G	1.60		
1L8A	1.33	6BA48	1.00	8I7	1.33	25D8	1.95		
1L8A	1.33	6BA49	1.00	8J7	1.33	25L6	1.60		
1L8A	1.33	6BA50	1.00	8K7	1.33	25L6GT	1.60		
1L8A	1.33	6BA51	1.00	8L7	1.33	25N6G	1.15		
1L8A	1.33	6BA52	1.00	8M7	1.33	25S	1.60		
1L8A	1.33	6BA53	1.00	8N7	1.33	25W4GT	1.00		
1L8A	1.33	6BA54	1.00	8P7	1.33	25Y5	1.45		
1L8A	1.33	6BA55	1.00	8Q7	1.33	25Z5	.83		
1L8A	1.33	6BA56	1.00	8R7	1.33	25Z6	1.10		
1L8A	1.33	6BA57	1.00	8S7	1.33				
1L8A	1.33	6BA58	1.00	8T7	1.33				
1L8A	1.33	6BA59	1.00	8U7	1.33				
1L8A	1.33	6BA60	1.00	8V7	1.33				
1L8A	1.33	6BA61	1.00	8W7	1.33				
1L8A	1.33	6BA62	1.00	8X7	1.33				
1L8A	1.33	6BA63	1.00	8Y7	1.33				
1L8A	1.33	6BA64	1.00	8Z7	1.33				
1L8A	1.33	6BA65	1.00	9A7	1.33				
1L8A	1.33	6BA66	1.00	9B7	1.33				
1L8A	1.33	6BA67	1.00	9C7	1.33				
1L8A	1.33	6BA68	1.00	9D7	1.33				
1L8A	1.33	6BA69	1.00	9E7	1.33				
1L8A	1.33	6BA70	1.00	9F7	1.33				
1L8A	1.33	6BA71	1.00	9G7	1.33				
1L8A	1.33	6BA72	1.00	9H7	1.33				
1L8A	1.33	6BA73	1.00	9I7	1.33				
1L8A	1.33	6BA74	1.00	9J7	1.33				
1L8A	1.33	6BA75	1.00	9K7	1.33				
1L8A	1.33	6BA76	1.00	9L7	1.33				
1L8A	1.33	6BA77	1.00	9M7	1.33				
1L8A	1.33	6BA78	1.00	9N7	1.33				
1L8A	1.33	6BA79	1.00	9P7	1.33				
1L8A	1.33	6BA80	1.00	9Q7	1.33				
1L8A	1.33	6BA81	1.00	9R7	1.33				
1L8A	1.33	6BA82	1.00	9S7	1.33				
1L8A	1.33	6BA83	1.00	9T7	1.33				
1L8A	1.33	6BA84	1.00	9U7	1.33				
1L8A	1.33	6BA85	1.00	9V7	1.33				

Low-Priced for QUICK SALE!

All standard and nationally known tubes Many below wholesale

TV TUBES—All Black

Sheldon, Zetka & Other Standards

14" rect.23.90 16" rect. or rd. 35.90
17" rect.37.50 19" rd. metal...53.95
20" rect.56.95 All factory guaranteed

Tubes Guaranteed. Individually Boxed.

Extra Discounts—25 or more 5%, 100 or more 10%

074	\$.95	6BG6G	2.49	12M6	1.11	
1A6	1.49	6BJ6	1.49	12J7GT	1.23	
1A7GT	1.23	6CQ6GT	1.23	12K6K	1.48	
1B3GT	1.42	6R6GT92	12Q7GT	1.01	
1B5 2S5	1.79	6CB6	1.14	12SA7GT	1.12	
1C684	6CU6	2.99	12X7	1.21	
1C7G84	6F6	1.32	12XF5GT	1.12	
1D7G84	6G6G	1.48	12Y6GT	1.12	
1F484	6H6	1.72	12SH7	1.23	
1F5G84	6J5	6J5GT84	12A7	1.01
1G4GT84	6J6	2.24	12SK797	
1I6G84	6J7G or GT	1.23	12SN7GT	1.49	
1I498	6K6G	1.29	12SB7GT92	
1L6A	1.48	6K6GT92	12Z3	1.48	
1L5C	1.30	6K7	1.12	14A7	1.23	
1L6E	1.30	6K8	1.44	14B7	1.23	
1L5D	1.30	6L5	1.48	14BB	1.23	
1LN5	1.30	6L6G	1.98	14Q7	1.23	
1NSGT	1.12	6L7G	1.79	14R7	1.27	
1R5	1.05	6L7	1.34	14W7	1.27	
1S4	1.12	6N7GT	1.34	19T8	1.27	
1S5	1.28	6R6G	1.39	25A0SGGT	1.64	
1T4	1.05	6R7	1.48	25L6GT	1.03	
1U497	6S4	1.09	25Z6GT	1.03	
1U569	6S7	1.09	28D7	1.23	
1V	1.17	6SA7	1.22	30	1.23	
1X2A	1.48	6SB7Y	1.34	32L7GT	1.09	
1X3	1.23	6K4	1.29	35GT	1.09	
2A4G	1.19	6SF7	1.12	35W4	1.01	
2A5G84	6SG7	1.07	35Y484	
2A689	6T7	1.12	50A5	1.27	
2A784	6SJ7GT	1.01	50B5	1.22	
3A4	1.55	6SK7	1.01	50C5	1.22	
3A5GT	2.68	6SL7GT	1.34	50D5	1.22	
3Q499	6S779	50E5	1.22	
3S499	6SN7GT	1.09	50F5	1.03	
3V4	1.35	6S7	1.01	50L6GT	1.03	
5T4	1.73	6T8	1.48	56	1.01	
5U4C	1.35	6U7C	1.23	77	1.23	
5V4G	2.25	6V6C or GT	1.09	85	1.23	
5W491	5W4GT98	VR90	1.40	
5Z3G	1.09	6W6GT	1.49	VR150	1.40	
5Z4	1.18	6X4	1.34	25A0E1	12.50	
6A6	1.48	6Y6G94	2E22	1.95	
6A7	1.39	6X5GT89	2C24	1.95	
6A8	1.39	6Y6GT	1.01	2J21A	22.50	
6AF6G	1.28	7B4	1.01	2J32	22.50	
6AT6	1.22	7B6	1.05	2K2, 879	17.50	
6AC5	1.49	7C4	1.01	3BP1	3.50	
6AG7	1.82	7C589	5BP1	3.50	
6AH6	2.19	7E5	1.01	466A	1.40	
6AK5	1.89	7F5	1.01	70A5	4.95	
6AK6	1.44	7G7	1.48	703A	4.95	
6AL5	1.12	7H7	1.12	705A	4.95	
6AQ5	1.12	7J7	1.48	71	12.50	
6AR5	1.09	7N7	1.23	720E1	24.95	
6AS5	1.45	7Y489	803	3.95	
6AS7G	5.39	7Y684	807	1.99	
6AU5GT	1.69	12A6	1.34	815	3.95	
6AU6	1.24	12A8GT	1.23	832	6.95	
6AV5	1.69	12A7T	1.23	845	6.95	
6AV699	12AU7	1.39	872A	2.95	
6B799	12AX7	2.40	99139	
6B8	1.49	12BE6	1.09	CK100559	
6BA6	1.21	12BA6	1.09	CK100559	
6BA7	1.19	12BE6	1.89	900A79	
6BC5	1.34	12C899	900679	
6BE6	1.34	12C899	900679	

Special All American Kit — 5 Tubes — \$4.79

PART SPECIALS

Vibrators

4 Prong 6 Volt.....	\$1.19
TV HV Cartwheel Cond.
500 Mmf. 10KV.....	.49c
300 Mmf. 15KV.....	.59c
500 Mmf. 20KV.....	.69c

PM Speaker

10 or More	Each
4".....	\$1.75
5".....	1.79
8".....	3.44
12".....	6.59

PM Speaker with 50L6 Output

4".....	2.10
5".....	2.20
8" Dynamic Speaker—100
OHM Field with 50L6 Output Trans.....	\$2.69

Output Trans. Replacement For 50L6, 6V6, 6K6, 305, 3V4..... .49c |



TV-FM BOOSTER
Improved TV reception in weak signal area. Reduces noise and snow effects. Minimizes "ghosting".
List \$39.95 Our Price \$19.75

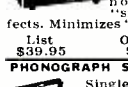

PHONOGRAPH SPECIALS
Single speed.....\$16.95
3 speed, single needle.....20.50
3 speed, automatic.....\$26.50



LATEST 30-TUBE 630 TV CHASSIS
Finest for fringe area reception. RCA licensed.
Takes all picture tubes from 19" to 20" round or rectangular.
\$158.95 Complete with Hi-gain Standard Coil Tuner and RCA Speaker (less cathode tube). Available with DuMont Tunable FM RADIO \$169.95

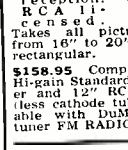

BATTERY OPERATED SIGNAL TRACER KIT
Complete with steel cabinet, speaker, all components, tubes and easy-to-follow instructions.
\$9.95 (less batteries)

Controls

1Meg w/sw 3" Shaft	54c
500K w/sw 3" Shaft	54c
1Meg w/b.P. switch
1" Knurl Shaft	49c
500K w/switch	49c
1" Knurl Shaft	49c
10K w/sw 3/8" Shaft	39c
100K w/sw 3/4" Shaft	39c
100K control
3/8" Milled Shaft	24c
250K control
3/4" Milled Shaft	24c
500K control 2" Shaft	26c

Mica Kit 100 Assorted 5.95
Ceramic Kit 100 Assorted 5.95
Resistor Kit 100 Assorted 3.79

Sockets

Molded Octal	Ea. 100
Molded Octal	12 9.95
Waffle Octal	10 9.95
Waffle Octal	.05 3.95
Waffle Min. 7 Pin	.05 3.95

Electrolytic

40x20—15V Tubular	39c
20 Mf—25V Tubular	15c
20 x 20x20—FP Type	49c
450	25
50/30/20—150V.....	.69c

TERMS: 20% cash with order, balance C.O.D. All prices F. O. B. New York City warehouse. Minimum order \$5.
NOTE: Availability of merchandise subject to prior sale. Prices subject to change without notice.

STEVE-EL ELECTRONICS CORP.
DEPT E-6 65 READE ST. NEW YORK 7, N. Y.
COntlandt 7-0086 Free catalog

COIL FRAME DATA FOR MODERN METAL LOCATOR

No information was given on the size of the cases and frames for coils used in the "Modern Metal Locator" described on page 16 of the 1948 RADIO-CRAFT REFERENCE ANNUAL. Please supply this information.—M. S. R., Waco, Texas

The cases for receiver and transmitter are 15 1/4 inches wide, 13 1/4

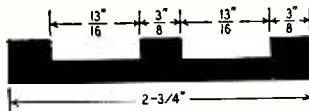

Fig. 1—Dimensions for the coil frame.

inches high, and 3 3/8 inches deep. The loop frames are built for a snug fit inside them. Frames are constructed from material approximately 3/8 inches thick and 2 1/16 inches wide. This material

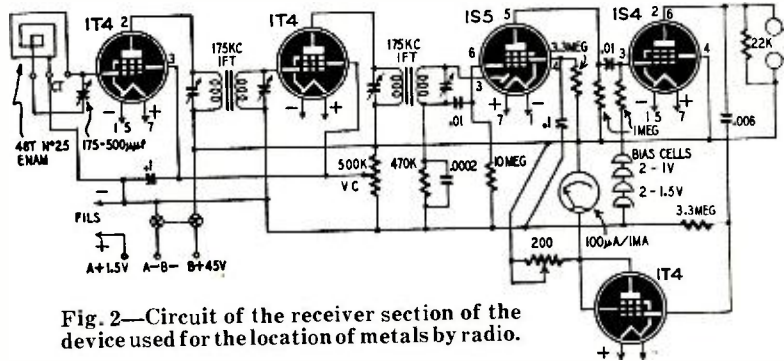

Fig. 2—Circuit of the receiver section of the device used for the location of metals by radio.

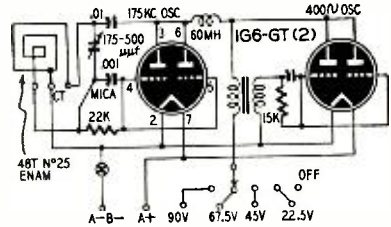

Fig. 3—The locator transmitter hookup.

The coils are laid in the grooves to prevent damage when the frames are inserted in the cases. Shelves for the transmitter and receiver are fastened inside the frames.

Diagrams of the receiver and transmitter are reprinted in Figs. 2 and 3, respectively, for the benefit of readers who have not access to the April, 1943

must be grooved with two 1/16-inch grooves as shown in Fig. 1.

issue or the 1948 RADIO-CRAFT REFERENCE ANNUAL.

HEADPHONE CONNECTION TO A.C.-D.C. RECEIVER

I want to connect a phone jack to a small a.c.-d.c. type receiver. The circuit must be wired so the speaker cuts out when the phones are plugged in. Please print a suitable circuit.—Wm. C., Miami Beach, Fla.

If this circuit is used on an a.c. set, the frame of the jack can be fastened

A. This circuit will do the job for you. The jack, a Mallory type A2A or equivalent, must be well insulated from the chassis and connected to it through a .01-μf, 600-volt blocking capacitor. Check the output transformer and speaker assembly and make sure that neither side of the voice-coil circuit is grounded before connecting the jack.

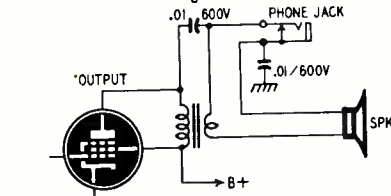

directly to the chassis, and the blocking capacitor from the jack to the chassis need not be used.

STROBOSCOPE USED FOR HIGH-SPEED ROTOR CHECK

I plan to construct the stroboscope described in the October, 1950, issue. I will increase the oscillator's frequency range to 240 c.p.s. and substitute a 1D21 Strobotron tube to provide direct calibration up to 14,000 revolutions per minute. How can I use this to check the speed of a small air turbine which I believe to be turning over at speeds between 50,000 and 75,000 r. p. m.?—C. E., Flint, Mich.

other chart. One number will appear on both charts. This number is the true speed of the rotor in r.p.m.

For example: If the first reading is 12,300 r.p.m., 2, 3, and 4 times the indicated speed will be 24,600, 36,900, and 49,200 r.p.m. respectively. The second reading will be 9,840 r.p.m. Five times this speed is 49,200. This number appears on both charts so this is the true speed of the turbine.

A. Set the stroboscope control for maximum speed, then slowly reduce its speed until the rotor appears to stand still. Note the speed in r.p.m. on the dial. Make a chart showing speeds 2, 3, 4, and 5 times the indicated speed. Reduce the speed of the oscillator until the rotor again appears to stand still. Note the dial setting and prepare an

In actual practice, there may be a slight difference between the two figures on the chart because in most cases, it is not possible to read the dial to one part in several thousand. Therefore, you can make the measurement several times and take an average of the readings. In this way you should be able to find the correct rotor speed.

ONE-TUBE RECEIVER

? Please publish a diagram of a portable broadcast receiver using a single 1D8-GT type tube. It should operate from batteries and drive a small loud-speaker on strong local stations. I would like to be able to use phones for the weaker stations.—A. E. S., Cambridge, Mass.

A. This circuit should perform as well as that of many 3-tube t.r.f. sets. High-gain antenna and r.f. coils having

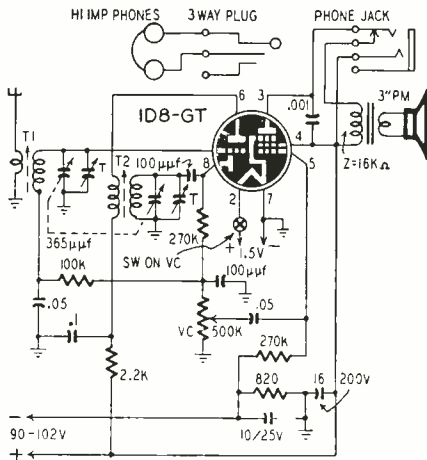

powdered-iron cores should be used for T1 and T2 respectively, to insure maximum gain and selectivity. The triode section of the tube is the r.f. amplifier, the diode is the detector and a.v.c. rectifier and the pentode is the power output stage. The heater current used by the 1D8-GT is 0.1 amp., and the total B-supply drain in this circuit will be about 7 ma.

A 3-way phone jack and matching plug are used for the phones. The jack is wired so the speaker is silenced when the phones are plugged in.

18-TUBE RECEIVER QUERY

? I am planning to build the 18-tube communications receiver described in the June, 1950, issue, but before I begin, I would like to have data for winding coils for the 160-meter and broadcast bands. I will install these coils in place of those for the 6- and 10-meter bands.—G. H. R., Akron, Ohio

A. This set uses an oscillator which tunes from approximately 5 to 7 mc on all bands. To use this set on the broadcast band (550 to approximately 1350 kc—you cannot tune much higher without getting i.f. feed-through on 1425 kc) the oscillator will have to tune from 1975 to 2825 kc. The maximum capacitance across the oscillator coil would be approximately 1,200 µf. To cover the 160-meter band, the oscillator must tune from 3175 to 3425 kc, and the total oscillator capacitance will be about 500 µf.

We do not think it wise to attempt to pad the oscillator coil so it will cover these bands. This set is engineered for optimum performance over five narrow sectors in the radio-frequency spectrum. We suggest that you use converters to cover the 160-meter and broadcast bands.

6 Easy-to-Build RCP INSTRUMENT KITS

MORE THAN 150,000 RCP INSTRUMENTS IN USE TODAY—PROVE THEIR SUPERIORITY

NOW

you can get in kit form the best professional test equipment! Made by Radio City Products one of the outstanding manufacturers of test instruments for 18 years. You get kits that are complete with all necessary parts and easy-to-follow assembly instructions. There is nothing else to buy! Yes, an RCP kit provides an enjoyable few hours in instruction and construction plus a finished test instrument at a tremendous saving!

MODEL 345K SUPER VACUUM TUBE VOLTMETER

Features long scale 4½" meter in burn out proof meter circuit—electronic balanced bridge type push-pull circuit—negligible current drawn due to high input impedance of 25 megohms—Isolation Probe—center of ohm scale 10 ohms—3 ohmmeter ranges reading from 2 ohms to 1 billion ohms (1000 megohms), 20 voltage ranges 0-1000 volts including AC and DC—Complete D.B. meter.

Discriminator alignment scale with zero center permitting operation in both directions. Operates on 105-130 volts, 50-60 cycles—Extra heavy panel, case and chassis. Size 10" x 6" x 5". Weight 8½ lbs. Shipping weight 11 lbs.

MODEL 345K KIT COMPLETE

\$25⁹⁵



MODEL 322AK TUBE TESTER KIT

Fully engineered to test all recently developed tubes and television types. Has provisions for checking individual sections of multi-purpose tubes as well as miniature and subminiature receiving tubes. Jack for head phone noise test to check noisy swinging or high resistance internal tube connections. Neon lamp for rapid short and leakage tests between elements.

KIT MODEL 322 AK, only

\$27⁹⁵



MODEL 447BK MULTI-TESTER KIT

3" square D'Arsonval meter, DC Voltmeter: 0-5-50-250-2500 Volts at 1000 Ohm per Volt, AC Voltmeter: 0-10-100-500-1000 Volts, Output Voltmeter: 0-10-100-500-1000 Volts, DC Milliammeter: 0-1-10-1000 MA, DC Ammeter: 0-1-10 Amperes, Ohmmeter: 0-10,000 Ohms-1 Megohm-10 Megohms Ext. Decibel Meter: -8 to +55 decibels. Complete with batteries.

MODEL 447BK

\$13⁹⁵

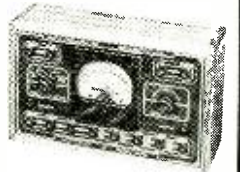

MODEL 777AK DYNATRACER

New Model Signal Tracer—Ultra Modern-Circuit design provides exceptionally high amplification so that actual gain measurements may be made. Accurate meter gives calibrated indications. Provides the speediest type of trouble shooting tool for tracing any type of disturbance or circuit defect from the antenna to the speaker. Indicates noise pickup at the aerial—checks AVC—AFC, link and filter circuits. Tube Complement 6AU6—6AT6—6AQ5 and 6X4. Crystal Rectifier 1N34. Speaker employs Alnico 5 magnet. Beautifully hammer-tone grey steel panel and case with new slendertized probe. Kit supplied complete, 105-130 volts, 50-60 cycles. Size 6½" x 8½" x 11". Weight 9½ lbs.

MODEL 777AK

\$34⁵⁰



RCP HIGH VOLTAGE MULTIPLIER KIT

Permits multiplying all ranges X100 of Model 345 or any similar impedance V.T. voltmeter. Special ceramic helical high voltage resistor certified safe for all ranges up to 33,000 volts.

KIT MODEL HVMP-1K, only

\$6⁹⁵

RCP ULTRA HIGH FREQUENCY PROBE KIT

Uses germanium crystal with low impedance network permitting measurements up to 400 megacycles.

KIT MODEL HFP-1K only

\$4²⁵

RADIO CITY PRODUCTS CO., INC.

152 WEST 25th ST — NEW YORK 1, N. Y.



NEW LOCATION

Same big bargains in new equipment

- BC348 dual-section volume control ea. \$2.50
- MC215 Tuning Shaft for SCR274N ea. \$1.25
- MC124 Tuning Shaft for MN 26 306" ea. \$6.00
- MC136 Right Angle Drive for MC124 ea. \$2.25
- MC211A Right Angle Drive for MC215 ea. 85¢
- BC732A Localizer Control Head ea. \$2.50

Please include sufficient postage.

LONG ISLAND COMPANY

P. O. Box 474, Montrose, Penn.

big **FREE** GIFT offer

SEE PAGE



BELIEVE IT OR NOT! 630 TS

TYPE CHASSIS
MFG. LICENSED UNDER
R.C.A. PATENTS

31 TUBE CHASSIS

- 1 Best for Fringe Areas
- 2 Improved Keyed A.G.C.
- 3 Full 4 Megacycle Band Width
- 4 16 KV Output
- 5 A.F.C. Sync. Separator Syncrolok
- 6 Latest 1951 Features
- 7 Focus Coil-Yoke Removable Plugs
- 8 Standard Tuner
- 9 Improved Down to 45 Microvolts
- 10 Set equipped with Phono Jack
- 11 Set uses 70° Deflection Coil
- 12 Complete Chassis with Tubes Aligned. Not a Kit
- 13 Large 12" Speaker
- 14 All Knobs—Channel Selector
- 15 Universal Mounting Brackets. Tube on Chassis
- 16 Free Plastic Mask with Every Set
- 17 Free Schematic with Every Set
- 18 Free R.M.A. Guarantee on Chassis-Tube
- 19 Free—No Extras—Tax Included
- 20 Free Delivery on Paid Order 6 or More
- 21 Dumont Tuner F.M. Radio \$10 Extra
- 22 Cabinets—Console 16" 17" 20" \$59
- 23 Cabinets—Half Doors 17" 20" \$69
- 24 Cabinets—Full Doors 17" 20" \$79
- 25 In Mahogany or Blonde. Same price.

COMPLETE CHASSIS
INCLUDING BLACK
RECTANGULAR PIC-
TURE TUBE

16" Round \$169
16" Rect. Black

17" Rect. Black \$179

19" Round \$199
20" Black Rect.

24" Black \$289

25% WITH ORDER
BALANCE C.O.D.

Dealers, Dist., Mfg.
SPECIAL PRICES
LOTS 12 OR MORE

UPSTATE, 107 DUANE, SCHENECTADY, N.Y. TEL. 4-3008

SOLD TO WHOLESALE DISTRIBUTORS ONLY

Effective April 1, 1951

ROTOR 4 CONDUCTOR WIRE

\$25.00 per/M ft. — 1000 ft. Metal Spools

300 OHM TV WIRE—POLYETHYLENE INSULATION

20 Gauge	80 Mil Web	\$22.50 per/M ft. Metal Spools
20 "	50-55 " "	20.00 " " " "
22 "	50-55 " "	17.50 " " " "
22 "	40 " "	15.00 " " " Cardboard Spools

TERMS: 30 Days Net—Rated Concerns—C.O.D. Non-Rated

Jersey Specialty Co.

LITTLE FALLS

NEW JERSEY

Phone: L.F. 4-0784-1404-1405

REPLACING A BR RECTIFIER

? I have a prewar Motorola auto radio which has a BR tube in its power supply. The tube is bad and I cannot find a replacement. Is there a substitute?—N. J., Dallas, Texas

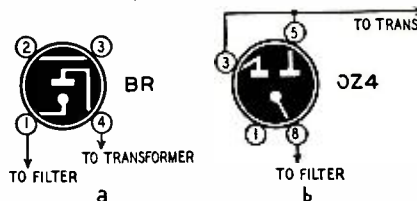

A. Replace the socket with an octal unit and rewire it for an 0Z4. A base diagram of the BR is shown at a and wiring connections for the 0Z4 are at b.

SUBSTITUTE FOR 35Z5-GT

? Can I use a selenium rectifier to replace a 35Z5-GT in a 5-tube a.c.-d.c. set? If so, kindly prepare a diagram showing the changes. I am enclosing a drawing of the rectifier and heater string in the set.—H. L., Harvey, La.

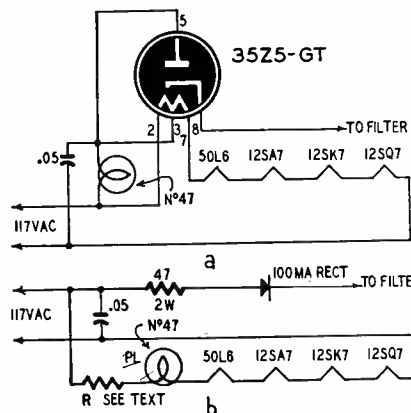

A. The original circuit is shown at a and the revision at b. Resistor R may be a Globar or Keystone type having a resistance of 1,400 ohms when cold and 200 ohms when hot.

MICROPHONE INPUT CIRCUIT

? I am planning to construct the high-gain amplifier described on page 45 of the September, 1950, issue. Please draw a diagram of the input circuit showing how I can use high-impedance microphones.—E. McD., Roselle, N. J.

A. The diagram shows how the input transformer is eliminated and the val-

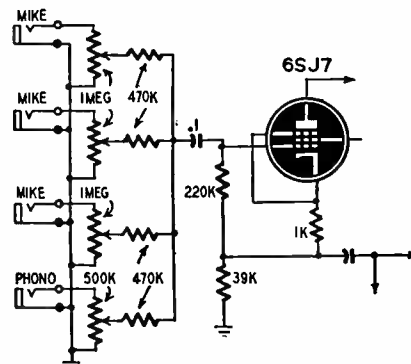

ues of the gain controls and decoupling resistors changed to adapt the amplifier to use high-impedance microphones.

—end—

MEDIUM-VOLTAGE RECTIFIERS

Amateurs and experimenters often use 83's, 83-V's, and 5Z3's in power supplies delivering up to 225 ma at 600 volts. These tubes do not last long under such operating conditions and are likely to arc or short between plate and filament. The resulting short circuit will blow fuses, or cause the primary of the transformer to burn out. A pair of 866's, 866-Jr.'s (2B26's), or 816's may be used if there is room for an additional tube, and if the filament winding is heavy enough to supply the required power.

I use a surplus 1641 RK-60 in all my supplies where the rectifier plate voltage is not more than 750 per plate. The maximum ratings for the 1641/RK60 are: 750 volts r.m.s. per plate, peak inverse voltage 2500, and output current 250 ma d.c. The internal voltage drop varies from 35 volts at 100 ma to 61 volts at 250 ma. The filament voltage is 5 volts and current is 3 amperes.

The 1641/RK-60 fits in a medium, 4-prong base with filament connections to pins 1 and 4. Plate connections are made to 0.36-inch caps on top of the tube. The envelope is 2 1/4 inches at the widest point and 5 1/8 inches from base to tip.—*Gerald Samkofsky*

SETTING SLOTTED CONTROLS

Transmitters, amplifiers, TV receivers, and numerous other electronic devices often have potentiometers or variable capacitors with slotted shafts for screwdriver adjustments. These controls are frequently under the chassis or behind a panel where the slots are difficult to find and even more difficult to keep the screwdriver in.

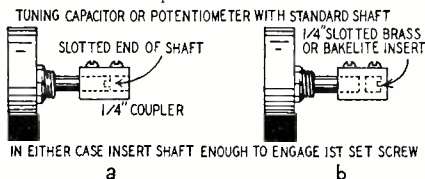

Adjusting slotted controls is simpler when a 1/4-inch metal or insulated coupler is placed over the end of the shaft as at *a* in the drawing. The drawing at *b* shows how a standard shaft can be converted for screwdriver adjustments. The shaft is fitted with a coupler and a short piece of 1/4-inch shaft which has been slotted for a screwdriver. If the control shaft is hot and must be insulated for safety, use an insulated coupler and a fiber insert.—*O. C. Vidden.*

SAFETY WITH A.C.-D.C. SETS

I have a sure-fire method of making certain that I do not get a shock while servicing a.c.-d.c. equipment. I covered one end of my workbench with sheet metal and connected it to ground through a large neon lamp. All transformerless equipment is serviced on this section of the bench. The neon lamp lights immediately when the line cord is inserted so the chassis is hot. Do not touch the chassis until you have reversed the plug. It is a good idea to mount the indicator lamp close to the power outlet where you will be sure to see it when you plug in the set.—*N. H. Kent*

1951 Edition



Ready NOW!

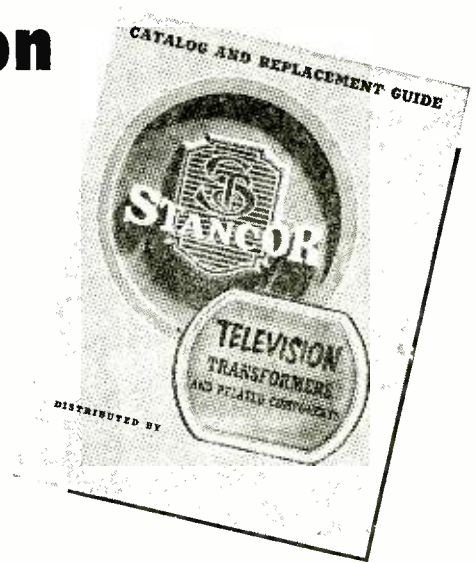

STANCOR'S

New

TV TRANSFORMER CATALOG AND REPLACEMENT GUIDE

Lists:

- Over 900 TV receiver models and chassis made by 71 manufacturers.
- Complete specifications, dimensions and prices of 75 STANCOR transformers and related components for replacement and conversion.

TAKE THE GUESSWORK OUT OF YOUR TV SERVICING! GET YOUR FREE COPY NOW AT YOUR STANCOR DISTRIBUTOR



STANDARD TRANSFORMER CORPORATION

3592 ELSTON AVENUE, CHICAGO 18, ILLINOIS

WANTED TO BUY

Large and small quantities of new or used electronic government or manufacturers' surplus tubes and equipment. Highest prices paid. State quantity, condition and best price in first letter.

Box No. F-2 c/o Radio-Electronics
25 West Broadway
New York 7, N. Y.

big FREE GIFT offer

SEE PAGE

15



PENN TV ANTENNA MOUNTS Mean QUICKER, MORE SUBSTANTIAL INSTALLATIONS!

- EASIER TO INSTALL
- SECURE INSTANTLY
- WITHSTAND WEATHER EROSION

CHIMNEY MOUNT CMA-500

A pair of heavy aluminum brackets (manufact. of special alloy) to give extra strength designed to fit the corner of chimney, correctly and securely. Complete with two lengths of heavy gauge galvanized steel strapping to fasten brackets around chimney. Designed to fit any mast up to 2" O.D. CMA-500-SS comes with stainless steel strapping. Shipped complete with all hardware, treated to withstand erosion.

Write today for FREE BULLETIN RE-651 containing dealer prices and the complete Penn TV Products line.

PENN TELEVISION PRODUCTS CO.
3336-38-40 Frankford Ave., Phila. 34, Pa.

PLATING SOLDERING IRONS

Several months ago, a reader recommended using a solution of silver cyanide (a deadly poison) for plating soldering iron tips to prevent corrosion. A much simpler method is to plate the tip of the iron with Cool-Amp, a silver plating powder which can be applied to any clean copper surface with a damp cloth. This powder is also useful in improving the contact between heavy copper conductors which are clamped or bolted together.—*R. P. Balin*

DRILLING THIN-WALL TUBING

It is difficult to start a drill into soft thin-wall tubing without using a center punch which is very likely to deform the tubing. I have solved this problem by modifying a cheap pair of gas pliers to serve as a guide for the drill. The serrations are filed or ground off the inside of the jaws and a V-groove is filed down one side as shown

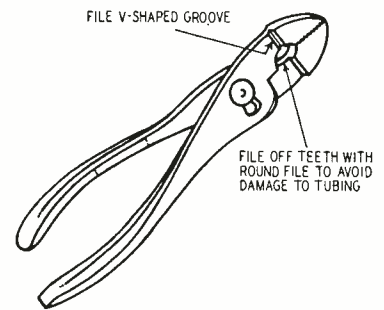

To use the tool, grip the tubing lightly with the groove centered over the spot where the hole is to be drilled. The groove is a guide for starting the drill. Remove the tool as soon as the hole is started.—*O. C. Vidden*

SIMPLE AUDIO PICKUP

Radio programs may be piped from a receiver to any recorder, amplifier, or public address system through inductive coupling between the output transformer of the set and a magnetic contact microphone connected to the amplifier. Tests have shown the strongest field to be at the top of the transformer. The mike may be suspended within 3 inches of the top of the transformer or mounted directly atop the transformer if it is cushioned with a thin layer of rubber or cork.—*Orren Reynolds*

OLD RECEIVERS MOTORBOAT

A number of old receivers have push-pull 45's and a 27 in the a.f. amplifier. Because most of these sets do not have a.v.c., tuning across a strong station will cause the set to blast and overload the 45's. Consequently these tubes soon go gassy and motorboat at the slightest provocation. Raising the bias to 60 volts helps in some cases. In others, I connect a .001-uf capacitor from the grid of the 27 to the grid of one of the 45's. This connection forms a negative-feedback loop.

It may be necessary to connect the feedback capacitor to grid of first one 45 and then the other to determine which gives the best results.—*George F. Cutress*

—end—

Over 43,000 Technicians Have Learned

HOW TO GET THE MOST OUT OF BASIC TEST EQUIPMENT

Why Not You, Too?

SERVICING by SIGNAL SUBSTITUTION

A BEST SELLER FOR OVER 9 YEARS! (NEW, UP-TO-DATE, 11TH EDITION)

The Simple, Modern, Dynamic Speed Approach To Receiver Adjustment and Alignment Problems, AM-FM-TV.

- Nothing complex to learn
- Universal — non-obsoluscent
- No extra equipment to purchase
- Employs Only Basic Test Equipment

Ask for "S.S.S." at your local Radio Parts Jobber or order direct from factory.

PRECISION APPARATUS COMPANY, INC. • 92-27 Horace Harding Blvd., Elmhurst 4, N. Y.

only **40¢**

100 pages. Invaluable information that will help you re-double the value of your basic test equipment.



Special! 300 OHM 7 STRAND TV LEAD-IN-WIRE

IMMEDIATE DELIVERY!

High quality, 7-strand copper wire covered with pure Black Polyethylene—55 mil. Available for immediate delivery. F.O.B. Baltimore, 20% deposit, balance C.O.D.

D & H DISTRIBUTING COMPANY, INC.
25 S. Liberty St. Baltimore, Md.

\$24.50 per 1000-ft. coil

Quantity prices on request



COLOR TONE ON YOUR TELEVISION

Simply attach TELECOLOR FILTER to front of set and enjoy favorite programs in wonderful glorious color tone instead of dull black and white. TELECOLOR FILTER is one of the latest discoveries, its special formula coloring gives brilliant, pleasing, genuine color tone, life like color depth, reduced eyestrain and glare. See our January ad—page 114—Free information!

MAIL COUPON NOW!

ORDER BY MAIL

HARVARD LABORATORY, Dept. RE-6
659 Fulton Street, Bklyn. 1, N.Y.

Please send TELECOLOR FILTER

10 inch \$ 3	Cash <input type="checkbox"/>
12, 14 inch 4	Check <input type="checkbox"/>
16, 17 inch 6	M.O. <input type="checkbox"/>
19, 21 inch 10	Send C.O.D. <input type="checkbox"/>

Screen size Amount

NAME

ADDRESS

CITY STATE



"Live artist" quality is a characteristic of the new RCA Victor "Personal" radio, one of the most compact ever built.

How to hold a band in your hand!

Tune in this RCA Victor "Personal" radio—no bigger than a book. Out pour the full tones of any orchestra—so full of "living presence"—that it's like holding a band in your hand.

This compact instrument grows directly from basic research conducted at RCA Laboratories. Scientists and engineers here perfected highly efficient circuits and electron tubes—powered by compact RCA Batteries. Its built-in antenna gives peak performance anywhere—at home or "on the

road." Its miniature loudspeaker offers fine acoustical performance in a minimum of space.

Development of this handsome portable radio, weighing less than 4 pounds, is another example of RCA research and engineering at work for you. Result: a totally new satisfaction from a small "Personal" radio.

* * *

See the latest wonders of radio, television and electronics at RCA Exhibition Hall, 36 West 49th Street, N. Y. Admission is free. Radio Corporation of America, RCA Building, Radio City, New York 20, N. Y.



See the compact new RCA Victor "Personal" radio today. Model B411—now on display at your local RCA Victor dealer's.



RADIO CORPORATION of AMERICA
World Leader in Radio — First in Television

CONCORD SCOOP!



SAVE 50%
ON THIS
FM
TUNER
995
Your Net

Enjoy clear, static-free reception of your favorite music and sports events--convert to FM for less than \$10.00 with this Exclusive Concord FM tuner. Easily converts any AM receiver, phono amplifier or PA system for FM. Covers the entire 88-108 FM band. Tuning and on-off controls on front panel with terminals for connection of 300 ohm twin lead antenna on back. Extremely easy to install... Uses a 7F8 in a fremodyne circuit, plus a 6H6 rectifier. Size of chassis: 6-3/4 x 4 x 4-1/8". Complete with tubes. For 110-120 volts, AC-DC. 99-9502J--Shpg. Wt. 2 lbs. Net. 9.95

DUAL VIBRATOR POWER PACK 995

Your Net



Another Special Concord Exclusive!... Selling at a fraction of its original cost. Brand new vibrator power supply... ideal for mobile amateur rigs (transmitter & receiver) or mobile Public Address systems. Compactly designed cabinet can be easily mounted under auto dashboards. Two vibrators supply dual output: 400 volts at 150 ma; 225 volts at 60 ma with slight modification. Enclosed terminal board provides lugs for connecting handset, microphone, and speaker. Unit also has provisions for mounting speaker inside. Controls on front panel include: channel selector, on-off switch, squelch control (cuts out all noise when no signal is being received), and volume control. Supplied with instructions for modification but less vibrators. Size: 6-5/8 x 6 x 5-1/8". 99-9627J--Shpg. Wt. 9 lbs. Net. 9.95
Kit of 2 vibrators and vibrator socket for modification of above unit. 99-3957J--Shpg. Wt. 1 lb. Net. 5.79

THOUSANDS OF SIMILAR BARGAINS ARE YOURS AT CONCORD RADIO

SEND FOR LATEST BUYER'S GUIDE

FILL IN AND MAIL TODAY

CONCORD RADIO CORP. Dept. JF-51
901 West Jackson Blvd., Chicago 7, Illinois

Enclosed \$..... (Include shipping charge. Any excess will be refunded.) Rush me the following equipment.

- 99-9502J FM Converter \$9.95
- 99-9627J Vibrator Power Pack \$9.95
- 99-3957J Vibrator Kit \$5.79
- Send FREE latest Buyer's Guide

Name.....
Address.....
City..... Zone..... State.....

MULTIPLE-BAND PANORAMIC RECEIVER

Patent No. 2,530,693
Estil I. Green, Millburn, N. J.

(Assigned to Bell Telephone Laboratories, Inc.)

This panoramic receiver can cover an unusually wide frequency range. All signals intercepted by it are displayed on an oscilloscope. The horizontal sweep of the scope is synchronized with the sweep of the local oscillator frequency. The demodulated receiver output feeds the vertical plates of the scope.

This i.f. can pass through channel A. If the r.f. is in the range 9990-10000 kc the beat will be 475 kc, which is the frequency of channel B. Frequencies between 9980-9990 kc create a beat of 485 kc and pass through channel C. If there were 10 channels, the receiver could cover a range of 100 kc although the oscillator is swept through

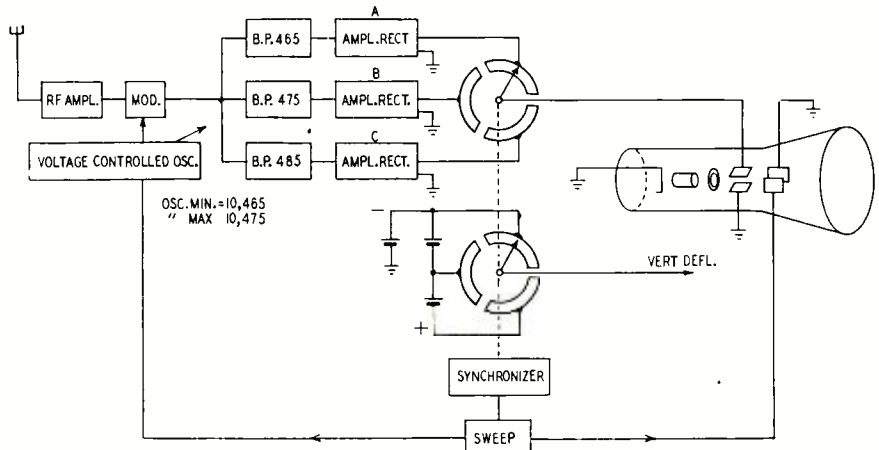

As the oscillator sweeps through its band it may heterodyne r.f. signals. Each beat appears as a vertical line on the screen. The height of each line indicates signal intensity. The position of each line (along the time-baseline) shows the frequency of the signal. The baseline may be calibrated in mc if desired.

No bandswitching is used in the local oscillator or r.f. circuits. The oscillator is swept over a range of 10 kc. The r.f. stages are untuned wide-band amplifiers. Several sharply tuned i.f. channels are used, one at a time being connected to the scope through a rotating switch.

As the oscillator sweeps through its band (see figure) it creates a 465-kc beat whenever it heterodynes an r.f. signal between 10000-10010 kc

only 10 kc.

The output of each channel is connected in turn to the scope. The lower pole of the gangrel switch controls a d.c. supply. This may be fed to the vertical plates to control the height of the oscilloscope baseline. For example, with the switch as shown, channel A is in the circuit. At this time the d.c. supply is negative so the baseline is below center. When channel B is connected, the d.c. is zero and the horizontal baseline runs through the center of the screen. For channel C, the d.c. is positive, so the baseline is above center. The switch rotates rapidly so 3 baselines appear simultaneously, each displaying signals within the corresponding band. As many base lines are used as there are channels in the system.

SAWTOOTH GENERATOR FOR ELECTROSTATIC TUBES

Patent No. 2,509,761

Robert M. Crooker, Chicago, Ill.

(Assigned to Motorola, Inc.)

This is an efficient circuit for horizontal deflection of an oscilloscope or small kinescope using electrostatic deflectors. It provides a sawtooth with an amplitude of about 450 volts from a B-supply of only 235 volts. The linear sweep is built up by charging a pair of capacitors in series. A blocking oscillator discharges them quickly to end the wave.

When the circuit is first turned on, C1 charges uniformly from the B-supply through L1. Because L1 is tightly coupled to L2, an equal but opposite current flows through L2 to charge C2. The upper plate of C1 becomes positive, the lower plate of C2 negative. This arrangement doubles the available output for the deflector plates.

The triode plate supply is equal to the total potential across C1, C2. As the charge increases the triode begins to conduct. Current through L3 induces a voltage across L4, which is phased to make the grid positive. Therefore conduction increases rapidly and the tube impedance is greatly reduced. Now C1, C2, L3 form an oscillator circuit through the tube. The capacitors discharge, then recharge in the opposite direction so that the upper plate of C1 becomes negative and the lower plate of C2 positive. By this time grid current is sufficient to block the tube again and the next charging cycle begins.

The sweep voltage is large for two reasons. C2 doubles the sawtooth that can be obtained by charging one capacitor (C1). Also, after the first cycle, C1 can charge uniformly over a wide

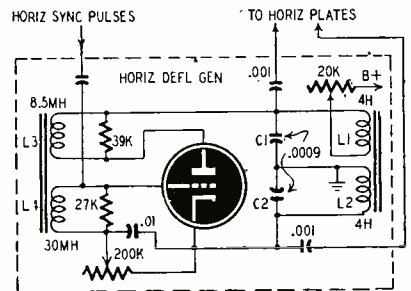

range. As described above, C1 is negative when it begins to take current from the B supply. Therefore the charging range is the same as if C1 were discharged and the B supply doubled.

As in any charging circuit, to preserve linearity, C1 can be charged to only a fraction of the power-supply voltage.

CONTROL OF HALL EFFECT IN GERMANIUM CRYSTALS

Patent No. 2,536,806

Albert Hansen, Jr., Nahant, Mass.

(Assigned to General Electric Co.)

Certain materials like bismuth and germanium exhibit the "Hall effect." This effect is illustrated at a in the figure. A small plate of germanium is shown at H. A magnetic field passes through H at right angles to a current I. Due to the Hall

effect, an e.m.f. is generated through H at right angles both to the field and to the current. In this case the output e.m.f. would be in a vertical direction through H.

Points A and B must be at exactly opposite

ends of H. Otherwise a component of voltage drop (due to I) is present across the output terminals. R is added to compensate for this possible error.

A control circuit based on the Hall effect is shown at b. The pointer of the d.c. meter is counterbalanced with a small magnet PM which

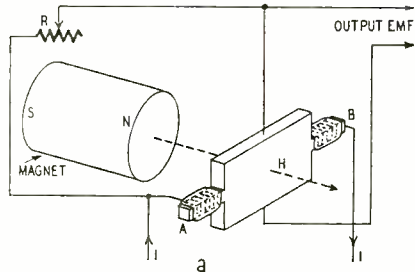

rides along the curved slot. H1 and H2 are Hall plates fed with a.c. from potentiometer P. When the pointer is near 10 on the dial, PM passes near H1. Due to Hall effect, an a.c. is fed to transformer T1 and amplifier A1. Relay RY1 is operated to control the desired function. PM excites H2 when the pointer drops to about 4. Then

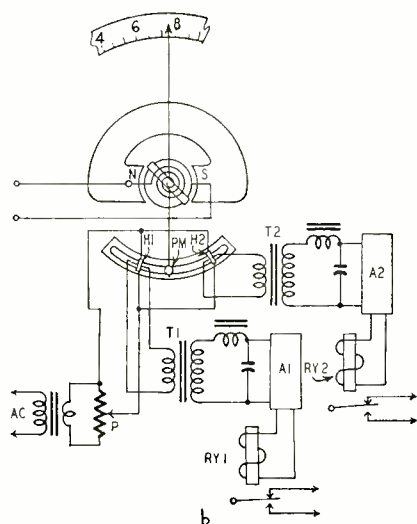

a.c. passes through T2 and feeds A2. This operates RY2 and some other function is controlled.

As an example, the meter may indicate the output of a thermocouple. When the low point is reached, RY2 can turn on the heat. At the other end of the scale too much heat is registered and RY1 may be used to disconnect the heater.

ABSORPTION-TYPE PICKUP

Patent No. 2,530,087

Chester M. Sinnett, Westmont, N. J.
(Assigned to Radio Corp. of America)

This variable capacitance pickup feeds a conventional a.f. amplifier. The stylus has negligible mass and reproduces a wide frequency range.

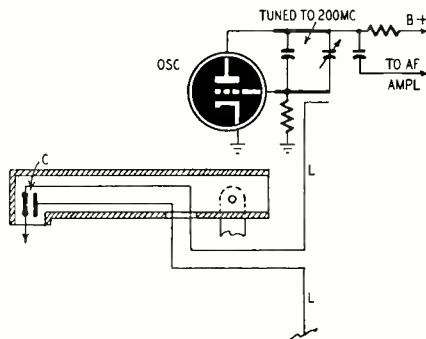

A metallic electrode is fixed adjacent to the stylus. As the stylus vibrates it changes capacitance C between itself and the electrode. The pickup is connected to a half-wave line L coupled to an oscillator. As C varies, it controls the power which L absorbs from the oscillator.

The tube plate current is modulated at an audio rate by the absorption of the line.

Only General Industries provides a Complete line of

RECORD-CHANGER MOTORS

Three Speed
Dual Speed
Single Speed

TURNTABLE MOTORS

Three Speed
Dual Speed
Single Speed

PLUS the popular, profitable

MODEL 250

Tape-Disc

RECORDER ASSEMBLY



Records on tape* Plays back both*
Records on discs* Plays any 78
R.P.M. Record*

*When connected with proper amplifier

The GENERAL INDUSTRIES Co.

DEPARTMENT C • ELYRIA, OHIO

HAVE YOU A JOB FOR A TRAINED TECHNICIAN?

We have a number of alert young men who have completed intensive training in Radio and Television Repairing. They learned their trades thoroughly by working on actual equipment under personal, expert supervision. If you need a trained man, we invite you to write for an outline of our course, and for a prospectus of the graduate. No fees, of course. Address:

Placement Manager, Dept. P108-6

COMMERCIAL TRADES INSTITUTE
1400 Greenleaf Chicago 26

IF You are buying or building a TAPE RECORDER

OR ... you are a RECORDER ENTHUSIAST

don't fail to read A. C. Shaney's dynamic new booklet

ELEMENTS of SINGLE AND DUAL TRACK TAPE RECORDING and 1001 APPLICATIONS

3rd printing, increased to 144 pages!
Price still \$1.00 postpaid
Order today. Enclose dollar bill, check or money order

Booklet mailed same day

AMPLIFIER CORP. of AMERICA
398-2 Broadway, New York 13, N. Y.

Examine FREE

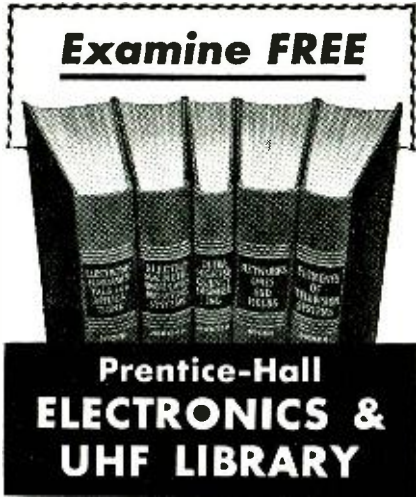

**Prentice-Hall
ELECTRONICS &
UHF LIBRARY**

Edited by W. L. EVERITT

5 VOLUMES 1662 ILLUSTRATIONS
Pay Easy Installments if You Keep the Set

Turn to this new, up-to-date Library with complete confidence, for dependable facts on any phase of modern electronic theory and practice. These volumes, by outstanding authorities, give you thorough guidance—clearly written, logically arranged, profusely illustrated.

Electronic Fundamentals and Applications

By Prof. John D. Ryder, Univ. of Illinois
Complete, logical, easy-to-follow treatment of (a) physical principles underlying electron tubes, (b) characteristics of vacuum tubes, (c) all basic tube circuits. Includes: Electron Ballistics. Cathode-Ray Tubes. Emission of Electrons. Space Charge in Vacuum Tubes. Diode Rectifiers. Triodes. Multi-Element Tubes. Small-Signal Amplifier Circuits. Audio-Frequency Amplifiers. Radio-Frequency Amplifiers. Oscillator Circuits. Modulation Systems. Wave-Shaping Circuits. Gaseous Conduction. Gas Control Tubes and Circuits. Photoelectric Cells. Solid-State Electronics.

Electromagnetic Waves and Radiating Systems

By Prof. Edward C. Jordan, Univ. of Illinois
Covers entire field of electromagnetic engineering. Includes propagation as well as radiation and transmission. Full treatment of UHF transmission lines, wave guides, antennas, slot antennas, radiation and diffraction, ground-wave and sky-wave propagation.

Ultra High Frequency Engineering

By Thomas L. Martin, Univ. of New Mexico
Theory and technique of ALL the new fields of electronic engineering: Radar, Telemetry, Electronic computing, Facsimile, Television, Blind landing systems, Pulse-time modulation, Ionosphere measurements . . . and the others.

Networks, Lines and Fields

By Prof. John D. Ryder, Univ. of Illinois
Network transformations and theorems. Resonance. Impedance transformation and coupled circuits. Filters. General transmission line. High-frequency line. Equations of the electromagnetic field. Radiation. Transmission and reflection of plane waves at boundaries. Guided waves between parallel planes. Wave guides.

Elements of Television Systems

By George E. Anner, New York University
Complete basic theory, plus current practice, covering: Closed TV Systems. Commercial Telecasting Systems. Color TV Systems. Gives clear exposition of all phases of picture transmission, including the new technique of dot interlace.

SEND NO MONEY—EXAMINE FREE

Just mail coupon below to get complete 5-Volume Set on 10 DAYS' FREE TRIAL. If not completely satisfactory, return in ten days and owe nothing. Or keep the set and pay only \$5.35 down and \$8 a month for five months until full price of \$45.35 is paid. Decide for yourself—without risk or obligation—just mail coupon to examine Library ten days free.

Prentice-Hall, Inc., Dept. M-RE-651
70 Fifth Avenue, New York 11, N.Y.

Send me the Prentice-Hall, ELECTRONICS & UHF LIBRARY (5 Volumes) for ten days' free examination. If fully satisfied in ten days I will send you \$5.35 plus few cents postage and then \$8 a month for five months until full price of \$45.35 is paid. Or I will return the Library in ten days and owe nothing.

Name

Address

City and State

PERIODIC METER DAMPING

Patent No. 2,526,006

Ralph V. Cress, Syracuse, Ind.
(Assigned to Penn Electric Switch Co., Goshen, Ind.)

This invention provides meter damping without reducing sensitivity. Motor M operates a cam

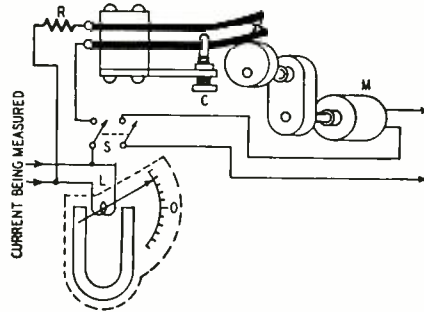

which opens and closes a circuit shunting meter coil L. While the circuit is closed, R damps the meter movement by absorbing power from it. During open-circuit intervals, damping is removed and the needle is deflected normally. Knob C controls the ratio of time during which damping exists to the time when it is absent.

An optimum value of R may be chosen by experiment for the particular galvanometer to be damped. Then C is adjusted until the needle defects in minimum time without overshooting or oscillation.

After the needle has come to rest, S may be opened. This disconnects both M and R, to assure accuracy of the final reading.

FREQUENCY MEASUREMENT

Patent No. 2,537,104

Albert H. Taylor,
Prince George's County, Md.
(May be used by the U. S. Government without royalty payment)

This is an improvement over the usual method of Lissajou figure measurement. A standard frequency F_s (preferably fixed for high accuracy) is compared with an unknown F_x by means of an oscilloscope. When F_x/F_s is a small integer or fraction, the oscilloscope pattern remains stationary and the unknown is easily calculated. The new invention permits accurate measurement even when the pattern is not stationary.

F_x is fed to a phase splitter and amplifiers. The outputs of the two amplifiers have equal amplitude but their phases differ by 90° . Therefore the CRO sweep is a circle (shown by dotted lines in the figure). When F_x modulates this sweep, a wavy pattern appears. If F_x/F_s is an exact integer N, the pattern remains stationary and there are N cycles. The figure shows a pattern which results when $F_x = 6 F_s$.

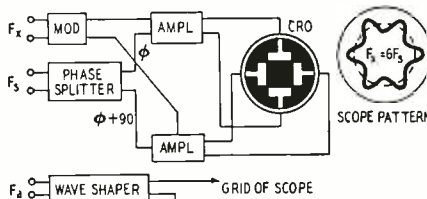

When F_x/F_s is not an exact integer the wavy pattern appears to rotate in one direction or the other. This rotation can be "stopped" by stroboscopic methods. This is done by F_a and the wave shaper which frequency-modulates the oscilloscope grid and periodically blanks out the pattern. To calculate F_x , the stroboscopic frequency F_a is adjusted to a high frequency and gradually reduced until the rotating pattern appears to stop. Then the unknown equals $F_x = N F_s \pm F_a$.

F_a need not have the high accuracy of the standard frequency. As an illustration, assume that F_s is 102 cycles and F_x is 1,000. The pattern will contain 10 cycles and will appear to rotate. Motion will appear to stop when F_a is 20 cycles. If F_a has an accuracy of 5% it will be in error by 1 cycle so F_x will be known accurately to within 0.1% or 1 part in 1,000.

As in any stroboscope, F_a can stop the motion at more than one frequency. Use the highest value. Note also that F_a is added or subtracted from $N F_s$ to find F_x . The correct sign depends upon whether the pattern rotates in one direction or the other. It may be determined experimentally for a given circuit and oscilloscope.

PM ERASING HEAD

Patent No. 2,535,498

Otto Kornei, Cleveland Heights, Ohio.
(Assigned to Brush Development Co.)

This erasing head is of the PM type. The magnetized tape travels past two bar magnets fixed in position. These magnets produce an alternating, decaying field which demagnetizes the tape and erases the sound recorded on it.

As the figure shows, the tape approaches the first magnet nearly perpendicularly (from the left in the figure). It recedes from the second magnet at an angle between 3° and 10° . The magnets themselves make an angle of about 80° with each other.

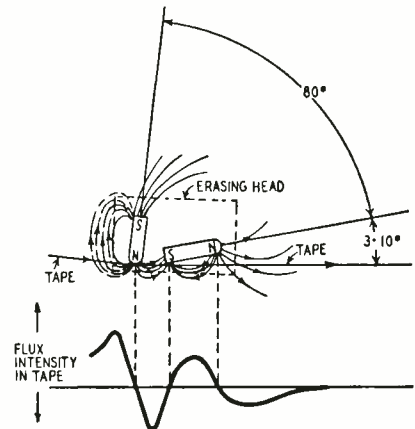

The field created by the first magnet is stronger than any recorded on the tape. This obliterates all residual recordings. As the tape moves adjacent to the N pole of the first magnet it enters a neutral field because of the divided flux from this pole. The field reverses between the magnets. The second magnet produces another magnetic cycle which tapers off to zero.

POWER SUPPLY FOR BIAS

Patent No. 2,536,830

Garet F. Ziffer, Syracuse, N. Y.
(Assigned to General Electric Co.)

This is a single-tube circuit which provides voltage for bias purposes. Its output is constant and its ripple low.

The plate current of a pentode is determined mainly by the voltages on the screen and control grids. In this circuit the two elements are

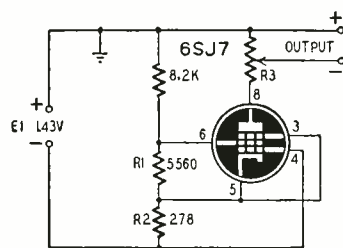

connected to have opposite effects. For example, when E1 rises, there is an increase in screen voltage while the control grid goes more negative. By properly selecting R1 and R2 these effects become equal as well as opposite. Therefore the plate current remains constant when E1 varies. Output voltage is taken from potentiometer R3.

Component values are shown for a 6SJ7. According to the inventor, this circuit shows less than 0.1% ripple for an E1 ripple of 20%. The output voltage remains constant to better than 0.5% even when the input is varied as much as 50%.

—end—

**CAPACITANCE-TUNED
FREQUENCY BRIDGE**

The Wien bridge is a perennial favorite with experimenters as an inexpensive, tunable frequency-selective network. It is especially useful for identifying unknown audio frequencies by the null method, as a selective feedback network in tuned amplifiers, and as a heterodyne eliminator ("heterofil") in radio receivers. The single practical drawback of this circuit has been the difficulty in obtaining inexpensive ganged potentiometers with satisfactory tracking between sections.

This difficulty is overcome in the accompanying circuit by varying the dual capacitors of the bridge, instead of the resistors. It is, of course, much easier to obtain good tracking between tuning capacitor sections than between dual volume controls. A common 365- μf -per-section unit is used.

This circuit is not a true Wien bridge in the strictest sense, since the normal positions of C1 and R2 have been interchanged. This was done to use a standard tuning capacitor with common rotors. The null response is very good, however, when using headphones or v.t.v.m.

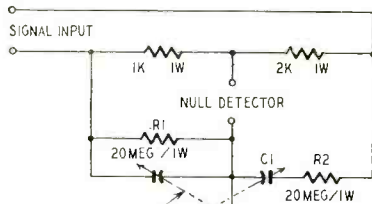

DUAL 365 μf B C TUNING CAP

Circuit of the capacitance-tuned bridge.

Tuning range of the circuit shown is 18 to 370 cycles. This rather extended range may be restricted, if desired, by using a padder in parallel with each tuning capacitor section. The basic range may be multiplied in suitable steps by changing simultaneously the values of R1 and R2. When R1 and R2 each are 2 megohms, the range is 180 to 3,700 cycles; and when they are each 200,000 ohms, the range is 1,800 to 37,000 cycles. Because of unavoidable stray capacitances, there may be some difficulty in obtaining clean, sharp nulls at frequencies above 20,000 cycles.

By using a ganged switch to change R1 and R2, the bridge can be made to cover the full audio range from 18 to 37,000 cycles in only three steps. If stray capacitance is kept low, only one dial scale need be used to cover all three ranges.

To eliminate body capacitance effects, a ceramic coupling *must* be placed between the tuning capacitor shaft and a bakelite shaft attached to the tuning knob. Also, the tuning capacitor must be mounted at least 3 inches back of the fingers. If the rotors of the tuning capacitor are grounded, as shown in the diagram, the signal input source must not be. However, the null detector can be. If, on the other hand, the signal source is grounded, the rotors and null detector cannot be.—Rufus P. Turner, K6AI

**CIVIL DEFENSE BOOMS MARKET
FOR WARD MOBILE ANTENNAS**

**HAMS, FEDERAL, STATE, MUNICIPAL
AND COMMERCIAL FLEET OPERATORS
NEED 2-WAY COMMUNICATIONS**

Your big market for radio communication equipment is wide open. Civil Defense preparation is vastly widening the demand. Your sales potential will be greatly increased by handling Ward special purpose antennas and mounts. Ward engineered antennas and mounts meet all installation requirements . . . stand the gaff of hardest mobile use. A special selling advantage is Ward's capacity to not only supply complete antenna units for initial installation, but to provide separate components that may be combined to solve any requirement. Be ready to fill the urgent and constantly growing need for mobile communications . . . order and stock Ward SPP antennas and mounts . . . TODAY.

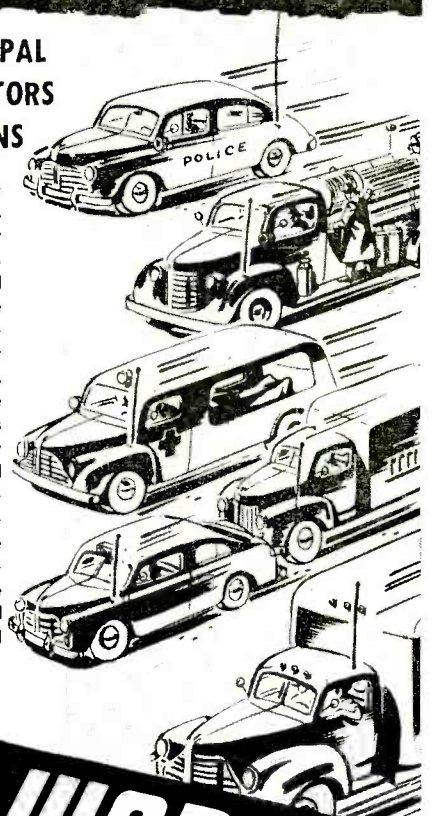

THE WARD PRODUCTS CORPORATION

Division of the Gabriel Co.
1523 East 45th Street
Cleveland 3, Ohio
IN CANADA:
ATLAS RADIO CORP. LTD.,
Toronto, Ontario



SPP-3B SINGLE ROD

SPP-71 OR SPP-143 UNIVERSAL MOUNT

SPP-3 SWIVEL BASE

SPP-3A SHOCK MOUNTING SPRING

SPP-18 ROOF MOUNTED ANTENNA

SCARCE RADIO TV TUBES

TUBES BOUGHT, SOLD, and TRADED SEND YOUR WANT and TRADE LIST!

Many Types Available for IMMEDIATE DELIVERY—WRITE NOW!
Radio and TV servicemen, experimenters, amateurs . . . we have many types of scarce tubes ready for immediate shipment. Don't use make-shifts or spend valuable time looking for tube sources. Try Electro FIRST . . . and get the tubes you need without delay. Get complete list and Electro's low prices. It's FREE . . . write today!

ELECTRO SALES 427 West Randolph St. Chicago 6, Illinois

EASY TO LEARN CODE

It is easy to learn or increase speed with an Instructograph Code Teacher. Affords the quickest and most practical method yet developed. For beginners or advanced students. Available tapes from beginner's alphabet to typical messages on all subjects. Speed range 5 to 40 WPM. Always ready—no QRM.



ENDORSED BY THOUSANDS!
The Instructograph Code Teacher literally takes the place of an operator-instructor and enables anyone to learn and master code without further assistance. Thousands of successful operators have "acquired the code" with the Instructograph System. Write today for convenient rental and purchase plans.

INSTRUCTOGRAPH COMPANY
4701 Sheridan Rd., Dept. RC, Chicago 40, Ill.

MOST POPULAR RADIO & TV TUBES
STANDARD BRANDS—FULLY GUARANTEED

OZ4S	.98	65J7GT	1.19
1A5GT	1.04	65K7GT98
1A7GT	1.37	65L7GT	1.19
1B3GT	1.94	65N7GT	1.62
1H5GT	1.12	65Q7GT	1.08
1LA6	1.69	65S789
1LB4	1.69	6T8	1.89
1LC5	1.69	6U586
1LC6	1.69	6V6GT	1.32
1LD5	1.69	6W4GT	1.24
1LE3	1.69	6X495
1LH4	1.69	6X5GT98
1LN5	1.12	6Y6G	1.74
1N5GT	1.04	6ZY5G	1.69
1Q5GT	1.09	7A5	1.08
1R5	1.59	7A8	1.47
1S4	1.07	7B4	1.08
1S5	1.04	7B5	1.08
1T4	1.12	7B6	1.08
1T5GT	1.24	7B7	1.47
1U498	7C5	1.08
1U598	7C6	1.08
1X2	1.68	7F7	1.69
3A8GT	2.97	7F8	1.96
3Q4	1.38	7Q7	1.08
3Q5GT	1.44	7V7	1.47
3S498	7Y489
3V4	1.19	12AH7GT	1.64
5T4	2.17	12AL5	1.26
5U4G	1.08	12AT6	1.08
5V4G	1.87	12AT7	1.89
5W4	1.14	12AU697
5Y3GT79	12AU7	1.98
5Y4G98	12AV6	1.17
5Z3	1.07	12AX7	1.63
5Z4	1.28	12BA6	1.08
6A7	1.06	12BE6	1.08
6AB7	1.89	12J5GT97
6A8GT	1.29	12K7GT	1.04
6AC7	2.29	12Q7GT	1.04
6AF6G	1.44	12SA7GT98
6AG5	1.74	12SF598
6AG7	1.92	12SF7	1.08
6AH6	2.29	12SG7	1.08
6AK5	2.34	12SJ7GT	1.08
6AK6	1.47	12SK7GT98
6AL5	1.69	12SL7GT	1.49
6AL7GT	1.88	12SN7GT	1.39
6AQ5	1.49	12SQ7GT98
6AQ6	1.24	12SR798
6AQ7GT	1.67	14A4	1.08
6AS7G	5.76	14A7	1.08
6AT6	1.08	14B6	1.08
6AU5GT	1.89	14Q7	1.08
6AU6	1.69	14R7	1.08
6AV6	1.37	19B6G	3.64
6AX5GT97	19T8	1.49
6B6G84	24A	1.17
6BA6	1.08	25A6	1.49
6BE6	1.08	25L6GT	1.14
6BG6G	2.89	25W4GT	1.36
6BC5	1.74	25Z598
6BH6	1.45	25Z6GT	1.08
6BJ6	1.37	2797
6BQ6GT	1.87	35A5	1.28
6C4	1.49	35B5	1.32
6C5GT98	35L6GT	1.24
6C674	35W4	1.08
6CB6	1.74	35Y4	1.36
6CD6G	3.45	35Z3	1.34
6D674	35Z5GT98
6E5	1.46	36	1.62
6F5GT99	41	1.19
6F6GT	1.07	42	1.32
6G6G	1.22	43	1.32
6H6GT	1.08	45	1.29
6J5GT87	45Z5	1.08
6J6	1.97	47	1.38
6J7GT98	50A5	1.54
6K5GT	1.62	50B5	1.24
6K6GT	1.08	50C5	1.24
6K7GT	1.08	50L6GT	1.24
6L6G	1.85	70L7GT	1.87
6N7GT	1.47	75	1.08
6P5GT	1.47	7698
6Q7GT	1.08	7798
6SA7GT	1.08	7898
6SC789	8079
6SF5GT89	117L7GT	1.98
6SF797	117N7GT	1.98
6SG7	1.19	117Z398
6SH7	1.69	117Z6GT	1.62

ONLY AVAILABLE TUBES WILL BE SHIPPED
SEND NO MORE THAN 20% DEPOSIT
BROOKS RADIO & TELEVISION CORP.
84 Vesey St., Dept. A, New York 7, N. Y.

REVAMPING A TRIPLETT SIGNAL GENERATOR

The Triplett Model 3432 AM signal generator has two characteristics which can limit its usefulness in a service shop. Although its power transformer has an electrostatic shield, enough r.f. is radiated through the

Change the bleeder resistor from 30,000 to 50,000 ohms. Break the B-plus lead to the r.f. oscillator and insert a 470-ohm, 2-watt resistor. Connect an OA2 between ground and the junction of the 470- and 10,000-ohm resistors.

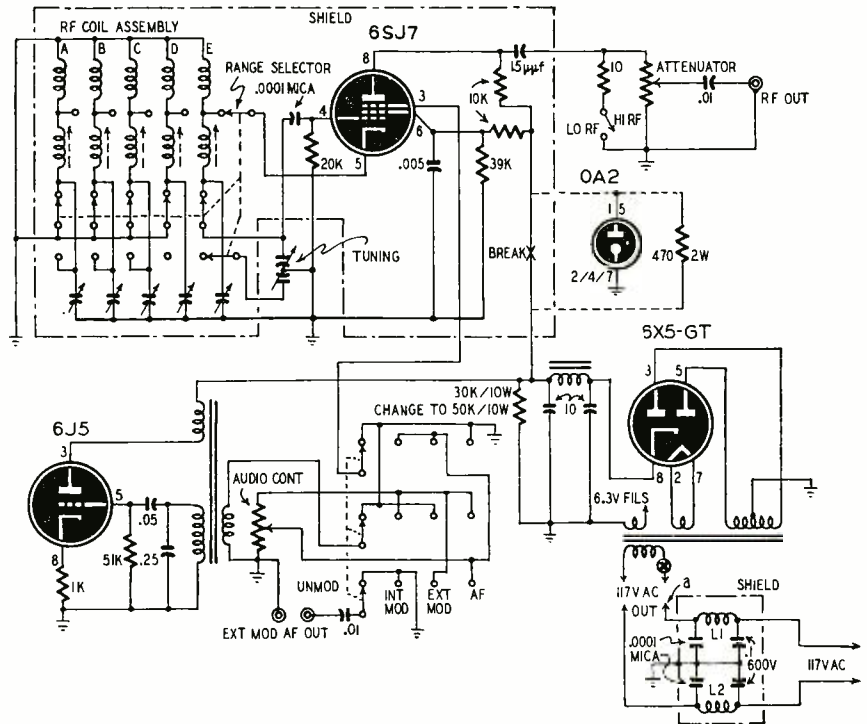

power line to cause interference to nearby radio and TV receivers and make alignment difficult if not impossible. Frequency shift with line-voltage variations also does its share to make servicing difficult.

The drawing shows the diagram of the 3432 and changes which reduce radiation and insure against frequency shift with line voltage fluctuations.

The OA2 stabilizes the oscillator supply voltage at 150 and helps to keep the frequency constant.

To reduce radiation, insert the line filter shown at *a* between the switch and the line cord. L1 and L2 are 20 turns of No. 28 enamelled wire close-wound on a 1/2-inch form. This filter should be enclosed in a well-grounded shield.—Wilbur J. Huntz

TESTER CHECKS FOR DEFECTIVE SELENIUM RECTIFIERS

Defective selenium rectifiers which develop less than normal output voltage often cause loss of sensitivity in broadcast sets and many other types of troubles in TV sets. To assist the service technician in making qualitative measurements on these units, the Rectifier Division of Sarkes Tarzian has released a circuit of a tester for their selenium rectifiers.

Rectifiers are rated by the d.c. voltage which they develop across a large filter capacitor when delivering approximately full-load current. Load resistor R1 is an adjustable, 2,000-ohm, 25-watt unit tapped at 1,750 and 1,300 ohms; R2 is 1,000 ohms, 50 watts, tapped at

850, 650, and 520 ohms; and R3 is 500 ohms, 100 watts, tapped at 430, 375, and 290 ohms. A 2-circuit, 9-position, non-shorting switch selects the required load resistor and filter capacitor.

To operate the tester:

1. Make sure that S1 is OFF, then plug the rectifier into the receptacle. Be sure that polarity is correct.
2. Set the selector (S2) to the correct position for the rectifier being tested.
3. Throw S1 to ON.
4. Reject all rectifiers which, within 5 minutes from the time the voltage is applied, do not deliver the approximate voltages listed in the following table:

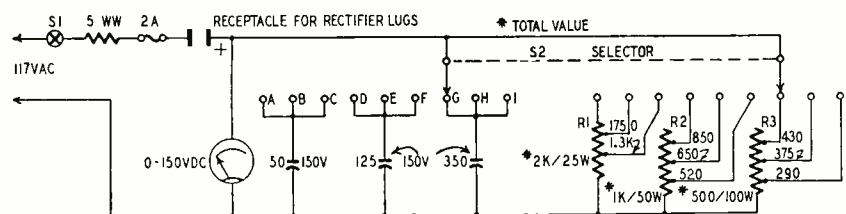

Rectifier Model No.	Selector Setting	D.C. Volts (Approximate)
65 (65 ma)	A	130
75 (75 ma)	B	130
100 (100 ma)	C	125
150 (150 ma)	D	130
200 (200 ma)	E	130
250 (250 ma)	F	130
300 (300 ma)	G	125
350 (350 ma)	H	125
450 (450 ma)	I	120

SQUARE-WAVE GENERATOR

When time is an important factor, use a square-wave generator and scope instead of a variable-frequency oscillator and voltmeter for checking the response of audio and video amplifiers. The latter method gives the true response curve which is more easily interpreted, but it takes too long to plot curves when comparative checks are made on several amplifiers or when cut-and-try methods are used to select components which give the desired response curve. A square-wave generator and oscilloscope are the ideal tools for making rapid measurements.

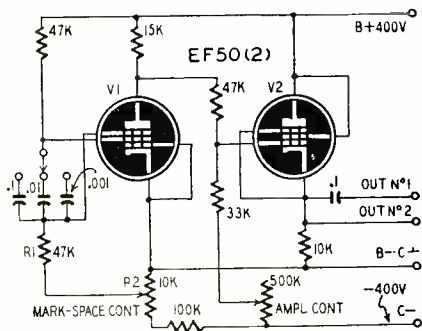

Described in *Wireless World* (London) is a simple generator which provides square waves at 80, 800, and 8,000 cycles with output variable from zero to 50 volts peak-to-peak. The circuit shown in the diagram is simpler than the usual multivibrator-type square-wave generator or the clipping and clamping circuits used to convert sine-wave voltages into square waves.

The negative half-cycles at the plate of the transistron oscillator V1 are distorted, so a combined triode limiter and cathode-follower V2 is used to clip the negative half-cycle and provide a low-impedance output of approximately 150 ohms. The 10,000-ohm control varies the mark-space ratio from approximately 5 to 1 at one extreme to about 1 to 3 at the other. This control affects the repetition rate so the frequencies of 80, 800, and 8,000 cycles are correct only when the mark-space control is set for producing a perfect square wave. The frequency is continuously variable within each range when R1 is replaced with a variable control. When R1 is variable it interacts with R2 so calibrations do not hold.

The original constructor used EF50's. These are readily available on the surplus market but the special 9-pin lock-in sockets they require are hard to find. You can substitute a 6AB7, 7V7, 7W7, or any similar pentode for V1 and one



THE ONE VOLUME FOR EVERY PRACTICAL RADIO MAN

THE WORLD'S MOST VALUABLE REFERENCE WORK FOR RADIO MEN, FROM ADVANCED AMATEURS TO TV and RADIO TECHNICIANS

New, Giant Thirteenth Edition-

RADIO HANDBOOK

For Practical Radio Men:

How to design, construct and operate standard types of radio transmitting and receiving equipment . . . both at standard frequencies and in the v-hf range. Information you must have where you can find it quickly . . . now in a complete one-volume library, the RADIO HANDBOOK!

For Radio Technicians:

Reference data galore, the latest in theory and practice, and a wealth of information on the operation of vacuum tubes as amplifiers in all frequency ranges. Profusely indexed for easy finding, clearly illustrated and described for easy reading, all within easy reach for owners of this one-volume RADIO HANDBOOK!

For Advanced Amateurs:

In addition to all this, you'll find new information on simplified TVI-proofing, bandswitching fixed-station and mobile transmitters, a remotely-tuned v.f.o. for mobile or fixed-station use, and a multitude of new ideas and suggestions for improved operation. Also, more study material has been added to help you obtain your first licenses, or a higher class of amateur or commercial license . . . it's all in the new RADIO HANDBOOK!

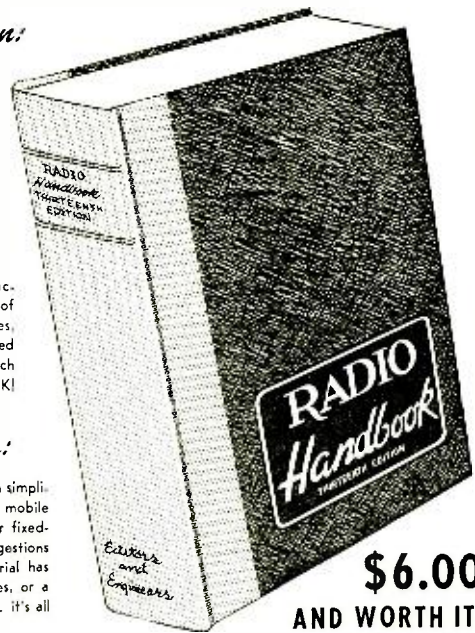

\$6.00 AND WORTH IT!

You can't afford to be without this beautifully bound one-volume "encyclopedia of radio information" . . . the largest RADIO HANDBOOK ever published . . . 736 pages of vital information . . . at a cost of less than one cent per page!

BY MAIL FROM US, \$6.25 in U.S.A. FOREIGN ORDERS, \$6.50

ORDER NOW!

AT YOUR FAVORITE DEALER or direct by mail from
Editors and Engineers 1305 KENWOOD ROAD Santa Barbara CALIFORNIA

NEW CONDENSER TESTER



Finds Intermittent Condensers Instantly

Pres-probe's sliding tip with variable resistance prevents condenser heating. Tests with power on. Requires no adjustment. Stops guesswork. Saves time. Convenient probe size (7 1/2" long). Satisfaction guaranteed.



See Your Dist. or Order Direct

PRES-PROBE CO.

2326 N. THIRD ST., MILWAUKEE 12, WIS.

big FREE GIFT offer

SEE PAGE

15

BARGAINS AT HUDSON

**HIGH FIDELITY
BRITISH
8" PM SPEAKER**

LIMITED QUANTITY **\$895**
No. S-1557

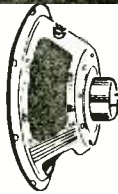

25-13,000 cps! Superb 8" PM Speaker outperforms most 12" speakers - Sensationally Priced! All Brand New and Perfect! Use two or more of these to achieve the finest high fidelity reproduction. Ideal for phono, TV, etc. where space is limited and high power is not required. Very High Efficiency, Beautifully Built.

FAMOUS MAKE RADIOS

3-WAY-3-BAND, AC-DC-BATTERY PORTABLE
Terrific Value! Built-in loop and collapsible fish-pole antennas, leatherette case. Powerful performance! Tuners: 16.7-5.45 Mc, 5.45-2.0 Mc, 1600-540 Kc. No. A5403, Less Batteries.
In Lots of 3.....Each **\$41.98**
Single Units, Each \$44.27

3-WAY, AC-DC BATTERY PORTABLE
Compact, Efficient, Handsome! Covers entire broadcast band. Amazing Sensitivity! 4 tube superhet in modern plastic case, bronze grille. Weighs 6 lbs. with batteries. No. A5404, Less Batteries.
In Lots of 3.....Each **\$22.95**
Single Units, Each \$24.09
Burgess XX-45 "B" Battery, No. 19410.....\$1.82

AM-FM TABLE MODEL RADIO
Big Saving! World-Famous Mfr. Made to sell for almost DOUBLE! 8 tubes. Remarkable fidelity, Easy Tuning, Tone Control. Built-in AM and FM antennas. Limited Quantity! No. A5400,
In Lots of 3.....Each **\$40.15**
Single Units, Each \$42.35

WILCOX-GAY DISC and TAPE RECORDER-PHONO. Portable. List Price \$187.50. Sensational Value. No. A19901. In Lots of 3, Each **\$131.25**
Single Units, Each \$150.00



FREE
Send Penny Postal Card to Get Our Catalogs and Regular Literature!

212 Fulton Street, New York 7, N. Y.
Dlgy 9-1192 OPEN THURSDAY EVENINGS UNTIL 9 P. M.

*** VOLOMETERS**

MODEL 102

(1000 ohms per volt meter)

- 3" SQUARE METER
- 3 AC CURRENT RANGES (0-30/150/600 ma.)
- Same zero adjustment for both resistance ranges (0-1000 ohms, 0-1 megohms)
- 5 DC & 5 AC Voltage Ranges to 3,000 Volts. Also 4 DC Current Ranges.

\$14.90



MODEL 104

(20,000 ohms per volt meter)

- 4 1/2" SQUARE METER (50 microamperes—Alnico magnet)
- Includes carrying strap
- 5 DC Voltage Ranges to 20,000 ohms/volt to 3,000 V.; 5 AC Voltage Ranges to 3,000 V.; 3 Resistance Ranges to 20 megs. Also 3 AC & DC Current Ranges at 5 DB Ranges.

\$26.35



All of the above have round cornered, bakelite, molded cases. (*Reg. Trade Mark for Volt-Ohm-Milliammeter)
Export Dept. 333 W. 42nd St., N. Y. C.
Write Dept. B-6 for Free Catalog

Gives More Measurement Value Per Dollar



ELECTRONIC MEASUREMENTS CORPORATION

280 Lafayette St., New York 12, N. Y.

section of a 6SN7 or a similar triode for V2.

The unit requires 400 volts of bias and 400 volts on the plates for 50 volts peak-to-peak output. The output is somewhat lower when operating voltages are halved.

PHOTOELECTRIC RELAY

The photoelectric relay shown in the diagram has unusual characteristics which make it useful for many applications. It can be made to perform as follows:

1. Open or close an external circuit and hold it in that position until the relay is reset by the operator.
2. Operate as a high-speed photoelectric relay for counting, signaling, or control purposes.
3. Open or close an external circuit for a predetermined interval which is not controlled by the light source.

To operate the unit as a locking-type relay as in No. 1 above, advance the sensitivity control until the relay just closes, then back off the control just a hair.

For normal high-speed operation, advance the control slightly beyond the point where the relay pulls in. Touch-up the adjustment and vary the

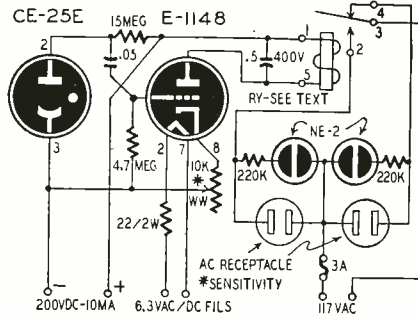

strength of the light source for reliable operation at high speeds.

To operate the unit as a light-triggered time-delay relay, advance the sensitivity control well beyond the point where the relay pulls in. When light strikes the phototube, the relay opens for a few seconds and then closes again. The cycle repeats when the light is momentarily interrupted. The duration of the timed cycle depends on the setting of the sensitivity control and the intensity of the light beam which strikes the photo tube.

All components in the relay unit are available on the surplus market. The photo-tube is a CE-25E which is electrically equivalent to the 927 and 1P32. The control tube is a surplus E-1148 which is equivalent to the HY615. Any s.p.d.t. d.e. relay having a coil of 6,000 ohms or more can be used. Tiny neon lamps are connected across the a.c. outlets to serve as indicators showing whether the relay is in an energised or unenergised state.

A special socket is required for the CE-25E. You can make one from a miniature 7-pin socket. Remove the metal pin inserts and ream holes 1, 4, and 7 for a snug fit on the pins of the CE-25E. Solder the circuit wires directly to the base pins on the tube.—

O. C. Vidden

—end—

NOW IN BOOK FORM

John T. Frye's easy-reading series on the fundamentals of radio servicing!

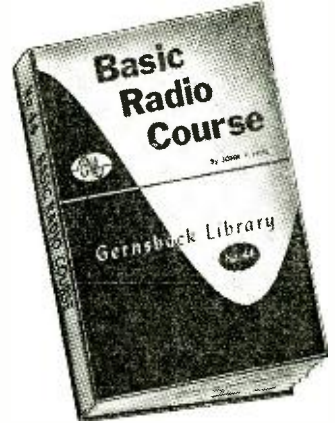

Only \$2.25

176 Pages, 130 Illustrations
First Gernsback Library Book with Durable cloth bound cover!

Do fundamentals give you a headache? Does theory throw you? Then, BASIC RADIO COURSE is for you! It starts with Ohm's law, then takes you through the circuits of a modern radio set and tells you how and why they work. It's actually a pleasure to read because the author believes learning should be fun. He talks the service technician's language and isn't afraid to make you smile once in awhile. But BASIC RADIO COURSE doesn't skimp on facts. It gives you all the technical information you'll find in a higher priced book. The only difference is, you'll enjoy reading it and you'll save money.

PUBLISHED BY REQUEST

Basic Radio Course was published at the request of many radio men who read, enjoyed and learned from John Frye's series on the fundamentals of radio servicing which concluded only recently in RADIO-ELECTRONICS. It can help the experienced technician as well as the beginner. Order your copy today.

TWENTY-SIX CHAPTERS

The Electron Theory • Ohm's Law and the Resistor • What is Induction? • Capacitance • How Capacitors are Made • Reactance, Impedance and Phase • Resonant Circuits • Transformers—How They Work • The Diode Vacuum Tube • Triode and Tetrode Tubes • The Pentode Vacuum Tube • Vacuum Tube Characteristics • The Power Supply • Power Supply Types • Sound and Loudspeakers • The Power Output Stage • The Voltage Amplifier • Demodulating the R. F. • Receiver Selectivity • The Converter Stage • Some Oscillator Circuits • How to Trap a Signal • Signals in Space • Receiver Refinements • Instruments and Tools • The Service Technique.

Order your copy from your distributor or MAIL THIS COUPON TODAY

Radcrafft Publications, Inc., Dept. 61
25 West Broadway
New York 7, N. Y.
My remittance for \$2.25 is enclosed. Please send me a copy of BASIC RADIO COURSE postpaid.

NAME _____
STREET _____
CITY _____ ZONE _____ STATE _____

TV BALLAST TUBE

Clarostat Mfg. Co., Inc., Dover, N. H., announces a new TV ballast replacement for Pilot Radio, Type 35-37. This is one of the Clarostat plug-in tube-type wire-wound resistors which are avail-

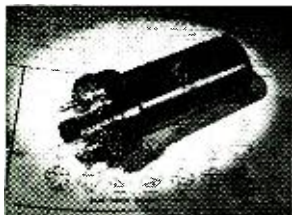

able in some 75 standard numbers for exact-duplicate replacements, and in 10 Universal numbers representing a minimum inventory that can take care of upward of 85% of replacement calls.

PA MICROPHONE

Electro-Voice, Inc., Buchanan, Mich., introduces the model 636 Slimair microphone for PA work. It is 1-1/16 inch in diameter and 10 inches long. The



grille head is acoustically designed to prevent wind and breath blasts, and outdoor pickup is free from wind rumble. Bass response extends to 60 cycles and treble goes up to 13 kc.

The omnidirectional polar pattern becomes somewhat directional at high frequencies. A swivel head permits vertical tilt for aiming at sound source. Stand coupler has a standard 3/8 inch 27 thread, and the case is made of brass and finished in satin chrome or ebony black. On off switch is optional.

PROBING TWEEZERS

Hytron Radio & Electronics Corp., Salem, Mass., is distributing plastic probing tweezers to the radio service trade.

With the set turned on, these probing tweezers probe, grasp, and manipulate suspected wiring and components to make it easier to ferret out intermitments, shorts, opens, feedback from adjacent wiring, etc. The operator is free from the danger of shocks and shorts.

The jaws of the tweezers have coarse and fine serrations for grasping different sizes of wire, resistors, etc. They are made of high-dielectric polystyrene to minimize capacitive detuning.

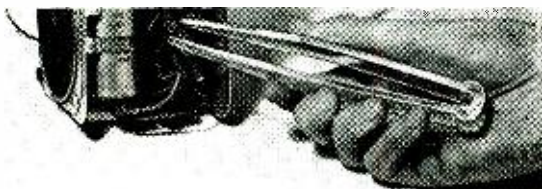

H. V. CAPACITOR

Sprague Electric Products Co., North Adams, Mass., has developed a new 500- μ mf, 15,000-volt ceramic capacitor consisting of a ceramic slug encased in a sturdy molded rubber jacket. Known as the type 510C1, the capacitor is rated for continuous operation at 85° C. and will withstand a 22,500-volt dielectric test. Its minimum insulation resistance is 10,000 megohms.

The composition of the special rubber jacket is such that it will withstand a corona atmosphere without physical deterioration. In addition, the rubber compound used is equal or superior to neoprene in its resistance to combustion. A self-grommet permits easy mounting in chassis. Capacitance and voltage rating markings are molded into the black rubber body.



ELECTROLYTICS

Illinois Condenser Co., 1616 North Throop St., Chicago, Ill., offers an improved line of plug-in and twist-prong electrolytic capacitors to meet JAN and commercial specifications. They feature a phenolic molded cap structure

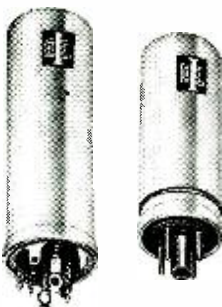

that hermetically seals the container so that these units can be used under the most difficult conditions, from marine operations to stratosphere use. They are not affected by sudden temperature or pressure changes, and can withstand wide temperature ranges. Available with both high- and low-voltage ratings, they meet all Navy, Army and Air Force requirements.

V.H.F. TRANSMITTER TUBE



General Electric Co., Tube Division, Schenectady, N. Y., offers a new power tube for TV and FM transmitters. De-

signed for use as a grounded-grid class B or class C r.f. amplifier or as an oscillator, the GL-6039 has a water-cooled anode and a cathode with a thoriated tungsten filament, and can dissipate 7 kw. A pair of these tubes will put out 10 kw in TV service and 25 kw in FM. Neutralization is not necessary in a properly designed circuit, and the tube features low lead inductance, large terminal contact area, and silver-plated metal parts to reduce r.f. losses.

CRYSTAL MICROPHONE

Turner Co., 900 17th Street, N.E., Cedar Rapids, Ia., announces model 60X crystal microphone for hand, desk, or stand use. Response is 70 to 7,000 cycles and sensitivity is 52 db. below 1 volt/dyne/sq. cm. The case is finished with a baked-on beige wrinkle-finish enamel, and the microphone is furnished com-



plete with 6-foot cable and stand adapter. Available with on-off slide switch.

TEST OSCILLATOR

Triplet Electrical Instrument Co., Bluffton, Ohio, is marketing a new wide-range test oscillator, model 3432. Five fundamental ranges cover from 165 kc to 40 mc, and two harmonic ranges cover from 36 to 120 mc. Each range has its own easily read scale. An r.f. selector provides high and low output, and an output attenuator provides fine control of the output. Internal modulation is variable from 0 to 100%, at 400 cycles. External modulation may



be applied. All audio and r.f. circuits are doubly shielded with copper-plated steel shields. The black enamel metal case measures 15 11/32 x 11 1/32 x 6 1/4 inches and has a strap for carrying.

H. V. TRANSFORMER

Radio Corp. of America, Tube Dept., Harrison, N. J., has a new horizontal-deflection-outout and high-voltage transformer, 225T1, for use with picture tubes having a deflection angle of about 66°. It provides omnib deflection with a single driver tube and requires only a single high-voltage rectifier tube. In properly designed circuits, the transformer can supply up to 16 kv at

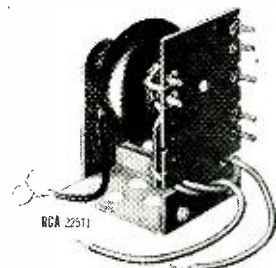

no load, has good regulation, and provides good deflection linearity. The 225T1 uses a ferrite core for high efficiency and compactness. It is designed to match a 209D1 yoke.

MULTIMETER

Electronic Instrument Co., 276 Newport St., Brooklyn, N. Y., is releasing its new 20,000 ohms/volt multimeter EICO model 555. Available either in kit form or factory wired, the instrument has 31 ranges. The 4 1/2 inch meter has a 50- μ a movement. All resistors have 1% or better accuracy. The case is high-impact bakelite with all figures and symbols imbedded for long wear.

Ranges: d.c. voltage: 0-2.5, 10, 50, 250, 1,000, 5,000, at 20,000 ohms/volt. A.c. voltage: same ranges, at 1,000 ohms/volt. Output voltage: same ranges, with 0.1- μ f internal series capacitor. Decibels: -12 db to +55 db, in 5 ranges. D.c. resistance: R x 1, R x 100, R x 10,000. D.c. current: 0-100 μ a, 10 ma, 100 ma, 500 ma, 10 amp. (250 millivolts). D.c. accuracy: 3% of full scale. A.c. accuracy: 5% of full scale on all ranges.



FLYBACK TRANSFORMER

RAM Electronics, Inc., Irvington-on-Hudson, N. Y., announces a new high-efficiency flyback transformer for replacement and conversion purposes. The XO45 is designed for all receivers originally using 1B3-G or 6B6-G tubes. It generates 12.5 to 14 kv for 16- to 20-inch round or rectangular tubes, with horizontal sweep more than ample for 20-inch picture tubes. Both regulation and linearity are good.

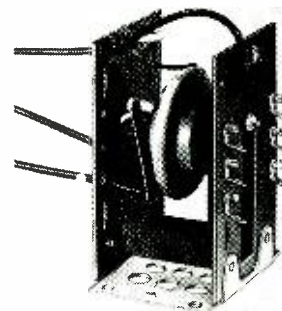

DEFLECTION YOKE

Allen B. Du Mont Laboratories, Inc., Electronic Parts Division, East Paterson, N. J., presents the series Y2A distributed winding deflection yoke—designed for edge-to-edge sharp focus—for 60 to 70-degree deflection picture tubes.

The Y2A deflection yoke is available for use with transformer or auto-transformer output circuits and with different networks and lead lengths, or without networks and leads. In several standard stock types, it covers the needs of service technicians and set owners for improving existing equipment. For the service trade, the yokes come packed in the individual boxes with installation instructions.

Rugged in mechanical design, the yoke can withstand continuous operating temperatures up to 90° C., and voltages up to 4 kv between any windings or between windings and frame. Standard horizontal inductance is 10.5 millihenries, and vertical inductance 42 millihenries.

SCOPE CALIBRATOR

Tensor Electric Development Co., 343 Classon Ave., Brooklyn, N. Y., introduces its model A-42F oscilloscope calibrator. It permits monitoring the amplitude of a signal or any part of a signal on an oscilloscope screen. Voltages as low as 0.5 mv and as high as



100 v r.m.s. can be measured. The signal to be measured is connected to the input of the calibrator, and the calibrator output feeds the scope. The calibrator is set to give an image that is just larger than that of the test signal, and the amplitude is read on the calibrator meter. The meter scale is calibrated in r.m.s., peak-to-peak, and voltage db above 1 volt. The calibrator output is a 60-cycle sine wave with an accuracy of 5% from .0005 to 100 volts r.m.s.

TV ANTENNA

Technical Appliance Corp., Sherburne, N. Y., is marketing a new antenna called the Taco Special Twin-Driven Yagi which is designed to cut out most co-channel interference. Average front-to-back ratio over the 6-mc bandwidth of the channel for which it is tuned is 30 db. Terminal impedance is 300 ohms. Mechanically the new antenna is similar to the regular Taco twin-driven Yagi. Available for any of the low bands, the Special may be used as a single antenna, or as a stacked array. Elements are a director, two driven elements, and a reflector.

CALIBRATED POT

Chicago Industrial Instrument Co., 536 W. Elm St., Chicago, Ill., is offering a new precision potentiometer.

The Selectohm is a new accurately calibrated 0-to-100,000-ohm linear potentiometer for use as a resistance substitute for service or laboratory



work. It provides a fast means for determining the values of blackened burned-out resistors when it is substituted in radio, television, and other electronic circuits.

The new units is also useful for laboratory work and may be used to replace a decade box. The Selectohm serves as a precision rheostat, shunt, or multiplier. It is rated at 25 watts.

TV INSTALLATION KITS

Insuline Corp. of America, Long Island City, N. Y., is distributing a series of eight television antenna installation kits, designed to meet practically all receiving requirements in either primary service or fringe areas. The simplest kit contains a single conical aerial, a 5-foot steel mast, and 50 feet of lead-in wire. The others are progressively more elaborate, the largest kit containing a stacked conical aerial, 10-foot mast, base mount, guy wire, 100 feet of lead-in, lightning arrester, clamps, insulators, etc.

R-C OSCILLATOR

Southwestern Industrial Electronics Co., 2831 Post Oak Road, Houston, Tex., announces a new precision oscillator.

The model M-2 oscillator covers a range of 1 to 120,000 cycles in five bands. The circuit is an improved version of a bridge stabilized type oscillator which affords a means of reducing to a minimum the influence of amplifier parameters on the frequency of oscillation. The dial is calibrated to within 1 1/2% plus 0.1 c.p.s. One of the two output circuits provides from 0 to 20 volts r.m.s. to a 1,000-ohm load, and the other provides from 0 to 1 volts into a 300-ohm load.

Harmonic distortion is less than 2% within the audio range.

An electronically regulated power supply provides plate current for all stages, and deposited-carbon resistors



are used in the frequency-determining networks. Power consumption is 125 watts at 115 volts, 60 cycles. Dimensions are 9 3/4 inches high, 18 1/2 inches long, and 12 inches deep. Weight is 43.5 pounds.

VIDEO AMPLIFIER

Ripley Co., P.O. Box 31, Middletown, Conn., presents a new video amplifier.

Having a gain of 1000, the frequency response of this amplifier is flat from 15 c.p.s. to 4 mc within 1.5 db of the 10-kc response point. A cathode-follower input stage is used for circuit isolation and includes an input attenuator providing 1:1, 1:10 and 1:100 attenuation ratios as indicated by a control knob on the front panel. The input impedance, without probe, is approximately 2.2 megohms and 40 μ ft on all attenuator ranges.

A gain control is provided for adjusting the output from 0 to 50 volts r.m.s. A signal-polarity switch on the front panel varies the cathode bias so that the amplifier unit may be adjusted for



optimum performance regardless of the polarity of the input signal. Phase shift is minimized to provide satisfactory reproduction of pulses on the order of .1 microsecond and of square waves at repetition rates as low as 100 per second.

TUBE TESTER

Triplet Electrical Instrument Co., Bluffton, Ohio, announces a new tester.

Model 3413-A has flexible 3-position lever switches for complete coverage of present and future tube connections. RMA pin numbering of tube element levers makes for quick reference of tube base connections. Illuminated, easy-to-read roll type tube chart is built into the tester. Simplified test procedure makes it possible for the user to add new tube data to the chart when desired.

Line-voltage indication on center of meter dial permits observation and adjustment for line fluctuations. Filament voltage: 0.63 volts to 110 volts in 14 steps.

The large 6-inch meter has a 3-color easy-to-read 6000- γ -BAD scale.

Portable metal case, 15-11/32 x 11-1/32 x 6-1/8 inches, is of black satin wrinkle finish, and has removable, hinged cover and leather handle.

ALIGNMENT TOOL KIT

JFD Manufacturing Co., 6101-23 Sixteenth Ave., Brooklyn, N. Y., introduces a new alignment tool kit No. TK60. It contains six alignment tools made of molded nylon. Each tool has two different tuning tips, one on each end. Made in contrasting colors for quick identification, the tools are packed in a handy plastic case.

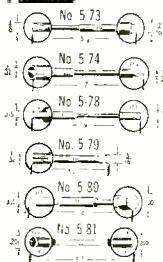

Servicing adjustments provided by the tools are: No. 5-73 for tuners, trimmers, and i.f. transformers; No. 5-74, for midget transformers; No. 5-78, for nested iron cores; No. 5-79, for close trimmer and i.f. transformers; No. 5-80, for K-tran and i.f. transformers; No. 5-81, tuning rod for changing coil inductance.

24-HOUR TAPE RECORDER

Amplifier Corp. of America, 398 Broadway, New York, N. Y., is introducing the Magmaster model 550-B, a 24-hour reference recorder designed for continuous recording of airport plane-to-control tower conversations, continuous telephone monitoring, and all other applications requiring unattended, continuous, round-the-clock recording and playback.

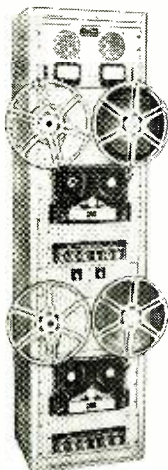

The instrument has two complete recording-playback systems, each of which operates continuously for 12 hours at a tape speed of 3 inches per second using a 1 1/2-inch diameter reel containing 6,000 feet of standard 1/4-inch recording tape. After two tracks have been recorded or played on one reel, a relay sets the other reel into operation. By changing the reel at any time during the 12-hour interval, continuous play for extended periods is attained.

Frequency response of the over-all system is 50 to 4,500 cycles \pm 3 db. Dynamic range is 40 db. Input impedances are 500 ohms for recording of telephone lines, and 200 and 50 ohms for microphone line recording. Output impedances are 3-2 and 500 ohms for playback through external speakers or into a telephone line. Amplitude variation at 1,000 cycles is less than 0.75 db. Power output through the built-in playback amplifier is 5 watts, with facilities provided for higher power using external amplification.

ANTENNA HARDWARE

Industrial Precision Products Co., 315 N. Hoyne Ave., Chicago, Ill., announces a new line of antenna hardware which features some heavy riveted construction.

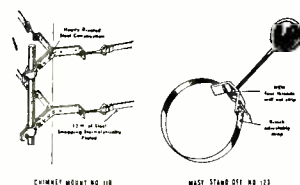

tion for chimney and wall mounts, and mast standoffs made with a deep extrusion to accommodate four or more threads to prevent stripping.

SOLDERING GUN

Phillips Manufacturing Co., Inc., Minneapolis, Minn., offers a new soldering gun. The Versa-Tool combines heating element, transformer, light, two-position switch and fuse into a single unit. Its four interchangeable tips of rigid construction enable the operator to unsolder old work by exerting tip pres-



sure with the heating element on. The two-position, trigger-actuated switch in the first position closes the circuit to a concentrated light beam, set at an angle to eliminate shadows. This position enables the operator to use the tool as a flashlight. The second position maintains the light circuit and closes the heating element circuit. Both transformer and basic circuit are protected by a fuse, and the carbon element is replaceable.

WEATHERPROOF DRIVER UNIT

Racon Electric Co., 52 East 19th St., New York, N. Y., announces a new driver unit. The model PM-708TR features a built-in 25-watt, vacuum integrated, line-matching transformer with available impedances of 15, 500, 1,000, 1,500, and 2,000 ohms.



The voice coil is wound of aluminum wire and the lead terminals are welded. The voice-coil lead is a strip of fatigue-resistant beryllium copper, and the voice-coil suspension is Bakelized linen cemented to the phenolic diaphragm with thermosetting plastic.

This driver unit has a 75-100% overload capacity, is completely waterproof and tropicalized, and has combined solder lug and binding post terminals.

TEST EQUIPMENT LINE

Precision Apparatus Co., 92-27 Horace Harding Blvd., Elmhurst, L.I., announces to the service trade a new moderately priced, matched-panel-mounting test instrument combination, available complete or in separate units. This new combination includes the series E-200C-PM signal and marker generator, the series 10-12-PM Electronic tube master and battery tester, series E-400-PM sweep signal generator—all three mounted in standard matching panels. Also included in this set are the new Precision EV-20 zero-center vacuum-tube voltmeter and multirange test set, and the series ES-500 5-inch wide-range, high-sensitivity portable oscilloscope.

—end—

The Radioman's Wife Puts in A Good Word

By MRS. ROBERT E. ALTOMARE

Every time I try to dun my husband for money for a new hat, or a coat, or any similar necessary appurtenances to feminine happiness, I'm always met with, "If you need extra money why don't you write an article?"

"Why not?" quoth I, and add with some ascerbity, "On what?"

To which said husband, being a radioman, replies in great surprize at my stupidity, "On radio, of course."

Whether this will net me a new bonnet or not, it looks like a good way to air my many and uncomplimentary views on the subject.

LET'S get one little matter straight for the record right now. I do not now, nor from the looks of things, will I ever, "see" radio.

Little facts such as expecting a new rug from carefully nurtured savings and having hubby gleefully exhibit a "bridge" purchased from same are just the sort of things that could have curdled my enthusiasm, but I doubt it. It had to be much more than that.

For instance: At a gay gathering where husbands and beaus are do-si-do'ing and swinging their ladies with great good will, if I happen to spy some wistful creature sitting alone with her hands clasped quietly in her lap, I can usually start out on the right conversational foot by asking, "And what branch of radio is your husband's hobby?"

When I see some frail female up on a housetop battling a stiff wind while

she nails down the flapping shingles, I just look beyond her for the short-wave antenna that's sure to be in the back yard.

One girl I know spends her evenings sitting on the basement stairs talking to her husband and knitting, and, incidentally, accumulating callouses since there is never room for a chair among the radio paraphernalia. Hers is an extreme case, of course. The only reason her husband can still talk is that he is only a *student* radioman. Not full-fledged, you see!

Whenever I hear a woman speak of her "two lovely children" and then, laughing resignedly add, "But of course, I really expected a larger family." I can get a reputation for being psychic simply by asking whether her husband does experimental radio work or transmitting.

Now this observation may seem a



"One girl spends her evenings sitting on the basement stairs . . . and knitting."



to Radio-TV Service Technicians
FREE

the new fact-packed
PF INDEX!
(PHOTOFACT INDEX AND TECHNICAL DIGEST)

- ★ Each issue packed with authoritative articles on TV, Radio, latest servicing techniques
- ★ Latest complete Index to PHOTOFACT, world's finest service data

Don't miss a single issue! Be sure to get your PF INDEX—the valuable new publication you'll read from cover to cover—and use at your bench every working day.

PF INDEX brings you complete, fully illustrated discussions of latest developments in Radio and TV. Keeps you up-to-date on new circuit designs, latest testing methods, time-saving repair techniques, good shop practices—helps you operate a better, more profitable business.

Have all this practical, authoritative information plus the complete Index to PHOTOFACT Folders—the quick reference guide to the world's finest service data. PF INDEX is worth dollars to you—and costs you nothing. Get your FREE copy today!

Ask Your Jobber for It!

HOWARD W. SAMS & CO., INC.

Get the current PF Index from your Parts Jobber, or write us direct on your letterhead (or enclose business card). Address: Howard W. Sams & Co., Inc., 2201 E. 46th St., Indianapolis 5, Ind.

FREE

Send FREE copy of the current PF Index

Name.....

Address.....

City.....State.....

**GET RID
OF
B. O.***



**in TV Pictures!
* BARKHAUSEN OSCILLATION**

When *vertical black bars* appear in TV pictures as shown above they are the result of *Barkhausen Oscillation* occurring in the horizontal sweep output tube (such as the 25BQ6, 6BQ6, 6EV5, 25EV5, 6AU5 or 25AU5 etc.). To correct this difficulty our engineers have developed the

**PERFECTION
B. O. ELIMINATOR**



**B. O. ELIMINATOR
(Actual Size)**

This compact device fits over the horizontal sweep output tube and because it brings a concentrated magnetic field near the source of the Barkhausen Oscillation—namely the screen grid—it usually eliminates the oscillation



**EASY
TO INSTALL**

Just slip the B. O. Eliminator over the tube, move down, or up, or turn until the dark vertical bars disappear from the picture. Spring grip holds the Eliminator in place.

and the black lines on the face of the picture tube. . . . Service men who have used the B. O. Eliminator say it is the simplest and most positive method of getting rid of the vertical bars that they have ever known. They see a big demand by service men in maintaining the 10,000,000 TV sets now on the market.

Order Today From Your Supplier!

PERFECTION ELECTRIC CO.
2645 South Wabash Avenue Chicago 16, Illinois
Makers of Perfection Speakers, Ion Traps and BeamJuster TV Picture Centering Controls

**AMERICA'S most advanced
Tape Recorders**

**the TWIN-
TRAX
SERIES**

models for —> professional
—> semi-professional
... and —> experimental use

WRITE TODAY for 12-page 1951 catalog. Fully illustrated, containing complete technical specifications and direct factory prices.

AMPLIFIER CORP. of AMERICA
398-7 Broadway, New York 13, N. Y.

backhanded slight of radio's manhood but you'll have to admit that the real "ham" generally gets up at 5:30 am to talk to Timbuctoo, recognizes his

a certain amount of patriotic excur-sioning toward increasing the popula-tion that dwindled due to the war, the enticing things we girls heard around



"All those boxes you have to climb over before you can open up the studio couch."

status as pater familias by putting in eight grudging hours at some job, then rushes from the supper table to spend the rest of the evening talking to Ootcutbit, which is Timbuctoo spelled backward and pretty much the way that shortwave sounds to me.

If, however, the husband is only interested in experimental radio work, then he sleeps to the last possible moment—any morning—so that he will have long, reasonably fresh evening

the lockers during the second year of high was not the type of activity that would engage the interest of the real radioman and we radiowives would simply have dismissed such ideas along with those about the Easter bunny and the birds and bees.

Where to find the shack

"Shack" is a word of many strange and varied meanings. If you live in a one-room affair with your radio



"I've learned to swing a pretty neat hacksaw, but even there I get stymied."

hours to "try" things in his shop.

Except for the weaker mind and backsliding of the radio novice and

husband, then it is all those boxes of stuff you have to climb over before you can open up the studio couch.

If you live in two rooms, "shack" is the three-fourths of the dining table that you can no longer eat off.

If you live in a house, the shack is the space designated on the plans or by the real estate agent as "laundry" or "lovely recreation room."

In my own case "shack" brings back bitter memories.

My husband always used to refer to me with a certain kindly affection, "My wife? Yeah, she's a pretty nice girl." But one day a girl friend and I were having a heart-to-heart talk about how many times you should rinse the clothes when I mentioned that it was pretty darned hard for me to get any laundry done at all because of all the junk in the basement. Wouldn't you just know that he would hear me? JUNK! His most precious precious!

Well, they say it is the little things in life that really count. Upon such loose name-calling on my part my husband was ready for the divorce courts then and there, when I reminded him of the baby. Nevertheless, he watches his words and thinks twice before he cautiously refers to me as "My wife? Yeah."

But I'm not the type to let these things get me down. Having been the girl voted "most likely to—," I put my thinking cap on and decided that the way to dethrone that radio usurper of my rightful place in the American Home would be to study radio. Yes, I would study radio, and hubby and I would go hand in hand down Life's Lane in Happy Companionship.

If I could persuade my husband to take cooking lessons written in Sanskrit, he'd get an approximate idea of what I went through.

Who in tunket would know that Xmfr was a transformer?

"Measure the c.m. area of the conductors," the experiment read.

"Conductors?" I cried wildly, "There's nothing here but a bunch of wires!"

"Plug in the jack," the instructions said.

"Oh, my gosh, what is a jack?" My experience led me to think of a boy or one of those things you use when you get a flat. Nothing like that here.

"Why is damping necessary?" read the question sheet. Having raised a baby or two, I had a ready answer for that one but it wasn't the answer they wanted.

"And these calipers," said the instructor matter-of-factly, "are hermaphrodites."

"Oh," I gasped, shocked, "not really!"

My lessons are all well surrounded by marginal notes mostly concerned with translating the jargon into standard usage. Actually, I have become so word conscious that I'm a better proof-reader than the school ever had.

A lady is limited

It hasn't all been in vain, though. I've learned to swing a pretty neat hacksaw but even there I get stymied. The comfortable "go to H—" with

NOW AVAILABLE!



DUAL CERAMICS

guaranteed minimum capacities:

CAPACITIES:	PART NUMBER:
2x100 mmf. ±50.—20%	6TMSDT1E Tol. ±50.—20%
2x1000 mmf.	6TMSDD1B
2x1500 mmf.	6TMSDD15C
2x2000 mmf.	6TMSDD2C
2x2500 mmf.	6TMSDD25C
2x3000 mmf.	8TMSDD3C
2x4000 mmf.	8TMSDD4C
2x10,000 mmf.	8TMSDS1C

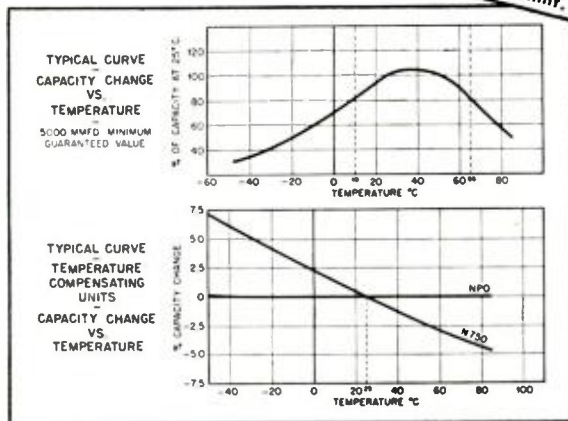

- Small • Space-saving
- Lightweight • Ideal capacitor construction
- Low inductance • Stable, dependable performance • Fully insulated • Capacity clearly stamped in mmf. for capacities under 1000 mmf., and in mfd. for capacities of 1000 mmf. (.001 mfd.) and over.

Order C-D Dual Ceramics from your Cornell-Dubilier jobber today. Write for catalog. CORNELL-DUBILIER ELECTRIC CORPORATION, South Plainfield, New Jersey.

OTHER PLANTS IN New Bedford, Cambridge and Worcester, Mass.; Providence, R. I.; Indianapolis, Ind., and subsidiary, The Rodiort Corp., Cleveland, Ohio.



SEE YOUR LOCAL CLASSIFIED TELEPHONE DIRECTORY FOR NEAREST C-D JOBBER.

RHOMBIC TV ANTENNA OUTPERFORMS ALL OTHER TYPES

THIS IS A BASIC ENGINEERING FACT

- Extremely high gain—power gains of 100 or more
- Broad band for maximum performance on all channels
- High front to back ratio results in minimum interference

ALL THE MOST WANTED FEATURES IN A TV ANTENNA BUT YOU CANNOT BUY ONE

SECOND PRINTING NOW AVAILABLE

To have the TV antenno that outperforms all other types you must build your own
Order Your Rhombic TV Antenna Book Today

- Complete building instructions for 24 sizes
- Easy to read drawings
- Servicemen increase your income building Rhombic TV Antennas for your customers
- Complete information on stocked Rhombics
- Uses easy to obtain materials

TO RICHARD J. BUCHAN WOTJF BRICELYN, MINNESOTA

Send Rhombic TV Antenna Booklet
Enclosed find \$1.50 CASH CHECK MO
MAIL TO
NAME
ADDRESS
CITY

Use coupon **\$1.50** postpaid

EVERYONE WANTS AN "ORIGINAL"



A copy is never as good as the original. That's why TRIO TV Antennas are "wanted" antennas. TRIO has consistently led the industry in developing better, more efficient antennas. Never "just like" another, every new TRIO model is original and represents an improvement over any existing TV antenna.

*MODEL 445, the famous Single-bay TRIO Yagi for TV channels 4 & 5. Supplied less mast and transmission line.

*Patent Pending — No licensing arrangements granted for duplicating principle of this antenna.

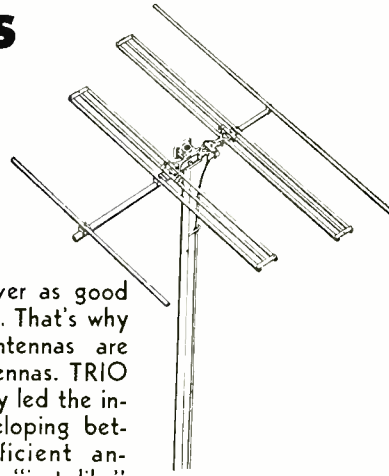

TRIO YAGI SETS THE PACE

An example of TRIO's original design is the amazing dual channel TRIO Yagi — a single-bay 4 element yagi that provides full 10 DB gain on two channels! Available for channels 4-5 and 7-9, this revolutionary antenna makes bulky stacked arrays obsolete by providing excellent fringe area TV reception where other antennas fail!

HOW IT WORKS

Antenna consists of 4 elements whose function is different on the two channels. For example: in Model 445, the elements, on channel 4, act as reflector, dipole, director, director, in that order; while on channel 5, the same elements act as reflector, reflector, dipole and director. Careful design insures proper impedance match with standard 300 ohm lead.

COMPARE THESE ADVANTAGES

- Provides gain on both channels 4 and 5 (or 7 and 9) Equal to Any Two conventional 4-element yagis!
- One bay replaces bulky stacked array!
- One lead replaces old-style 2-lead systems!
- Less weight-per-gain than any other TV antenna!
- Greatly reduced installation costs for complete TV coverage!
- Can be stacked for additional gain.

Model 445. Single or stacked Yagi for Channels 4 & 5.

Model 479. Single or stacked Yagi for Channels 7 & 9.

Model 645. "Controlled Pattern" System consisting of 2 bays offset stacked and "Phasitron." Eliminates co-channel interference. For Channels 4 & 5.

Model 679. "Controlled Pattern" System for Channels 7 & 9.

Model 304. Single Channel Yagi with Double Dipole for Channels 2 to 13.

Model 604. Same as Model 645 except for single channel operation.



Career training in minimum time!

RADIO-TELEVISION ELECTRONICS ENGINEERING

The Electronics industry needs trained technicians now, when military and civilian demands are greater than ever. Graduates of GREI residence school are preferred because of their training and ability. 24 years' experience in professional radio—TV fields; this is a high level technical course requiring average of 20 months to complete.

SEND FOR ILLUSTRATED FREE CATALOG

Get details of Residence course, with survey of job opportunities. Classes start twice a month. Veterans! Training available under GI bill. July 25, 1951 is deadline for most veterans. Act now!

CAPITOL RADIO ENGINEERING INSTITUTE

An accredited technical institute founded in 1927
Dept. 306C 16th & Park Rd. N. W. Wash. 10, D. C.

HELP THE DEFENSE EFFORT

by turning over old copies of RADIO-ELECTRONICS and all other waste paper to paper collecting agencies in your community.

which my husband addresses the material when it slips out of the vise—as it is bound to do in a crucial moment—is denied to me, a woman.

When a woman makes a dress or a cake, she gets all the essentials together in front of her and proceeds from one step to the next to its completion. But not radio!

Take a transformer replacement for instance. You take the old one out and get the new one spaghetted and soldered ready to put in. Since it is the same thing going into the same place with the same parts you'd think you'd be all set for a nice neat job. Are you? Hah! In the first place the lugs are too darned high for the holes so you replace them. Then they don't clear the transformer properly so you have to get the hacksaw and file and do a job on that. Now you find that the screws from the old one are too big for the new transformer. You've got 8-32 and you need 6-40. All the ones in the jar are just a little too short. So off you trot for the electric drill to make the holes in the transformer bigger. Finally you get to mounting the blithering Xmfr and, bless my soul, if the screws aren't too short because of the extra washers you had to use to line it up right! So—to the jar of 6-32's. Now *they're* all too short or too long and have to be filed, *dammit!* And right here I'd like to say that *dammit* is *not* profanity on my part. It is an absolutely necessary part of every full-fledged radioman's equipment. Or his helper's.

Well, it has been an interesting experience, I must say. But I'm afraid that if my husband goes down Radio Lane hand in hand with someone it shall have to be a hand other than mine. I'm quitting while I'm still ignorant instead of insane so—Farewell, dear old radio; Farewell, disheartening struggle with obscure word meanings; Farewell, dull pity in the eyes of lab instructors; Farewell, math formula taken with two aspirins and a glass of water.

Yes, I say, farewell, dear radio, farewell to you!

And after this I guess I'd better. Just wait until His Nihs sees it!

—end—

SIMPLIFIED TV INSTALLATION

When installing a TV antenna on my home, I found it impossible to anchor the lead-in at the correct points on the outside wall. The antenna being mounted on an unused chimney, I decided to bring the transmission line down by the most direct route—straight down the chimney. The lead-in came out through a flue in the basement and was then run along the floor joists and passed through a hole directly under the TV set.

In other installations, the lead-in can be brought out of any convenient fire-place or flue not in use. This method not only simplifies installations, but it also protects the lead-in from damage by heavy ice and snow.—Geo. H. Fieldhouse



THE FUND GOES OVER \$7,900.00

HELP-FREDDIE-WALK FUND

We are happy and proud to announce that the Help-Freddie-Walk Fund this month tops \$7,900.00.

Freddie, as most of our readers know by this time, is the three-year-old son of Herschel Thomason, Arkansas radio technician, who unfortunately was born completely without the vestige of arms or legs.

We are also happy to announce that one of the large circulation magazines—*The Family Circle*—with a total circulation of over 2,500,000 copies a month—became interested in Freddie's misfortune through a reader who had seen articles in RADIO-ELECTRONICS. The editor of *Family Circle* magazine in turn ran a story on Freddie and asked readers to send in contributions to RADIO-ELECTRONICS. These contributions are now coming in in volume and during this month the total collection from this source was \$253.95. We are pleased to list these contributions here:

FAMILY CIRCLE MAGAZINE CONTRIBUTIONS

A Cleveland Friend—Cleveland, O.	\$1.00
A Family Circle Reader—Tacoma, Wash. ..	1.00
A Friend—Millis, Mass.	1.00
A Helper—Ocean City, N. J.	1.00
A Mother—San Diego, Calif.	1.00
A Mother—Pine Plains, N. Y.50
H. Anderson—Vallejo, Calif.	1.00
Anonymous—Chicago, Ill.	5.00
Anonymous—Needham, Mass.	1.00
Anonymous—Yonkers, N. Y.50
Anonymous—Hamilton, O.	1.00
E. Bahns—Pine Plains, N. Y.	1.00
Mr. & Mrs. Wm. Beal—Cincinnati, O.	1.00
Ethel, Albert and Merideth Bloom—Summit, N. J.	5.00
F. Brook—Fort Worth, Tex.	5.00
Mrs. Margaret Brown—Berkeley, Calif.	3.00
Mrs. Burrell—Baltimore, Md.20
Mrs. Herbert Burrill—Windsor, Vt.	2.00
Mrs. M. Byrne—Brooklyn, N. Y.	1.00
Mrs. Carey—Brooklyn, N. Y.	1.00
Miss Lynn Clare—Harrison, N. Y.	2.00
Mrs. F. N. Cosseboom—Santa Barbara, Calif.	2.00
Ann Corwin—Indianapolis, Ind.	2.00
Mrs. Frank Dankworth—Columbus, O.	1.00
Dot and Ed Renzo—Palisades Park, N. J.	1.00
Dian, Patsy, Torchy, and Mike—Kissimmee, Fla.	2.00
C. L. Ditley—Milford, Pa.	1.00
Loretta Dorhoff—Great Neck, N. Y.	2.00
Dorothy—Bridgewater, Va.	10.00
Minna L. Dowell—Ramsey, N. J.	1.00
Carl M. Drews—Orinda, Calif.50
Elizabeth Duda—Pana, Ill.	1.00
Mrs. Eliz. Earl—Newark, N. J.	1.00
Mr. & Mrs. James P. Figgins—State Center, Iowa	25.00
Mrs. Virginia Florence—Dallas, Tex.	5.00
Mrs. Viola Fowler—Hampton, N. H.	1.00
Jane France—New York, N. Y.	1.00
From People Who Admire You Greatly—Venice, Calif.	2.00
Mrs. Grohs—Hemet, Calif.	1.00
Dorothy Grover—Sharon Hill, Pa.	1.00
Mrs. M. Guenther, Mrs. M. G. Nixon, and Mrs. E. M. Shelby—Bethesda, Md.	10.00
Mrs. Lulu Haffey—Pasadena, Calif.	1.00
Edith Heller—Cranford, N. J.	2.00
Mrs. Frances Hemme—Saginaw, Mich.	1.00
Mrs. C. O. Henry—Brooklyn, N. Y.	1.00
Mrs. C. R. Hewitt—Kansas City, Kansas	2.00
Cathy, Coro Sue, Michael, Pat, and Stephen H. Hollern, Jr.—Dallas, Tex.	2.00
B. Hopko—New York, N. Y.	2.00
A. K. Illing—San Francisco, Calif.	2.00
Mr. & Mrs. J. J. Jacknain—Hillside, N. J.	5.00
John J. Janik—Whiting, Ind.	2.00
Mrs. R. C. Johnson—Buffalo, Wyo.	5.00
"Bobbie" Kaplan—St. Louis, Mo.	1.00
Mr. & Mrs. Chas. E. Kirby & Betty Ruth—Denton, Md.	2.00
Margaret N. Knight—Seattle, Wash.	27.00
Louise D. Koehler—Fort Lewis, Wash.	1.00
Mr. & Mrs. N. P. Korol & Roberta—Pittsburgh, Pa.	1.00

a Revolutionary Development!
"AUTOBOOSTER"
a fully automatic
TV-FM BOOSTER

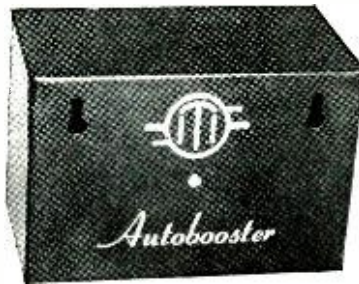

The AUTOBOOSTER turns itself on and off and is automatically tuned by the normal operation of the TV receiver. No confusing array of knobs—no unsightly mess of wires—installs in back of the receiver . . . out of sight!

Gain up to nine times, full band width for undistorted video and audio on all channels. You get all the improved performance, all the fine picture quality with none of the trouble of tuning, none of the exposed wiring usually involved in booster operation.

Regular List Price \$44.95

DEALER'S NET PRICE

\$26⁹⁵

Send \$2.00 deposit—Balance C.O.D.

The only Booster That has EVERYTHING!

- Automatic On-Off
- Automatic Tuning
- Concealed Installation
- Full Band Width (all channels)
- Amplifies FM Band
- Single or Dual Input
- Gain 19 db on LOW Channels 2-6 FM
- Gain 14 db on High Channels 7-13

GENERAL ELECTRONIC DISTRIBUTING CO.
 Dept. RC-6 98 PARK PLACE NEW YORK 7, N. Y.

FIRST BECAUSE THEY LAST

TEL-A-RAY — the antenna of unquestioned quality — eliminates "antenna shopping." Skillfully engineered to meet every TV need, the TEL-A-RAY antenna system insures outstanding fringe area performance the first time. The Reception Master antenna coupled with the new antenna mounted Pre-Amplifier brings strong, clear pictures to the weakest areas. One call . . . one installation is all that's needed. Replacement is eliminated. Reception Master antennae are built of the finest dural to resist corrosive weather damage. The element ends are sealed by the exclusive Tel-A-Roll process. TEL-A-RAY is right the first time!

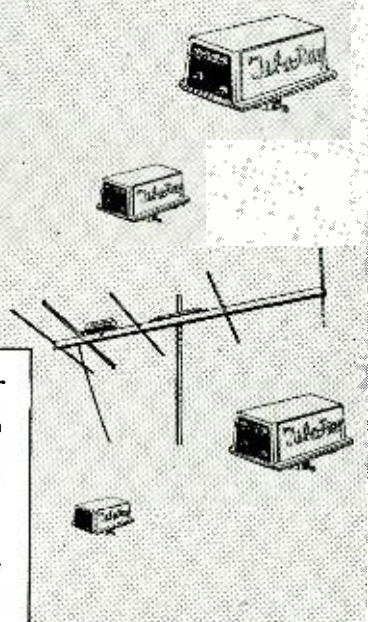

Tel-a-Ray
 ENTERPRISES INCORPORATED
 BOX 332E · HENDERSON · KENTUCKY

IMMEDIATE DELIVERY ON AUTO RADIOS

Custom built for all popular 1949-1950 and 1951 automobiles: Chevrolet, Ford, Plymouth, Dodge, Studebaker, Henry J, and Hudson.

Every radio is a powerfully built, 6 tube, super-heterodyne with RF stage and 3 gang condenser for sensitive, long distance reception. Latest miniature tubes used, with beam-power output and oversize Alnico V loudspeaker, giving plenty of volume with excellent tone. Includes Automatic Volume Control and has low battery drain.

Each model radio is Custom-Built, designed for the individual automobile and can be mounted within 4 minutes with no cables, no brackets, no holes to drill.

When ordering, indicate type automobile:

Your Price, all **\$41.97** Complete

YOUR MONEY RETURNED IN FULL—

If the New Regency Television Booster fails to improve your television enjoyment! Bring your picture out of the snow and reduce interference!

- Push-Pull Neutralized triode design assures high gain without adding snow.
- No external impedance matching devices required.
- Inductive tuning assures same high-gain wide-band operation on all channels.
- Single knob tuning control.
- Underwriters approved with 90 day RMA guarantee.

LOWEST Price—ONLY **\$19.11**

MODEL NFRD—RADIO NOISE FILTER

If it doesn't work, send it back!

We absolutely guarantee that our Model NFRD will eliminate all line noises when properly connected to radios, television sets, short wave sets, motors, electric shavers, refrigerators, vibrators, oil burners, transmitters, and all other sources of interference. This unit will carry up to 12 amperes or 1 1/4 KW of power and may be used right at the source of interference or at the radio. Small size only 3"x1 1/2"x7 1/2". Very low price only

Each **\$1.95**

A SCIENTIFICALLY DESIGNED PHONO SCRATCH FILTER

Resonated at approximately 4500 cycles effectively reducing objectionable needle scratch without altering the brilliancy of reproduction. Contains a HI-Q SERIES resonated circuit. Tested by means of an audio oscillator and an oscilloscope to give 22 db attenuation with very low signal loss.

EASY TO ATTACH

Just two wires to clip on. Compact **\$1.98**
Price

THREE TUBE PHONO AMPLIFIER

An assembled unit ready for installation using tone and volume control and six feet of rubber cord **\$2.95**

(Not including Tubes)

With Complete Set of Tubes\$3.95

PHONO OSCILLATOR

Wireless phona oscillator transmits recording for crystal pick-ups or voice from carbon mike through radio without wires. Can also be used as an intercomm by using P.M. speaker as mike. **\$2.95**
Price (excluding tubes)
With Complete Set of Tubes\$3.95

NEW HIGH FIDELITY 12" COAXIAL SPEAKER

Because of the very low price, we cannot mention the well-known manufacturer's name. Has a built-in dividing network—an ideal Woofer-Tweeter combination. Rated at 12 watts, impedance 8 ohms. Price**\$18.50**

Satisfaction guaranteed on all merchandise
All prices F.O.B. New York City
WRITE FOR FREE CATALOGUE C6

RADIO DEALERS SUPPLY CO.

154 Greenwich St. New York 6, N. Y.

Miss Linda Kuchinski—Gary, Ind.	1.00
Mrs. Lewis Laymon—Willow, Street, Pa.	1.00
Miss L. Leonardi—Newark, N. J.	2.00
Mrs. Richard Luff—Trenton, Ohio	5.00
Mrs. R. McDonough—Brooklyn, N. Y.	1.00
Mrs. Charles B. Malloy—Covington, Ky.	1.00
Mr. & Mrs. T. F. Malone—Arlington, Va.	2.00
Mrs. Victoria O. Marchi—Rumford, Me.	1.00
Mary Mattie—Scranton, Pa.	1.00
Meenan—Mineola, N. Y.	1.00
Mrs. C. E. Miller—Sterling, Colo.	1.00
Mrs. Paul M. Miller—Hamburg, Pa.	3.00
Mrs. Carolyn Mittelstadt—Bronx, N. Y.	1.00
Mrs. L. O'Conor—Los Angeles, Calif.	1.00
Mary Olles—Minneapolis, N. C.	1.00
Mrs. A. Ozerani—New York, N. Y.	1.00
George W. Percy—Westhampton Beach, N. Y.	5.00
Mrs. B. Petrov—New York, N. Y.	1.00
Ruth, Bobby & Bob Puffer—Valley Park, Mo.	1.00
E. Rabinowe—Hartsdale, N. Y.	5.00
Mary C. Roberts—East Greenwich, R. I.	2.00
Mrs. Robert Russell—Newark, N. J.	1.00
Miss Anna Russo—Bronx, N. Y.	1.00
Madeline Russo and Fellow Workers at the Crosby Dress Shop—Bronx, N. Y.	12.00
Mrs. F. Saunders—Brooklyn, N. Y.	1.00
Mrs. W. H. Say—Butler, Pa.	1.00
Katharine B. Scharb—La Mesa, Calif.	2.00
Addie Schlenck—Oxford, O.	2.00
Charles P. Schoenfelder—Brooklyn, N. Y.	1.00
Mrs. F. L. Scott—Seabrook, Tex.	5.00
Mr. & Mrs. J. S. Sheets, Jr.—Middletown, N. Y.	1.00
Joel & David Smith—New Haven, Conn.	1.00
Mrs. John B. Smith—Kansas City, Kansas	1.00
Nancy Smith—Hat Springs, So. Dak.	1.00
Mrs. Nell Snyder—Sterling, Colo.	1.00
Nancy Sturges—Philadelphia, Pa.	1.00
Mrs. L. P. Teasley—Jacksonville, Fla.	1.00
Mrs. R. Thacker—Baltimore, Md.	1.00
Jeanne Ann Van Munster—Muskegon, Mich.	1.25
Mrs. A. J. Walker—Baltimore, Md.	1.00
Josephine L. Wallace—Nutmeg, N. J.	1.00
Mrs. D. B. Wardner—San Antonio, Tex.	10.00
Mrs. Jane Willmatt—Na. Tarrytown, N. Y.	1.00
Mrs. R. Wurz—Edgely, Pa.	5.00

FAMILY CIRCLE contributions received up to April 19, 1951 \$253.95

We are also pleased to report the following collections made:

\$12.00 donated by the fellow workers at the Crosby Dress Shop, Bronx, N.Y. through the efforts of Madeline Russo.

\$5.00 contributed by the Explorer Post 12 of Warren, Pa., through Jack L. Armstrong.

RADIO-ELECTRONICS CONTRIBUTIONS

Balance as of March 19, 1951	\$7,505.26
Anonymous—California	1.00
Anonymous—El Cajon, Calif.	1.00
Anonymous—Glendale, Calif.	1.00
Anonymous—Los Angeles, Calif.	2.00
Anonymous—Oxnard, Calif.	1.00
Anonymous—Brighton, Colo.10
Anonymous—Denver, Colo.	1.00
Anonymous—Miami, Fla.	2.00
Anonymous—St. Petersburg, Fla.	1.00
Anonymous—Baltimore, Md.	2.00
Anonymous—Northampton, Mass.	1.00
Anonymous—Shrewsbury, Mass.	1.00
Anonymous—Flint, Mich.	1.00
Anonymous—Lake Odessa, Mich.	1.00
Anonymous—Great Falls, Mont.22
Anonymous—Las Vegas, Mont.	1.00
Anonymous—Newark, N. J.	25.00
Anonymous—South River, N. J.	1.00
Anonymous—Auburn, N. Y.	2.00
Anonymous—Center Moriches, N. Y.	1.00
Anonymous—Elmsford, N. Y.	1.00
Anonymous—Hempstead, N. Y.	1.00
Anonymous—Jamaica, N. Y.25
Anonymous—New York, N. Y.	1.00
Anonymous—New York, N. Y.	2.00
Anonymous—Norman, Okla.	1.00
Anonymous—Coatesville, Pa.	1.00
Anonymous—Dallastown, Pa.	2.00
Anonymous—Sellingsgrove, Pa.	2.00
Anonymous—Bellingham, Wash.50
Anonymous—Cle Elum, Wash.	1.00
Anonymous—Wheeling, W. Va.	1.00
E. B. Austin Company—Fort Worth, Tex.	10.00
Paul Ayars—Newark, Delo.	5.00
J. G. Bauer—New Orleans, La.	1.00
H. P. Becker—Brightwaters, N. Y.	1.00
Conrad H. Behler—Three Oaks, Mich.	1.00
A. Burgill—Lawrence, Mass.	1.00
Campbell—San Leandro, Calif.	9.00
H. Clay—Phoenix, Ariz.	5.00
W. E. Cole—Raleigh, N. C.	5.00
Columbia Electronic Sales—Las Angeles, Calif.	5.00
Commercial Electronics, S.A.—Mexico, D. F.	1.00
T. W. Connelly—Philadelphia, Pa.	1.00
K. Cummings—Seymour, Ind.	1.00
De Santis—Bronx, N. Y.	2.00
Daniel W. Dimick—Red Lodge, Mont.	1.00
Earl L. Dodson—Philadelphia, Pa.	1.00
Lt. H. D. Elms—Arlington, Va.	1.00

"NO BOOK
in two generations, no book since Jules Verne, has undertaken to do what Hugo Gernsback in the first decade of our century has here so outstandingly achieved."

LEE DE FOREST
Father of Radio

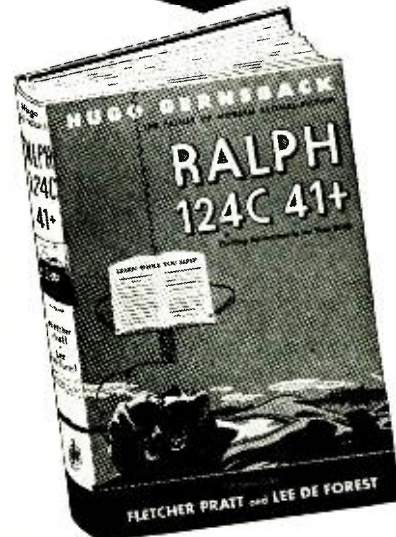

Forty years ago, Hugo Gernsback, Father of Modern Science Fiction, in this book, **RALPH 124C 41+**, predicted and described in startling detail, radar, the learn while you sleep method, television, televised operas, plastics, night baseball, blood transfusion, wire recording, micro film and a host of other scientific achievements—all undreamed of in 1911—but part of everyday life today.

All of these and scores more, not as yet realized, are found in his remarkable prophetic book. For Hugo Gernsback's prophecies are based not on fantasy but on the logical projections of established scientific facts.

RALPH 124C 41+ is the first and most remarkable true science fiction novel ever written! A whacking good adventure story that takes place in 2660 AD—but it is far more than fiction! To technically minded people, **RALPH 124C 41+** is the most complete and accurately documented catalog of scientific prophesy ever published. It was originally written in 1911 and published in book form in 1925. Now, because of its tremendous importance as a work of accurate, scientific prediction of the future, it has been reissued in a new, second edition.

Hugo Gernsback's writings were the spark that started many of today's top radio engineers and scientists on their way. Now again, this new edition of **RALPH 124C 41+** may well be the inspiration for a new generation of pioneers of science.

RALPH 124C 41+ is the kind of book you should read. Order your copy now, only \$2.50 postpaid. The supply is limited.

RADIO PUBLICATIONS
25 West Broadway New York 7, N. Y.

MAIL THIS COUPON TODAY

RADIO PUBLICATIONS
25 West Broadway, New York 7, N. Y.

Gentlemen:
Send me a copy of **RALPH 124C 41+** postpaid, at once. My remittance of \$2.50 is enclosed.

NAME.....
STREET.....
CITY..... ZONE..... STATE.....

Table listing names and amounts for Engineering Student at Syracuse University, Explorer Post 12, Thomas R. Favalaro, Roy F. Ferretti, etc.

Total received to April 19, 1951 \$7,945.78

Please keep up your efforts in behalf of Freddie, who, when he grows up will, we all hope, become a radioman once he has been equipped with his final legs and mechanical arms.

Please send your contributions from time to time—even the smallest donation will be greatly welcome.

Make all checks, money orders, etc., payable to Herschel Thomason. Please address all letters to:

Help-Freddie-Walk Fund
c/o RADIO-ELECTRONICS
25 West Broadway
New York 7, N. Y.

TELEVISION ABROAD

While the TV controversies rage at home, other countries are making progress more slowly, but perhaps also more surely. In the Western Hemisphere, Cuba now has two stations on the air in Havana, and a third is expected to begin broadcasting soon.

Brazil has one station in Sao Paulo and another in Rio de Janeiro. Argentina, Uruguay, and several other South American countries are making plans, but have done nothing definite as yet. Of the European countries, England is the most advanced in TV, having two stations now operating (one said to be the world's most powerful) and two others to be completed sometime this year.

The Russians are said to have two stations, one each in Moscow and Leningrad, and others on the way in other cities. Countries which are not yet on the air officially but which have been conducting experimental broadcasts are West Germany, the Netherlands, Sweden, and Italy.

Special—SALE—Special

Table listing Television Picture Tubes with prices: 10BP4 \$11.95, 12LP4 19.95, 14BP4 22.95, 16RP4 29.95, 16TP4 29.95, 17BF4 31.95

12" Hi-Fi Coaxial SPEAKER \$12.95
PILOT LIGHTS
100—#47 \$3.95
box of 10 .45
100—#44 and #51 \$4.74
box of 10 .59
100—#40, #41, #46 \$5.88
box of 10 .65

Radio and Television TUBES
Additional 10% discount in lots of 100 or more tubes, assorted.
Fact. guaran. Ind.
Boxed. All brands

Large table listing various radio and television tubes (e.g., 02A, 02AG, 1A5GT, 1A6, 1A7GT) and their prices.

TWIN LEAD

55 web virgin polyethylene, 300 ohm twin lead in either clear or brown
1000 ft. \$19.95 100 ft. \$2.25

Your satisfaction is guaranteed. ORDER TODAY! All ship. F.O.B. Chicago, Illinois residents add 2% sales tax. Send 10% dep. with order; bal. C.O.D. \$1.00 handling charge for orders less than \$5.00. Prices subject to change without notice.

CLEAR-VAC CO. 159 EAST CHICAGO AVE. CHICAGO 11, ILL.

PEN-OSCIL-LITE
Extremely convenient test oscillator for all radio servicing; alignment • Small as a pen • Self powered • Range from 700 cycles audio to over 600 megacycles u.f. • Output from zero to 125 V. • Low in cost • Used by Signal Corps • Write for information
GENERAL TEST EQUIPMENT
38 Argyle Ave. Buffalo 9, N. Y.

FREE TV SERVICE CONTRACT
With every 1951 Model 630 Super-Chassis ordered from 630 DISTRIBUTING CO., a FREE 30 DAY SERVICE CONTRACT is included (excluding shipping charges).
1951 MODEL 630 SUPER-CHASSIS
Order the famous 630 chassis with all 1951 improvements, designed for 16"-20" pictures. Higher brightness with new higher voltage Flashback Circuit. Higher sensitivity—the best TV set for Fringe Reception. Higher definition & clarity—with new wide-band 42 Me. video circuits. Steady pictures—with new RCA licensed Sync circuits. 12" Speaker. Lower price—because you buy direct from the distributor. All 1951 Model 630 Super-Chassis are tested for 5 hours before shipment. All tubes and parts are guaranteed for 90 days, R.T.A. licensed. Complete, ready-to-play including Free 30 Day Service Contract.
No extra taxes
less picture tube: \$149.95
SPECIAL! New 6 Mos. Guarantee—Standard Brands PICTURE TUBES—Glare-Free Black Face Type
16" Rect. or Rd. \$33.95 19" Round \$44.95
17" Rect. 20" Round 49.95
Order now! Shipments made within 24 hours!
630 DISTRIBUTING CO.
725 Sutter Ave., Brooklyn 7, N.Y., HYacinth-8870

Every RADIOMAN can use these SERVICE HINTS!
Valuable Manual Yours—FREE
Write today—no obligation.
FEILER ENGINEERING CO. Dept. 6RC1-1
8026 N. Monticello Ave., Skokie, Ill. (Suburb of Chicago)

Be Safe! Be Sure!

with a **FULL-SIZED VEE-D-X ARRESTER**



COSTS NO MORE THAN A MIDGET

2 WIRE RW-200	4 WIRE RW-204
\$125 LIST	\$150 LIST



2-WIRE RW-300 \$200 LIST

For extra heavy duty. An air gap plus resistors provide double protection.

THE LaPOINTE-PLASCOMOLD CORP.
Windsor Locks, Conn.

LEARN

Television - Radio OR Electricity
IN THE GREAT SHOPS OF **COYNE**



TRAIN QUICKLY!
OLDEST, BEST EQUIPPED SCHOOL of ITS KIND in U.S.
Young and Older Men

Come to the Great Shops of Coyne in Chicago. Get practical training in TELEVISION-RADIO or ELECTRICITY - vital in Defense Program. Prepare now for a better job or better service rating.

START NOW - PAY LATER

You can finance most of your tuition, pay for it later in easy monthly payments. Special plan for men of Draft Age. Part time employment service available. GI APPROVED

FREE BOOK Clip coupon for Big Free Illustrated Book. Indicate below, course that interests you. No salesman will call. Act NOW.

An Institution not for Profit

B. W. COOKE, Pres.
COYNE Electrical & Television-Radio School.
500 S. Paulina St., Chicago 12, Ill. Dept. A1-81H

Send FREE BOOK and full details on:
 TELEVISION-RADIO ELECTRICITY

NAME

ADDRESS

CITY STATE

JUNE MARKS WIRELESS PIONEER'S CENTENNIAL

June 12, 1951 is the 100th anniversary of the birth of that great figure of wireless, Sir Oliver Lodge.

Not of a wealthy family, he received only a grammar-school education, but he continued his education by dint of night study, first in chemistry, then in general physics, and finally as a matriculated student in the University of London, and in 1875 obtained a Bachelor of Science degree, with honors in physics. Appointed demonstrator of physics at University College, Liverpool, he immediately began to publish papers on the flow of electricity and to devise apparatus to explain conductors, dielectrics, and insulators in mechanical terms.

His most important work was in connection with tuning. As early as 1894 he demonstrated that some electrical circuits when excited would continue in electrical vibration a long time, while others would be "rapidly damped," and declared that circuits which vibrated persistently would receive only radio waves whose frequencies were near their own natural periods. In 1898 he applied for a patent on a "syntonic" or tuned receiving circuit. Although both Tesla and Marconi devised tuned circuits during the same period—possibly independently of Lodge—it was Lodge's authority and influence that established the value of tuning.

Although Lodge constructed many pieces of equipment to demonstrate radio waves and "syntony," he never became interested in wireless as a means of communication. However, his work was well known, and many scientists of the period considered him the real father of wireless. Foremost among

them was Professor Sylvanus Thompson, who in letters to the press denounced the young Marconi bitterly as a usurper attempting to steal the credit rightfully due to Lodge.

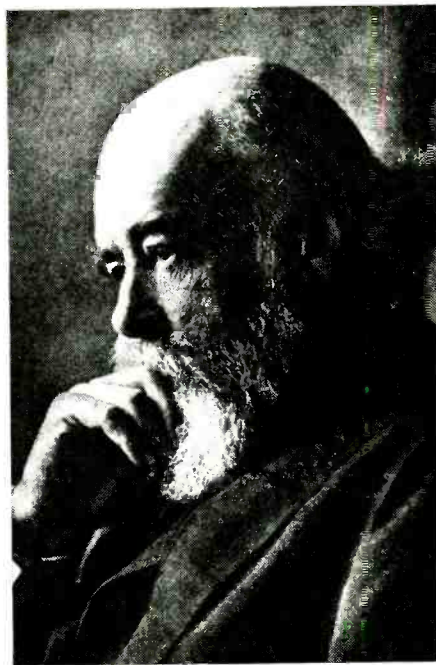

In later years Sir Oliver turned to other interests—including exploration of the occult—but maintained close connections with radio till after the beginning of broadcasting. He contributed several articles on the design of tuning inductors to the American magazine *Popular Radio* as late as the mid-20's. He died in 1940.

TELEVISION DOES EVERYTHING BUT THE COOKING

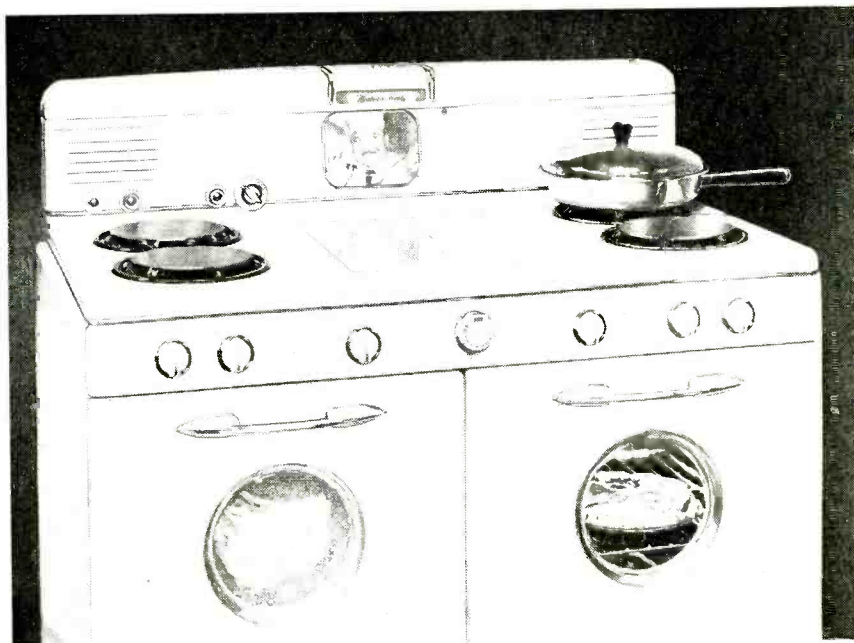

Claiming to have "scooped" the entire country, the Western-Holly Appliance Corp. has put this de luxe model gas range with built-in television on display to investigate public reaction before gearing to full production. A 7-inch screen on the back splash of the stove provides a good kitchen-size picture. The stove must be set at least 15 inches from the wall to allow room for the tube.

RADIO-ELECTRONICS for

Technical Bulletins

EACH \$1.00 Postpaid Foreign \$1.25

Electrical Design and Construction

These bulletins give you easy, accurate, dependable methods of designing and building electrical equipment. You just follow simple charts, tables and step-by-step instructions that tell how to figure correct size units to meet specific requirements.

106 Rewinding Electric Motors—Enables anyone without electrical training to locate trouble, repair and rewind a.c. or d.c. motors and generators of all kinds; how to figure wire size and wind coils.

111 Transformers—How to design and build all types and sizes of transformers including specials for Neon tubes and ultraviolet lamps. Easy methods of determining core dimensions and wire size.

152 House Wiring—Safe, approved way to wire new and old buildings. Shows many different circuits. Explains how to use latest type of materials including fittings, fixtures. Also gives estimating methods.

101 Resistance Wire—How to use Nichrome and similar wire in heating devices, rheostats and resistance coils. Figuring wire size and length; how to wind elements and test. Also supply directory.

113 Solenoids & Plunger Magnets—How to make these a.c. and d.c. magnets having movable plungers to control other equipment. How to figure dimensions, plunger stroke, wire size, etc.

112 Electromagnets—How to design and build all types and sizes for a.c. and d.c. How to figure lifting power, wire size.

148 Relays—Designing and building a.c. and d.c. relays of any size for various purposes where small currents and voltages must control heavy circuits. Includes control systems for motors and machines.

137 Meters—Designing and building ammeters, voltmeters, wattmeters, for a.c. and d.c. Includes complete information on calibrating.

127 Small Electric Light Plants—Easy-to-build, low-cost installations for cottages, camps, etc. Includes a 110-volt, seven 25-watt-lamp system; also a 6-volt system using auto generator.

151 Electric Power from Streams—How to survey streams, estimate requirements and available power, design and build dams, select and install the control system and electrical equipment.

161 Burglar Alarms & Time Switches—Dependable types for various purposes. Time switches made for alarm clocks and arranged to control lights, sprinkler systems, motors and other devices.

144 Choke Coils—How to design and build for many different purposes. How to use these instead of rheostats for voltage control, safely and with much less loss of electricity.

131 Remote Control of Electrical Devices—Circuits and applications. How to use telephone dial and Stroker switch. For experimenters and model-railroad switching purposes.

134 A.C. Electrical Experiments—Fascinating, harmless experiments for education and entertainment. Also practical uses.

TECHNIFAX, 520 N. Michigan Ave. Chicago 11, Ill.

Enclosed find \$_____ for which send the following Technical Bulletins at \$1.00 each (Foreign \$1.25) as indicated by numbers:

Name _____

Address _____

City & State _____

RE-6-51

Radio Thirty-Five Years Ago

In Gernsback Publications

HUGO GERNSBACK
Founder

Modern Electrics	1908
Electric Experimenter	1913
Radio News	1919
Science & Invention	1920
Television	1927
Radio-Craft	1929
Short-Wave Craft	1930
Television News	1931
Wireless Association of America	1908

Some of the larger libraries still have copies of **ELECTRICAL EXPERIMENTER** on file for interested readers.

JUNE, 1917 ELECTRICAL EXPERIMENTER

Talking Motion Pictures Via Wireless
The Naval Radio Operator

New Radio Transmitter for U. S.
"Mosquito" Fleet

The Japanese T. Y. K. Radiophone
System

Remarkable Radio Outfit Built by
German Spy

New Vacuum Current Gauge for Radio
The Marconi Type 106 Tuner, by Worth
MacKnight

The How and Why of Radio Apparatus
—Spark Gaps

The *Brown* Telephone Relay

SHIP OPERATORS IN DEMAND

Shipboard radio operators are needed by the Military Sea Transportation Service, Atlantic, of the Department of the Navy. Salaries range from \$3,892 to \$5,076 per year, plus subsistence and quarters. Voyages are about 90 days in duration with vessels returning to New York. Applicants must be citizens of the United States, must hold a first- or second-class FCC radio-telegraph license, and must have a code speed (receiving and transmitting) of better than 25 words per minute. To apply, obtain Form 57 from any first- or second-class post office, or from Civil Service Headquarters, and file the completed form with the Employment Branch, Industrial Relations Division, Military Sea Transportation Service, Atlantic, 58th St. and First Ave. Brooklyn, N. Y.

Electrical and electronic engineers are in demand by the Headquarters of the Air Transport Service (MATS), Washington, D. C. Salaries range from \$5,400 to \$6,400. Interested applicants may write to the Civilian Personnel Officer, Andrews AFB, Washington 25, D. C.

ARMY ADVISES INDUCTEES

Any person about to enter military service who has experience in communications, electronics, or photography is advised by the Army to bring with him all available credentials such as radio amateur licenses and union cards, to demonstrate his skill in these fields. Technically trained inductees are being assigned to Army jobs in keeping with their skills wherever possible, particularly in the electronics and communications fields where there is a critical shortage of trained personnel. Inductees should also obtain statements of experience from their employers or unions. Forms for such statements may be obtained from the Signal Corps.

BUFFALO RADIO SUPPLY

219-221 Genesee St., Dept. RE 6
Buffalo 3, N. Y.

35 MM Slide Projector & Enlarger

Most terrific photographic bargain of the 20th century.

- Takes roll film or 2x2 slides.
- Automatic slide changer furnished.
- No more waiting for enlargements to enjoy your candid shots. All you need is a flat surface to project on.
- Has 300 W 110V Bulb, but 6V, 12V, 32V, or 220V available.
- 8 precision ground, optical glass elements in optical system. (No other projector on the market has more.)
- Automatic rewind of film.
- Heat absorbing filter.
- Use as an enlarger for making your own prints of any desired size.
- Plano-Convex Meniscus Condenser.
- 5" focus Brown-Violet coated, double anastigmat F3.5 lens.
- Swivel projector head.
- Projector fits to any angle on base.
- Brand New Society for Post Education Model AAA Projector. Super Special \$50.00.
- Similar S.V.E. Projector without slide injector and coated lens \$37.50
- Small 35 mm 150 W Projector similar to above. Less slide injector and coated lens \$17.50

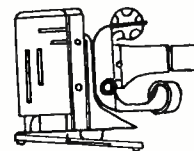

Super Midget Mike Xfmr.

Occupies less than 1/4" of space. This is the tiny, high quality transformer that is used inside bullet dynamic or velocity mikes to match the input of an amplifier tube. Makes a terrific Intercom set input xfmr to couple from the voice coil of a speaker to the amplifier input. Better quality and marked reduction in hum compared to other transformers. A beautiful input xfmr for a transceiver because of high quality & light weight. Special \$1.00 Postpaid

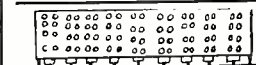

PUSH SWITCH
9 Section. Make
Break & SPDT
ca. Pressing one
releases all other-
98c

STOP IT'S MOBILE RADIO TIME AT BUFRAD 6 Volt Dynamotor

Made for use with G.E. Equipment. Worth over \$250.00. So husky we can give a standard R.M.A. guarantee on this item. Satisfaction guaranteed or money refunded if returned prepaid within 5 days.

1000 V. OUTPUT AT 350 MA.

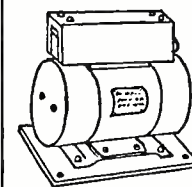

- By running with end belts removed will supply 500 MA. safely.
- Constant output voltage under varying load because of compound winding.
- Low input current (18 to 100 amps, depending on transmitter draw).
- Regular car battery will supply enough power for push-to-talk operation.
- Starting solenoid for remote operation from mike switch.
- Both sides of output voltage insulated from ground.
- Brand new in original factory boxes.
- Both input and output fused.
- Built-in interference filter.

• Special . . .
\$39.95

4-TUBE AC-DC RADIO KIT BR-24



4 tube AC-DC superhet kit No. BR-24, with high gain iron core I.F. transformer. All parts and a cabinet, but not tubes, are furnished for \$9.00. Tubes can be obtained locally or we will furnish for \$5.00 per set when the kit is ordered.

5-TUBE SUPERHET KIT BR-25

5 tube superhet kit No. BR-25 with airplane dial.

- High gain Iron Core I.F. transformers
- Efficient loop antenna
- High ratio dial drive for hairline tuning
- Good tone
- Plenty of volume
- Razor sharp selectivity
- Super sensitivity

\$10.00 complete except for tubes which can be purchased at your local radio store after the kit is wired, or purchased from us at the time the kit is ordered for \$6.50.

5-TUBE SUPERHET KIT BR-26

5 tube superhet kit BR-26. Same specs, as BR-25, but larger chassis, larger speaker, larger cabinet, and straight line dial. Your cost complete for kit \$12.00. Tubes \$6.50 per set.



Our need for thousands of tubes for kits means that kit shipment can often be expedited by relying on a local radio store for tubes instead of ordering from us, as we delay kit shipment until tubes are available to go at the same time.

Practical, Popular-priced Books on RADIO•AUDIO•SERVICING

TWO NEW \$1.00 BOOKS



No. 43—MODEL CONTROL BY RADIO. By Edward L. Safford, Jr., 112 pages. An authority in the field of radio control gives you the first complete book on the subject. For beginner and expert. Tells you what radio control is, how it works and how to construct not only component parts but a complete system as well. Illustrations explain each step.

No. 42—HIGH-FIDELITY TECHNIQUES. By James R. Langham, 112 pages. You've never seen a technical book like it! Just as he'd talk to you across the work bench, RADIO-ELECTRONICS' popular audio writer tells you how to design your own equipment and how to get top performance from it. Takes the double talk out of high-fidelity work.

THREE IMPORTANT 75¢ BOOKS

No. 41—PUBLIC-ADDRESS GUIDE. 80 pages. This handy book shows the service technician the way to extra income in big-paying PA work. Covers installation, maintenance and construction.

No. 40—THE CATHODE-RAY OSCILLOSCOPE. 112 pages. A "must" for servicing TV, FM and AM receivers and in amateur operation! Tells in simple, but technically sound language, how the 'scope works and how to use it.

No. 39—PRACTICAL DISC RECORDING. 90 pages. Tells you how to make good disc recordings. Covers every phase, theory as well as technique. A full chapter is devoted to each component.



10 POPULAR 64-PAGE BOOKS — 50¢ EACH



No. 29—HANDY KINKS AND SHORT CUTS. A treasury of time savers! Antennas, power supplies, test equipment, phonographs, amplifiers. Easy reference. Illustrated.

No. 30—UNUSUAL PATENTED CIRCUITS. A gold mine of important hook-ups. Control circuits, detectors, amplifiers, power supplies, foreign circuits.

No. 31—RADIO QUESTIONS & ANSWERS. Answers the tough ones on circuit diagrams, amplifiers, receivers, transmitters, meters and test equipment.

No. 32—ADVANCED SERVICE TECHNIQUE. A "must" for the advanced service man! Covers specialized problems of servicing not usually found in ordinary textbooks.

No. 33—AMPLIFIER BUILDER'S GUIDE. For the designer and builder of audio equipment. Covers a variety of amplifiers with power outputs from 8 to 30 watts.

No. 34—RADIO-ELECTRONIC CIRCUITS. For the experimenter—circuit diagrams of intercom systems, power supplies, voltmeters, electronic relays, receivers, etc.

No. 35—AMATEUR RADIO BUILDER'S GUIDE. For the "ham" who builds his own. Receivers, transmitters, antennas, converters, etc. Practical construction data.

No. 36—RADIO TEST INSTRUMENTS. Practical construction data on signal tracers, capacity meters, portable and bench multi-checkers, voltmeters, etc.

No. 37—ELEMENTARY RADIO SERVICING. How to get started and keep going! Planning the shop, circuit checks, signal tracing—other fundamental servicing problems.

No. 38—HOW TO BUILD RADIO RECEIVERS. Describes 18 modern sets including short wave, broadcast, vhf, portable, ac-operated, ac-dc, miniatures—types for every fan.

RADCRAFT PUBLICATIONS, INC.

SEE YOUR DISTRIBUTOR OR MAIL THIS COUPON TODAY

RADCRAFT PUBLICATIONS, INC.
25 West Broadway, New York 7, N. Y.

Enclosed is \$..... for which please send me postpaid, the books checked below.

- | | | | | | | | |
|-----------------------------|-----------------------------|-----------------------------|-----------------------------|-----------------------------|-----------------------------|-----------------------------|-----------------------------|
| <input type="checkbox"/> 29 | <input type="checkbox"/> 30 | <input type="checkbox"/> 31 | <input type="checkbox"/> 32 | <input type="checkbox"/> 33 | <input type="checkbox"/> 34 | <input type="checkbox"/> 35 | <input type="checkbox"/> 36 |
| <input type="checkbox"/> 37 | <input type="checkbox"/> 38 | <input type="checkbox"/> 39 | <input type="checkbox"/> 40 | <input type="checkbox"/> 41 | <input type="checkbox"/> 42 | <input type="checkbox"/> 43 | |

Name.....

Street.....

City..... Zone..... State.....

61

CROSLY LD MODELS

The LD models such as the 9-419-M1LD, 9-409M3LD, and others are designed especially for fringe-area reception. When these sets are operated in areas where one or more stations are exceptionally strong, the contrast and vertical sync controls may be critical and the sound output weak. These conditions may be corrected by adding variable bias to the third video i.f. stage. With this added circuit, the gain of the video i.f. stage can be adjusted for best results with either a strong or a weak signal.

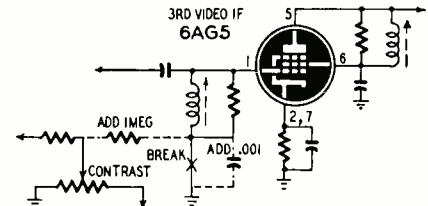

Disconnect the third i.f. grid coil from ground. Connect a .001-uf capacitor (part No. 160034) between the low side of the grid coil and ground. Connect a 1-megohm resistor (part No. 39374-61) between the low side of the third i.f. grid coil and the arm of the contrast control. The pertinent parts of the circuit are shown in the diagram. The resistor and capacitor which are added are shown in dashed lines.

If the picture brightness fluctuates with line-voltage changes, disconnect the 470,000-ohm picture-tube grid resistor from the cathode of the 6AL5 d.c. restorer and connect it to the chassis.—Crosley Service Dept.

STROMBERG-CARLSON TV SETS

Loss of horizontal sync in the TC-19, TC-125, and similar models is most often caused by an open primary on the a.g.c. pulse coil. This coil is connected

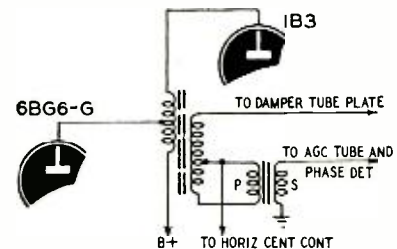

across a section of the secondary of the flyback transformer as shown in the diagram. Disconnect one side of this coil from the flyback transformer before checking continuity.—W. R. Worrell

BUICK RADIO 980798

We have received numerous complaints stating that the fuses blow when operating this and similar models. Since thorough investigations have not revealed a specific cause, we have replaced the original 15-ampere fuses with 20- or 30-ampere units.

We mention this because we know that some technicians will not violate manufacturers' recommendations. In this instance the trouble cannot be cured to the customers' satisfaction without a heavier fuse.—Adams Radio Service

7 HARD TO GET ITEMS AT BIG SAVINGS TO YOU

AMAZING BLACK LIGHT



250-watt ultra-violet light source. Makes fluorescent articles glow in the dark. Fits any lamp socket. For experimenting, entertaining, unusual lighting effects. Ship. wt. 2 lbs. ITEM NO. 87 A SAVING AT **\$2.45**

LITTLE GIANT MAGNET

Lightweight 4 oz. ALNICO permanent magnet. 1 3/4" x 1 1/2". Lifts more than 20 TIMES ITS OWN WEIGHT! Ideal for hobbyists, experimenters. Shipping weight 3/4 lbs.



ITEM NO. 159
BIG VALUE AT

\$2.45

POWERFUL ALL PURPOSE MOTOR

Sturdy shaded pole A.C. induction motor. 15 watts, 3000 rpm. 3/8" x 1 3/4". 4 mounting studs; 3/8" shaft, 3/16" diameter; 110-120 volts, 50-60 cycles A.C. only. When geared down, this unit can operate an 18" turntable with a 200 lb. dead weight. Use it for fans, displays, timers and many other practical purposes. Ship. wt. 2 lbs.



ITEM NO. 147
UNUSUAL BUY

\$2.45

WATTHOUR METER

Leading makes — completely overhauled, ready for service. 100-110 volts, 60 cycles, 2-wire A.C. 5 amp. Heavy metal case 8 1/2" x 6 1/4" x 5". Easy to install. Shipping weight 14 lbs.



ITEM NO. 33
NOW ONLY **\$4.50**

WESTERN ELECTRIC BREAST MIKE

Lightweight 1 lb. carbon microphone. Aircraft type. Breastplate mounting, adjustable 2-way swivel. Easily fastened straps. For home broadcasts, communications etc. Complete with 6 foot cord, hard rubber plug. Sherardized plate, non-rusting finish. Ship. wt. 2 lbs. ITEM NO. 152 NEW LOW PRICE **\$1.50**



TELEPHONE TRANSMITTERS

Genuine transmitters made by Kellogg, Western Electric, Stromberg Carlson. Work on two dry cells. For P.A. systems, intercoms, other practical uses. Shipping weight 1 lb.



ITEM 160
REAL VALUE **\$2.45**

250 POWER TELESCOPE LENS KIT

Make your own high powered 6 ft. telescope! Kit contains 3" diam., .75" focal length, ground and polished objective lens and necessary eye pieces. Magnifies 50x to 250x. Full instructions. Ship. wt. 1 lb. ITEM NO. 123 YOU SAVE AT **\$2.95**



HUDSON SPECIALTIES CO.
40 West Broadway, Dept. RE-6-51
New York 7, N. Y.

I am enclosing full remittance for items circled below. Shipping charges included.

OR, my deposit of \$... Ship balance C.O.D. MINIMUM C.O.D. ORDER \$5.00. C.O.D. ORDERS ACCEPTED ONLY WITH 20% DEPOSIT INCLUDE SHIPPING CHARGES.

Circle items wanted
87 159 147 33 152 160 123

Name.....
Address.....
City..... Zone..... State.....
Please Print Clearly

CROSLY 10-102E, 10-103, 10-104W

In later sets, capacitor C7 is connected between pins 1 and 7 of the 50C5 output tube instead of across the primary of the output transformer. This change improves the stability of the receiver noticeably. — *Crosley Service Department*

STRIPPED SCREW HOLES

Some sets have backs fastened to the cabinet with wood screws. The screw holes are usually stripped after the back has been removed and replaced a few times. A good remedy for stripped wood-screw holes is to slip a piece of small-diameter rosin-core solder into the hole and replace the original screw in the ordinary manner.

This will in most cases hold more securely than the original hole and will eliminate the possibility of splitting the wood with a larger screw. — *Westinghouse Service Hints*

SCOPE PREAMPLIFIER

Although it was designed for use with Sylvania 131 and 132 oscilloscopes, experimenters and service technicians will find this preamplifier a useful addition to conventional scopes of almost any make. Having a gain of approximately 30, it makes many traces viewable which do not show up well on

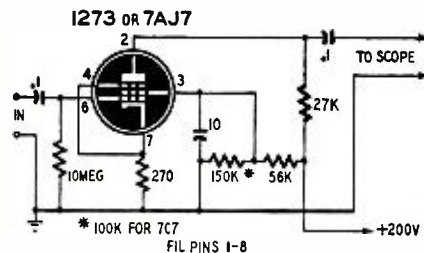

the scope alone.

The frequency response is $\pm 10\%$ from 10 cycles to 70 kc (1,000 cycles reference), down not more than 15% at 90 kc or 25% at 145 kc.

The 1273 is a nonmicrophonic pentode having physical and electrical characteristics of the 7AJ7. A 7AJ7 or 7C7 may be used. The 150,000-ohm resistor must be changed to 100,000 ohms when the 7C7 is used. — *Sylvania News*

FARNSWORTH GV-260

Complaints of insufficient width can be handled simply by connecting three .001- μ f, 600-volt capacitors in series

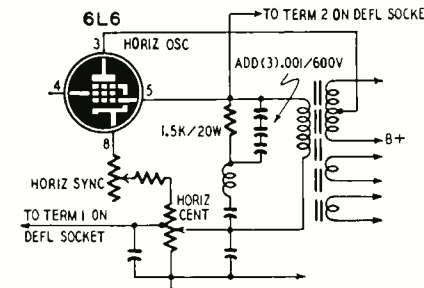

across the 1,500-ohm, 20-watt resistor connected to the grid of the 6L6 horizontal oscillator tube. This change increases the width enough to spread both sides beyond the edges of the mask. — *Frank Jusaites*

PLATT'S TOP MAN on the TOTEM POLE



with BETTER BUYS, HARD-TO-GET ITEMS, and FASTER DELIVERY

You'll save yourself a heap of money when you visit PLATT'S BIG RETAIL STORE at 489 BROOME ST., N.Y.C. So why not do it TODAY!

A REAL BUY TS-268/U CRYSTAL RECTIFIER TEST SET

Brand New—complete with set of spare parts **\$39.95**



SCR-27N COMMAND and ARC-5 EQUIPMENT

	USED	NEW
BC-453-190 to 550 KC	\$14.95
BC-454-3 to 6 MC	12.95
BC-455-6 to 9 MC	12.95
R-23-ARC 5-190-550 KC	21.95

	USED	NEW
BC-457-4 to 5.3 MC	7.95
BC-458-5.3 to 7 MC	7.95
BC-696-3 to 4 MC	18.95
T-19-ARC 5-3 to 4 MC	24.95
BC-459-7 to 9.1 MC	18.95
T-22-ARC 5-7 to 9.1 MC	12.95

	USED	NEW
BC-456 Modulator	2.25
BC-450 Control Box (3 Receiver)98
BC-451 Control Box (Transmitter)89
BC-442 Relay Unit (ANT)	1.95
Plug: PL-147, 148, 151, 152, 153, 154, 156—EACH75
Flexible Shafting with gear to fit Receivers	1.69
3 Receiver Rack	2.25
2 Transmitter Rack	1.69



FIELD TELEPHONES

Army surplus, completely reconditioned and electrically tested, using 2 flashlight cells and a pair of interconnecting wires. GUARANTEED—like new. **ONLY \$15.95**

BEACON RECEIVER BC-438

Manufactured by **Detrola**
Frequency Range—200 KC to 400 KC. IF Frequency—142.5 KC Receiver Sensitivity—5 Microvolts for 10 Milliwatts output. Output Impedance—300 ohms and 4000 ohms to be selected internally. Power Output—150 Milliwatts. Volume control — RF Gain Control. Power Supply—24.25 Volts Aeroplane Battery. Current—1.0 Amperes, 6 tubes. **BRAND NEW—ONLY \$10.95**

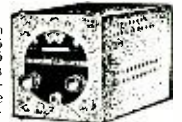

HEADSETS	
HN-33 low impedance with cord and plug, used, fine condition \$1.89
HN-23 high impedance, BRAND NEW with ear pads 3.25
HN-33 low impedance, BRAND NEW with ear pads, cord and PL54 plug 4.00
TH-37A—1200 ohms with dual plugs 2.95
HN-30 with ear plugs, low impedance, used, good condition89

BC-223 TRANSMITTER
A 30 watt Transmitter ideal for ship-to-shore or Ham Rig. Crystal or MO control on four pre-selected channels, 2000 to 5250 KC. Use of 3 plug-in coils, five tubes:
2-801 and 3-46, and TU 17-18-25 tuning units.
TRANSMITTER \$39.95
TUBES 5.95 ea.
TUNING UNITS 2.25 ea.
PE-125 VIBRATOR POWER SUPPLY FOR BC-223 \$18.95

WRITE FOR OUR FREE CIRCULAR!
MINIMUM ORDER \$2.00
Immediate Delivery—Send 25% deposit on C.O.D. order. All shipments F.O.B. N.Y.C. (N.Y.C. residents add sales tax to your remittance.)

PLATT ELECTRONICS CORP.
Dept. B, 489 Broome St., N.Y. 13, N.Y.
Phones: **WO 4-0827 and WO 4-0828**

For Highest Quality and Profits—

it's STANDARD WOOD AUDIO & TV CUSTOM CABINETS

Model RX Bass Reflex Speaker Cabinets (top): for 15" & 12" speakers. Approximately 10,000 cubic inch capacity. Wider frequency & angle distribution; higher power-handling capacity. Lumite grille cloth; no sag or stain. **Model RP Radio-Phono Cabinets (bottom):** perfect companions to Model RX. Top panel for all FM-AM tuners, middle pull-out drawer for all record changers (positions interchangeable); bottom compartment for amplifiers. **Both Models:** sturdy $\frac{3}{4}$ " stock; latest acoustic design; rich authentic furniture styling in lustrous Mahogany, Cordovan Mahogany, Walnut, Ebony, Blonde, or Unfinished.



Custom-Builders everywhere praise our full line of Custom TV Cabinets! Fit all 630 & similar chassis, all Tubes. In Mahogany, Walnut, Ebony, Blonde. See these beautiful Cabinets at your jobber TODAY. Write NOW for free latest Catalog RE.

STANDARD WOOD

PRODUCTS CORP.

43-02 38th St., L.I.C. 4, New York

CARBON RESISTORS

$\frac{1}{2}$ watt and 1 watt non insulated. 100 assorted resistors \$3.50 postpaid. Inquiries from large users solicited. We are manufacturers of resistors.

BUCK MFG. CO.

North Aurora, Ill. Phone Aurora 7993



**EVERY
RADIOMAN
Can Use These
SERVICE HINTS!**

Valuable Manual Yours—FREE!

Every page of "How to Simplify Radio Repairs" is packed with on-the-bench, practical ideas. Contains photos, charts, diagrams—no fluff—no vague theory. In plain every-day language it gives you precious suggestions—new servicing ideas. You'll use and benefit from the experience of experts. Partial list of contents: How to Service Amplifiers; How to Test for Distortion; How to Test Audio Circuits; How to Test Speakers; How to Find Faults in Oscillators; How to Test Radio Parts—and it's all yours—FREE! No obligation.



SEND COUPON OR PENNY POSTCARD FOR YOUR FREE COPY TODAY!

FEILER ENGINEERING CO., Dept. 6RC1
8026 N. Montecito
Skokie, Ill. (Suburb of Chicago)

Please RUSH my FREE copy of "How to Simplify Radio Repairs."

Name.....

Address.....

City..... Zone..... State.....

LATE PHILCO TV SETS

Starting with the 50-T1400 series, code 125 TV receivers, a blocking-type horizontal oscillator with a stabilizing section is used in all sets. When this oscillator is improperly adjusted a shrill sound of approximately 1,000 cycles may be heard and the picture will lose sync. This condition—called gunboating—is the result of double firing of the horizontal oscillator. It usually occurs when the horizontal hold control is in the extreme clockwise or counterclockwise position.



To prevent this trouble, turn the horizontal hold control *fully clockwise*, then adjust the horizontal frequency control (in the core of the transformer) to obtain five blanking bars sloping to the right. If gunboating is still apparent, rotate the *hold control* in the opposite direction then return it to the extreme clockwise position. Try resetting the frequency control on the blocking transformer.

In areas having moderately strong noise-free signals, the tendency to gunboat is reduced by adjusting the stabilizing core in the horizontal blocking transformer so the top of the rounded portion of the oscillator waveform is below the narrow pointed peak as shown at *a* in the diagram. The drawing at *b* shows the waveform which should be obtained when the oscillator circuit is adjusted for reception in weak- or noisy-signal areas. These waveforms are viewed by connecting a scope to pin No. 3 of the horizontal test jack (J600 on most diagrams).—*Philco Serviceman*

CROSLY MODEL 10-421MU

An 18,000-ohm, $\frac{1}{2}$ -watt resistor R210 has been connected in parallel with the 18,000-ohm resistor R197 to increase the horizontal drive in some sets. This may produce excessive horizontal drive when the sets are used in some areas. When this condition is experienced, remove R210.—*Crosley Service Instructions*

PHILCO 925, 926

Sets which are intermittent or dead on FM sometimes can be repaired with little or no trouble. Check the bottom lug on the oscillator stator plates. In several of these sets, the lug was found to be shorted to the frame of the capacitor by a small blob of solder. This can be cleared up by bending the lug or by removing the excess solder with a hot iron.—*Milton Margolis*

EMERSON 600 AND 639

Hum in the audio is usually caused by misalignment of the sound trap in the second video amplifier circuit. Adjust this trap to remedy the trouble.—*William Porter*

—end—

OPPORTUNITY AD-LETS

Advertisements in this section cost 35¢ a word for each insertion. Name, address and initials must be included at the above rate. Cash should accompany all classified advertisements unless placed by an accredited advertising agency. No advertisement for less than ten words accepted. Ten percent discount six issues, twenty percent for twelve issues. Objectionable or misleading advertisements not accepted. Advertisements for August, issue must reach us not later than June 21, 1951. Radio-Electronics, 25 W. Broadway, New York 7, N. Y.

SPEAKERS REPAIRED at wholesale prices. Guaranteed workmanship. Jobbers wanted. Amprite Speaker Service, 70 Vesey St., New York 7, N. Y.

RAPID RADIO REPAIR by John D. Burke—168-08 90th Avenue, Jamaica, N. Y. Postpaid \$1.25.

MAGAZINES (BACK DATED)—FOREIGN, DOMESTIC—Afr. Books, booklets, subscriptions, pin-ups, etc. Catalog 10¢ (refund). Ciccone's, 86-22 Northern Blvd., Jackson Heights, N. Y.

USED CORRESPONDENCE COURSES and Educational Books Bought, Sold, Rented, Catalog Free. Educational Exchange, Summerville, Ga.

WE REPAIR, EXCHANGE, SELL ALL TYPES OF electrical instruments, tube checkers and analyzers. Hazleton Instrument Co. (Electric Meter Laboratory), 140 Liberty Street, New York, N. Y. Telephone—Barelay 7-4239.

LANCASTER, ALLVINE & ROMMEL, 436 BOWEN Building, Washington, D.C. Registered Patent Attorneys. Practice before United States Patent Office. Validity and infringement. Investigations and Opinions. Booklet and form "Evidence of Concealment" forwarded upon request.

WANTED: AN/APR-1, other "APR", "ARR", "TS", "RT", "ART-1, ARC-3, ART-13, everything Surplus. Special tubes, Tech Manuals, Lab quality Test Equipment, etc. Describe, price in first letter. Littell, Fairbills Box 26, Dayton 9, Ohio.

TECHNICIANS !! ENGINEERS !! Interested in a top-paying electronic position? ? ? Send post card for information on HOW, WHY, WHERE, MID-CONTINENT RESEARCH BUREAU, P. O. Box 121, Wichita, Kansas.

RADIO—TELEVISION—ELECTRONICS—TUTORING \$5 per lesson—Mo. Tech., 3907 North 25th Street, St. Louis 7, Missouri.

SNIPERSCOPIES & SNOOPERSCOPIES WANTED. Any type, any condition. Needed immediately. Precise Company, 942 Kings Highway, Brooklyn 23, New York.

AMATEURS—RADIO AND ELECTRICAL RESEARCH Engineering. By Twillmann, R.R.#1, Chesterfield, Mo.

NEED ART-13; ARC-1; ART-3; DY-17; TS-12; TS-13; MN-26 J or K; BC-312; BC-312; I-100; BC-318; BC-788 A, AM, B or C; I-152A, AM, B or C; teletype; test or any other equipment. Will trade. Write: BOB SANETT (WBREX), 4668 Dockweiler, Los Angeles, California.

COUPON-OF-THE-MONTH

SAPPHIRE PHONO NEEDLES (LIST \$2.50) 2 for \$0.99
A. C. CORD & PLUG SET GPT..... 5 for .99
VOL. CONTROLS—STD. BR. .5 Meg. W. SW. 3 for .99
CONDENSERS—40-20 MFD 150V 0P..... 2 for .99
CONDENSERS—20-20 MFD 150V..... 3 for .99
LOOP ANTENNA—H. GAIN (57587)..... 3 for .99
OUTPUT TRANSFORMERS (FOR 500W)..... 2 for .99
OSC. COILS 455 KC (for 12SA7)..... 4 for .99
BY PASS COND. KIT—18 ASSD..... .99
DIAL CORD KIT—100 ft. ASSD. & 6 Springs..... .99
GRILLE CLOTH—6 Assd. 6"X6" & 10 Knobs..... .99
COMBINATION KIT—All Above Items—only..... 10.00

WITH THIS COUPON—ORDER AT ONCE

Write for Monthly Coupons and Bulletin

RADIO DISTRIBUTING CO., Pasadena 18, Cal.

WANTED

"SO" TYPE RADAR PARTS

Write or Call

World Wide Packing & Shipping Co.

350 Pearl St. Brooklyn, N. Y. MA 4-8371

You can't beat
Radio-Electronics

for complete coverage of

**RADIO, TELEVISION
and AUDIO**

RADIO-ELECTRONICS for

Here's The Antenna That Gives You
PHOTO-CLEAR TV
See The Proof . . . Where It Counts Most!
On The Screen of Your Customers' TV!
SNYDER HI-LO TV ANTENNA
Complete With Mast Sections \$6.95
Model TV 21
Two folded dipoles (high and low) with reflectors. Complete with two 3 1/2 ft. mast sections, guy rings. Ready for quick, easy installation.

MODEL AR-21. Same as TV-21 less mast sections \$4.95 and guy rings.

TV ANTENNA ACCESSORIES
STEEL EXTENSION POLES. Weather treated.
10 ft. long, 1 1/2" dia. Crimped end \$2.19
7 ft. long, 1 1/2" dia. Crimped end 1.35
15 ft. long, 1 1/2" dia. Crimped end 1.19
ANTENNA SWIVEL BASE Aluminum
Fits 1 1/2" O.D. mast section .45
GUYWIRE, 0 strand No. 20. Per 50 ft. 24 reels, 50 ft. each, zinc coated. 6.00
CHIMNEY MOUNT BRACKETS. Complete with strap 1.59
3-300 OHM STAND OFF INSULATORS
Wood screw type (42 ea.) per 100 2.95
SNAP ON TWIN LEAD INSULATORS
Fit 1 1/2" masts. Each .06
JFD LIGHTNING ARRESTORS (AT-102) 1.15
JFD LIGHTNING ARRESTOR (AT-105)
Cable ready, 1/2" baseboard .75
TIE RODS for double V type antenna. Pr. .85
TIE RODS for conical type antenna. Pr. .85
TIE RODS for inline type antenna (TR-10). Pr. .85
10" MAST COUPLINGS for 1 1/2" masts .50
8" MAST COUPLINGS for 1 1/4" masts .45
4B STACKING ASSEMBLY, 4 rods and a center tie point. For stacking 2 double XX arrays 1.95
PEAK ROOF MOUNTS for all type antenna installations. Fits wall, flat roof, any angle peaked roof. For masts 3/4" to 1 1/2" 2.69
HEAVY DUTY MAST BRACKETS WB-2 Adjustable up to 18" from wall. For masts 1" to 1 1/2" dia. 3.75

INTERFERENCE FILTERS
Drake hi-pass filters for TV receivers. Order model A for 300 ohm and model B for 72 ohm twin lead E type model \$3.57
Order from Dept. RE-6 or call Mulberry 2134
WRITE FOR FREE F.Y.I. BULLETIN

WHOLESALE RADIO PARTS CO., Inc.
311 W. Baltimore St.
BALTIMORE 1, MD.

THE RADIUM ATOMIC SPINTHARISCOPE
The SPINTHARISCOPE is one of the most amazing scientific instruments ever invented. The SPINTHARISCOPE demonstrates that radium actually destroys atoms. Look into the SPINTHARISCOPE and you see a whole firmament lit up like a brilliant night sky. You observe thousands of "stars" and untold bright flashes similar to showers of shooting stars. Every flash is the result of the destruction of one atom of radium. These fast moving helium atoms (also called Alpha rays) produce a minute flash of light when they strike a crystal of zinc sulphide contained in the SPINTHARISCOPE. The magnifying lens of the instrument makes these flashes visible to your eye. The action keeps on going for over 1800 years. Our SPINTHARISCOPE actually contains a small quantity of radium. If you want to see a most awe-inspiring sight, witness the actual destruction of thousands of worlds (atoms are miniature worlds), by simply looking through the lens of the instrument.
See RADIUM DISINTEGRATED AND DESTROYED RIGHT BEFORE YOUR EYES!
The RADIUM SPINTHARISCOPE
Item No. 190
Price, Postpaid 75c
HUDSON SPECIALTIES CO., 40 West Broadway, New York 7, N.Y.

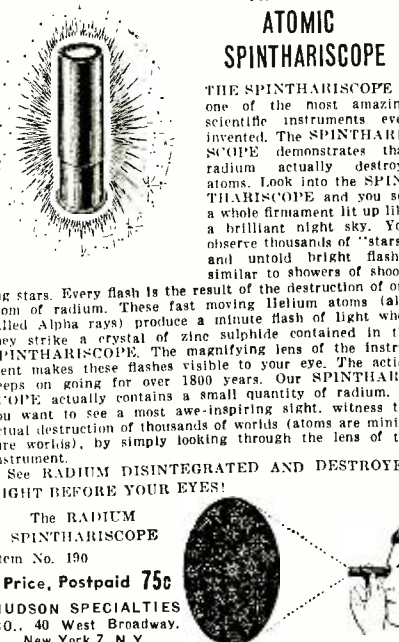

Please mention
RADIO-ELECTRONICS
when you write
to advertisers

Charles E. Krampf was elected executive vice-president of the AEROVOX CORPORATION. He succeeds Bert Conway, who resigned as executive vice-president, but will remain as a consultant and as a member of the board of directors. Mr. Krampf will continue as president of the Electrical Reactance Corporation, ceramic division of Aerovox. W. Myron Owen was re-elected president and treasurer, and J. Fraser Cocks as comptroller and clerk. The company also announced the re-election of W. Myron Owen, Herbert W. Marache, Donald E. Nichols, John Cronin, and H. Lynn Pierson as directors. Charles L. Cade joined SARKES TARZIAN, Inc. as director of distributor sales. His appointment marks the availability of the entire Tarzian line to the replacement market. Previously all the company's products except selenium rectifiers were sold only to television set manufacturers. . . . Stanley F. Patten, U. S. N. (Ret.), was named director of mobilization planning for the Government Department of ALLEN B. DU MONT LABORATORIES. He has been assistant to Dr. Du Mont since July, 1947. The company also assigned Ernest A. Marx, manager of the TV Receiver Sales Division, to additional duties as manager of the Government Department. Other appointments to the Du Mont Government Department include H. B. Graham, head of negotiations and bids; Z. Soucek, manager of the Washington office; B. V. K. French, manager of the Dayton office; Edgar H. Felix and William C. Lupfer, contract administrators, and T. G. Rogers, administrative assistant to Mr. Cramer, vice-president. . . . Frank J. Stroempel was named executive assistant to M. S. (Mike) Roth, jobber sales manager of the RADIART CORPORATION. . . . D. W. Gunn and G. V. Bureau were named equipment sales manager and government sales manager, respectively, of the Radio and TV Tube Divisions of SYLVANIA ELECTRIC PRODUCTS, INC. . . . George F. Sandore, formerly district manager of the Atlanta area, was named manager of the newly created Sales and Merchandising Section of the Technical Products Division of the RCA SERVICE Co. Carl E. Johnson, former manager of the Theater Service Section, was named manager of District Operations. Adolph Goodman, former manager of the District Sales Section, became manager of the Commercial Operations, and C. L. Swinney, former supervisor of the Atlanta district, was appointed manager of the district.



C. E. KRAMPF



S. F. PATTEN

... Stanley F. Patten, U. S. N. (Ret.), was named director of mobilization planning for the Government Department of ALLEN B. DU MONT LABORATORIES. He has been assistant to Dr. Du Mont since July, 1947. The company also assigned Ernest A. Marx, manager of the TV Receiver Sales Division, to additional duties as manager of the Government Department. Other appointments to the Du Mont Government Department include H. B. Graham, head of negotiations and bids; Z. Soucek, manager of the Washington office; B. V. K. French, manager of the Dayton office; Edgar H. Felix and William C. Lupfer, contract administrators, and T. G. Rogers, administrative assistant to Mr. Cramer, vice-president. . . . Frank J. Stroempel was named executive assistant to M. S. (Mike) Roth, jobber sales manager of the RADIART CORPORATION. . . . D. W. Gunn and G. V. Bureau were named equipment sales manager and government sales manager, respectively, of the Radio and TV Tube Divisions of SYLVANIA ELECTRIC PRODUCTS, INC. . . . George F. Sandore, formerly district manager of the Atlanta area, was named manager of the newly created Sales and Merchandising Section of the Technical Products Division of the RCA SERVICE Co. Carl E. Johnson, former manager of the Theater Service Section, was named manager of District Operations. Adolph Goodman, former manager of the District Sales Section, became manager of the Commercial Operations, and C. L. Swinney, former supervisor of the Atlanta district, was appointed manager of the district.

—end—

BARRY JUNE SPECIALS ALL MERCHANDISE FULLY GUARANTEED

● **ULTRA-COMPACT MULTIMETERS**
3 1/2" x 2" x 1 3/4"
AC & DC: 0-15V; 0-150V; 0-750V.
DC: 0-150 MA.
OHMS: 0-100,000 OHMS.
With Leads, Battery & Instructions. Brand new, boxed.
only \$8.88 postpaid

● Maguire Deluxe AM Mobile 75 meter Xmtr., New. Complete, Not Surplus, factory price \$69.00—Only a few left \$25.00

In Stock Now—Many Others Not Listed

024/024G	.90	6A86	2.15	6SN7GT	1.25
1B3GT	1.50	6A5K	2.25	6T8	1.50
1U4	1.00	6AL5	.95	6W4GT	1.00
1X2A	1.60	6AUSGT	1.70	6Y6G	1.25
2B7	.75	6AU6	1.25	12BA6	1.10
3Q4	1.00	6BA6	1.20	12BH7	1.85
3SA	.00	6BQ6GT	1.75	12SK7GT	.90
5T4	1.75	6BY5G	1.65	19T8	2.25
5U4G	1.00	6BL7GT	1.75	25L6	.90
5V4G	1.60	6J5GT	.60	50A5	1.25
5X4G	1.00	6L6	1.75	50E9	.95
6AC7	1.40	6SG7	.95	50L6	1.00
6AG5	1.60				

SELENIUM RECTIFIERS
Full-Wave Bridge
UP TO 18 VOLTS AC INPUT
UP TO 14 1/2 VOLTS DC OUTPUT
2 Amps. \$2.50
4 Amps. 4.00
8 Amps. 6.00
12 Amps. 8.00
MANY OTHERS AVAILABLE
Special rectifiers made to order • Inquiries Invited

● 304-TH New Jan Original Boxes (Eimac) \$13.95
● 450-TH JAN—Eimac @ \$29.95

Many other special purpose and transmitting types at attractive prices. Write
Phone: Rector 2-2563 Cable: Barrylect, N. Y.

BARRY ELECTRONICS CORP.
136 Liberty St., New York 6, N. Y.
\$5.00 Min. Order—25% Deposit with orders
Send Full Remittance to Save C.O.D. Charges
ALL MERCHANDISE FULLY GUARANTEED
Subject to prior sale and some price variations

STEP AHEAD . . . WITH CENTRAL TRAINING

Central Graduate R. J. Anderson, Television Engineering Supervisor, WDSU-TV, New Orleans, La. Central graduates are employed the world over—some stations are operated exclusively by Central graduates.

Be a ● Broadcast Engineer (AM-FM-TV) ● Manufacturing Technician ● Radio-Television Serviceman ● Emergency Radio Operator ● Airlines Radio Operator ● Public Address Serviceman. All essential jobs in a New, Rich field of Opportunity.

Recent survey shows Radio-TV employees earn annual income of \$4,469. Plan your professional career now, by sending for free literature.

MAIL TODAY

Free Book I want complete information on how to succeed in Television, Radio, and Electronics. This does not obligate me in any way.

NAME
ADDRESS
CITY STATE
CENTRAL RADIO & TELEVISION SCHOOLS
Dept RE-6, 1644 Wyandotte, Kansas City, Mo.

TELEVISION RECEIVER—\$1.00
Complete instructions for building your own television receiver. 16 pages—11"x17" of pictures, pictorial diagrams, clarified schematics. 13"x22" complete schematic diagram & chassis layout. Also booklet of alignment instructions, voltage & resistance tables and troubleshooting hints.—All for \$1.00. Write for free catalogue.
CERTIFIED TELEVISION LABORATORIES
Dept. C, 5507-13th Ave., Brooklyn 19, N. Y.

ON-THE-SPOT BATTERY RECORDER
WALKIE-RECORDALL 8 in. miniature BATTERY RECORDER-PLAYBACK
Continuous, permanent, accurate, indexed recording at only 5c per hr. Instantaneous, permanent playback. Picks up sound up to 60 ft. Records conferences, lectures, dictation, 2-way phone & sales talks; while walking, riding or flying. Records in closed briefcase with "hidden mike"! Write for details.
MILES REPRODUCER CO., INC.
812 BROADWAY Dept' RE6 NEW YORK 3, N. Y.

COMMUNICATIONS

MODULATION XFMRS.

- #9466 P-P 807's to P-P or Par. 807's R.F. 300 Ohm Sidetone Wdg. \$1.69
- #T104 P-P 6L6's to 832 RF, 20W. 1.49
- #5651 Screen Mod: 807 to P-P or Par. 807's: Sidetone Wdg.95

MOBILES
C.A.P. C.D.
6V. DYNAMOTOR
SUPPLY
RATINGS
Output Input
Volts 450VDC 6VDC
Amps 350MA. 45 A
OR
Volts 450VDC 6VDC
Amps 200MA. 22 A.
(Originally designed
for 14V. but Mobiles
over USA report ex-
cellent results on 6V.)
Brand New, w/Filter
Box, Starting Relay,
Mounting Plate
\$12.95
Plugs, Set of 2. \$1.00
(with Dynamotor only)



Attention CAP MEN!!!
RC 420 receiver, 3 gang TIF non-radiating receiver, designed for aircraft use, complete with tubes and C-130 tuning unit covering 200-400 kc and 2500-4700 kc. Less pwr. sup. \$3.95

CRYSTALS Low Freq.

FT-241. A holder 1/2" pin spacing, for ham and general use. Xtal controlled. Signal Generators, Q-5 RS, S.S.B. Exciters (Nov. QST) marked in army Mc harmonic frequencies—Directions for deriving fundamental frequencies enclosed. Listed below by fundamental frequency, fractions omitted.

370	419	444	485	512	391	447
372	420	445	486	513	392	448
374	422	446	487	514	393	450
375	423	448	488	515	394	451
376	424	459	490	516	395	453
377	425	461	491	518	396	454
379	425	462	492	519	397	455
380	427	468	493	520	398	456
381	429	469	494	522	400	457
383	430	470	495	523	401	463
384	431	472	496	525	402	465
385	433	473	497	526	403	498
386	434	474	502	527	404	500
387	435	475	503	529	405	501
388	436	476	504	530	406	538
412	437	477	505	531	407	540
413	438	479	506	533	408	each
414	440	480	507	534	409	each
415	441	481	508	536	411	\$1.95
416	442	483	509	537	each	
418	443	484	511	390	each	69c

Rated Concerns Send P.O. Minimum Order \$3.00
Send M.O. or CHK. Mds. Guard. Shpa. Charges
Sent C.O.D. Price F.O.B. N.Y.C. Phone Di. 9-4124

COMMUNICATIONS EQUIPMENT CO.

131 Liberty St., Dept. C-6 New York City 7, N. Y.

New! Up-to-date!

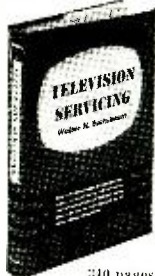

TELEVISION SERVICING

by Walter H. Buchsbaum

Get this brand new, complete handbook for sure-fire working knowledge of TV installation, maintenance and troubleshooting. Tells you step-by-step procedures for audio IF alignment, video IF alignment, aligning RF amplifiers, mixers, oscillators, etc. All possible defects classified for ready reference, thoroughly analyzed to show what is wrong and why... and what to do to correct the defect. No mathematical knowledge needed! Practical, authoritative, up-to-the-minute, the perfect handbook for set owners, trainees, and repairmen.



Symptoms of defective operation easily recognized, quickly corrected by illustrations, diagrams and how-to-do-it facts in this new book.

USE IT 10 DAYS FREE

Coupon below brings you "Television Servicing" on FREE trial for 10 days, without obligation. Mail it NOW.

PRENTICE-HALL, Inc., Dept. M-RE-651
70 Fifth Ave., New York 11, N. Y.

Send me, for 10 DAYS' FREE TRIAL, "Television Servicing." I will return it in ten days and pay nothing—or keep it and send \$1.35 down (plus postage) and \$2 monthly for 2 months.

NAME

ADDRESS

CITY STATE

SAVE! Send \$5.35 with this coupon, and we'll pay postage and packing

CONTAMINATED GRID

Dear Editor:

On page 92 of your March issue, S. W. Hou describes a very ancient trouble with multigrad output tubes. I first ran into this some 20 years ago with a few type 47 tubes, and since then have seen it in nearly every type of screen-grid output tube. The 50L6-GT is perhaps the worst offender.

This trouble is not leakage in the usual sense between grid and screen. The grid has become contaminated with some of the emitting material from the cathode, and after a thorough warmup emits electrons. Since the control grid is the most negative element in the tube, this emission will go to any of the other electrodes. As the screen is positive and very close to the control grid, most of the emission goes there and appears the same as leakage. This is only one-way leakage and gives no indication if the d.c. test voltage is polarized so that the control grid is positive and the screen negative.

The distortion noticed by Mr. Hou is due to this emission current flowing through the grid resistor in such a direction as to reduce the negative bias between grid and cathode. The higher the grid resistance, the greater this effect; thus shunting the grid resistor with 50,000 ohms reduces distortion.

Do not throw away such 50L6-GT's. Though they cannot be used again as output tubes, except perhaps in transformer-coupled amplifiers, I used them during the last war as a substitute for 35Z5-GT's and other rectifiers. The 35Z5-GT usually has pins 3 and 5 connected on the socket. One side of the a.c. line connects to pin 2 and the dial light is between pins 2 and 3. The 50L6-GT can be used here by connecting pins 2, 3, 4, and 5, either on the socket or on the pins at the base of the tube. Be sure that pin 4 on the socket does not have other connections; if it does, remove them. If jumpers are put on the tube base, a 35Z5-GT can be put back in the socket when available without any wiring changes.

I cannot bring this letter to a close without telling you that for a great many years I have been a reader of your magazines and in that time have gotten a great deal of pleasure and good from them.

W. L. JOHNSTON

Arlington, Texas

5-TUBE POCKET SUPER

It was necessary to withdraw the article "5-Tube Pocket Super" from the May issue at the last moment, due to a problem which had to be solved by correspondence with the author. The story is again being readied for an early issue, and will probably appear in July or August. Our sincere apologies to those miniature fans whose hopes were aroused by the announcement on our May cover.

—end—

AUTOMATIC M-90 AUTO RADIO



- Six Tube Superheterodyne • Three Gang Condenser • Powerful, Long-Distance Reception • Fits All Cars, Easy Installation
 - Mounting Brackets Included
 - 6 Tube model M90.....\$33.87
*Above price includes Federal Excise Tax.
- Approx. shipping weight (11) eleven pounds.

MAIL US YOUR ORDERS

All orders filled within 24 hours.
Standard Brand tubes 50% off list

Bill Sutton's Wholesale Electronics
Fifth at Commerce Fort Worth, Texas



DISTRIBUTORS OF Automatic Custom AUTO RADIOS

Net... \$45.02

1949-1950-1951 Ford, Chevrolet, Plymouth, Dodge, Hudson; 1950-1951 Studebaker; 1951 Henry J.

EVERY SET A CUSTOM 6 TUBE, 3 GANG HIGH-POWERED SUPERHETERODYNE
Mail Orders Filled Promptly. Specify Car and Year. Postage Prepaid on Cash Orders; COD's accepted in U.S.A.
PROGRESSIVE ELECTRONICS CO.
497 Union Ave., Dept. RE 48, Brooklyn 11, N.Y.
(See advertising index for other advertisement of Progressive Electronics Co.)

ATTENTION

Radio Service Dealers, Hams, Engineers and Experimentors. Quality Merchandise at

REGULAR DISCOUNTS

We are an old established firm looking for new accounts.

Only well known standard brands (no surplus), such as G.E. and Hytron tubes at regular discounts. Sprague condensers, IRC and Centralab resistors and volume controls, Burgess and Eveready batteries. Quam and Cletron speakers, EICO, Precision and Simpson test equipment and instruments, Chicago and Thermador transformers, etc.

We also have a complete stock of TV replacement parts, masks, etc.

ALL ORDERS FILLED SAME DAY RECEIVED
NO ORDER TOO LARGE OR TOO SMALL.
WHOLESALE ONLY.

We want satisfied customers. Get acquainted with us now. Send us a list of your requirements. Write for our regular bulletins.

COAST ELECTRONIC SUPPLY CO.
527 W. Main Street, Alhambra, California
Phone: ATLantic 9-4361.

WANTED

- PE-237 POWER SUPPLY
 - GN-58 GENERATOR
 - 1306 TRANSMITTER RECEIVER
- BEST PRICES—NO QUANTITY TOO BIG, NONE TOO SMALL.

WRITE TODAY
GIVING DETAILS TO —

Box P-51-6, c/o Radio-Electronics, 25 W. Broadway, N.Y.C.

F-M SIMPLIFIED (Second Edition), by Milton S. Kiver. Published by D. Van Nostrand Co., New York, N. Y. 5 3/4 x 8 1/2 inches, 458 pages. Price \$6.50.

This latest edition is a complete revision of a popular work which has been widely used as an elementary textbook on FM theory and practice. It has been rewritten, 111 additional pages of text and illustrations have been added, and the material has been rearranged so the various discussions fall into a more logical sequence.

Like the first edition, this book serves to bridge the gap between AM and FM techniques. It explains fully and in simple language the theory of FM propagation and FM receiver and transmitter circuits. Several chapters are devoted to detailed descriptions of circuits in commercial FM receivers and methods of servicing them.—RFS

TELEVISION AND FM ANTENNA GUIDE, by Edward M. Noll and Matthew Mandl. Published by The Macmillan Co., 60 Fifth Avenue, New York, N. Y. 6 1/2 x 9 1/2 inches, 311 pages. Price \$5.50.

The performance of many TV and FM sets—particularly in weak-signal and fringe areas—depends directly on the type of antenna and its installation and orientation. If the installation crew lacks a thorough understanding of v.h.f. antenna theory, the performance of the set is likely to be unsatisfactory.

Messrs. Noll and Mandl, authors of a series of articles on TV antennas in RADIO-ELECTRONICS, have prepared this book to enable the TV and FM installation man to get the most out of any set in a given location.

After devoting the opening chapter to discussions of radio propagation, the authors get down to cases and devote the balance of the book to practical design data, specifications, and characteristics of basic antenna types. Drawings and photographs are used to illustrate the antenna under discussion. In round-

ing out the book into a guide or handbook on antennas for TV and FM reception, the authors cover transmission lines, interference elimination, commercial boosters, and general installation hints.—RFS

RADIO AND TELEVISION RECEIVER CIRCUITRY AND OPERATION, by Alfred A. Ghirardi and J. Richard Johnson. Published by Rinehart Books, Inc., New York, N. Y. 6 1/2 x 9 inches, 669 pages. Price \$6.00.

The modern service technician must be thoroughly familiar with the basic circuits of both aural and visual receivers if he wants to stay in business long. This book is intended to provide just that familiarity. It is a text for technical schools or for the practicing technician who needs a home refresher course.

It differs from most textbooks by being clear and concise. What is perhaps more important, it covers those many little practical details (such as how to check for filament continuity in a.c.-d.c. sets and how push-button tuning mechanisms operate) so often omitted in textbooks.

All types of home receiving equipment are covered. Each chapter concludes with a summary of the high points, a set of questions, and problems.

SURVEY OF MODERN ELECTRONICS, by Paul G. Andres. Published by John Wiley & Sons, Inc., New York, N. Y. 5 1/2 x 8 1/2 inches, 522 pages. Price \$5.75.

A one-volume treatment of the vast field of modern electronics naturally can cover only the highlights. But that is exactly what Professor Andres intends with this book, which was written for a short course in electronics to show beginning engineering students what they are getting into. It demonstrates the vital importance of electronics to nearly all branches of science and engineering.

Leotone

1N21 Crystal Diodes, Special . . . 69c 10 \$6.50
 2-E-1 20 W.P. Motor #28179 . . . 1.10
 7-A-1 125 10M, shunt wound, O.D. 4 3/4" x 5 1/2" . . . 2.95
 Double 3 1/2" shaft . . . 2.95

TV Screen Filters, Eilat # 2.95
 Improve Contrast, Lt. Blue or
 Smoke, 10" — 98c 12" — \$1.39
 T-301, Tri-Fluoride, 10" brand
 new . . . 49c 6 2.49

CD-508 Ext. Cord & Switch for T-301V . . . 49c 6 2.49
 T-440 Magn. Mike (SCR-522) new 7 1/2" . . . 39c
 High Fidelity Crystal Mike, Hi-imped. Rubber
 shock-mtd. 1 1/4" x 3/4" . . . 1.29
 Aluminum Housing for crystal Mike15
 Alnico Magnet Kit, powerful Bar. Block, "U" . . . 1.98
 Roll King, Kit of 10 assorted
 Write for New "Alnico Magnet"
 Hearing Aid Amplifier (2 tube)
 Make a Real Vest Pocket Radio addi-
 tional simple tuner, 1 1/2" x 2 1/2"
 Schematic 2 or 3 Tube Set, less
 tubes, case \$2.49
 Hearing Aid Tubes for above Ampli-
 fier, 20 of 2 2.49
 Hearing Aid Bone Conduction Re-
 ceiver, Excel. Contact Mike, Min.
 Spkr. 1/2" x 3/4" x 1/2" 2.49
 Speaker Parts Specials!!! cones are less voice coil.
 Kits of 12 Ass'd. Cones 1.25
 7" O.D. 1.45
 4" to 12" Assortment, incl. free-otg. 12 ass'd. . . 51.98
 Speaker Repair Kit, liberal assortment of: Spil-
 ders, V.C. Motors, Rings, Chassis, S.P. Cells,
 Shims, Cement and Instructions, All for Only . . 2.49
 Both \$1.98 Cone & Repair Kits for Only . . . 3.95
 Speaker Shim Kit, 4 thicknesses, 9" 8c
 Radio Hardware Treasure, Full Pound Can of
 Nuts, Screws, Washers, Lugs, etc. 69c 3/1.98
 Ferr. Tech. Manual, 212 pgs. 1.39
 R-89 ARN-5 Glide Path Receiver Diagram 25
 BC-603 10 Channel Push-Button Tuner, new . . . 4.95
 Television "Glow" in Dark, 100 ft. x 2 1/2" . . . 49c
 RG-13 U-CO-AX CABLE, .74 ohm, 20 ft. lgh. . . 1.39
 Astatic Curved P.U. Arm, 9", less cartridge . . . 69c
 Maguire Changer P.M. (Astatic), 9", less cartridge . 8c

 "Motor Construction Kit" Hobbyists, Students, . .
 Experimenters!!! Build a compact Fract. H.P. . .
 1750 RPM motor (4 1/2 V. D.C.) Overall: 1 1/2" x 2 1/4" . .
 2 1/2" Complete, simple ass'y, instruct.
 batt. ONLY \$1.49

 AC-DC Blower (Model) 24 blade 3 1/2" impeller, less
 240V RPM 27V, 1 1/2" x 3 1/2" \$3.95
 4 Tube Amplifier Foundation (tube) Loaded
 with Parts! Crackle cabinet, slide-in chassis!
 10" x 1 1/2" x 3 1/2" Less tubes 1.49
 Selenium Rectifiers, F.W. Bridge, 18V, AC, 6A, 129
 1 1/2" Wave, 54V, AC, 5 amp, 79c 4 2.99
 Coil Set C-14 (W.E.) incl. 41055C Nial 1.49
 4 Wire Flat Rotor Cable (1/2" x 1/8") 16
 strand, gray rubber 6c ft. 100 ft. 4.95
 2AC Fuse Blocks, case 100's 12c 10 1.00
 Masonite Panels 7" x 16 1/2" x 1 1/2" 39c 3 1.00
 3:1 Audio Transformer (Cardwell) 2 1/2" x 1 5/8" x 1 1/2" . 89c
 Telegraph Key & GV. Buzzer, Walnut bakelite base 1.49
 AC-DC Neon Test Lite, 110-220V 15c 8 1.00
 Antenna Leads (AC-DC), 4' x 8' or 3' x 10' 39c 3 1.00
 Intercom Cabinet for 4 spkr. & 2 amp. 10V 10" fin-
 ish wood, Overall: 9 1/2" x 4 1/2" x 1 1/2" 98c 6 5.00
 Tube Carbons, plain white (prices per 100).
 Min. 1 1/4" x 3 1/2" 1.20 10 12.00
 Min. 1 1/2" x 4 1/2" 1.65 10 15.00
 Min. 1 3/4" x 4 1/2" 1.98 10 17.00
 Push-Back Wire, #20, red, vel. blue, black, 100 ft. . . 89c
 *FACTORY SPEAKER REPAIRS SINCE 1927
 Min. Order \$3.00 20% deposit on all COD's
 Please add sufficient postage—excess refunded
 Full remittance with foreign orders.

LEOTONE RADIO CO.
 67 Dey Street,
 New York 7, N. Y.

500 FORMULAS TO SUCCESS

MANY million dollar firms started with a single formula, for which they paid a big price. Here you have 500—no less—tried and tested formulas, recipes and processes for making things . . . all at the ridiculously low price of 25c. Here is your opportunity to start a business with but a few dollars' outlay and with undreamed of profits in prospect. You can also use these formulas in your own home to cut household expenses to the bone. Or you can put them to use in your workshop to cut costs as much as 100%. Quit paying out many dollars in profits to manufacturers, wholesalers, and dealers, when you can make the same thing yourself for a few cents. It's so easy when you follow our simple instructions.



66 PAGES, 47,000 WORDS IN TEXT
 Send for "500 FORMULAS AND RECIPES" today. En-
 close 25c, that's all! You won't be asked for another
 cent now or later. Sold on a money-back guarantee.

NATIONAL PLANS COMPANY
 1966R Broadway New York 23, N. Y.

SHOOT TV TROUBLE FAST!

With H. G. CISIN'S RAPID
 "TV TROUBLE SHOOTING METHOD"
 EARN more money! Locate television troubles by
 this quick, entirely new method. Rapid checks enable
 you to locate all faults in record breaking time re-
 gardless of make or model! 100 Picture, Raster,
 Sound trouble symptoms. Over 100 Rapid checks in-
 cluding over-all alignment checks, 26 illustrations;
 simplified step-by-step directions!

INCREASE your earning power with the most valu-
 able aid to TV servicing ever written! SEND YOUR
 NAME AND ADDRESS TODAY \$100
 WITH ONLY
 RUSH COUPON NOW!

H. G. CISIN, CONSULTING ENGINEER, Dept. E-4
 200 Clinton Street, Brooklyn 2, N. Y.

Name _____
 Address _____
 City _____ Zone _____ State _____



Prepare Now!

RADIO ENGINEERING

B. S. DEGREE IN 27 MONTHS

Complete Radio Engineering course incl. Telev., U.H.F. and F.M. BS Degree Courses also in Mech., Civil, Elect., Chem. and Aero Eng.; Bus. Adm., Acct. Extensive campus, modern buildings, well equipped labs. Low cost. Prep. courses. Personalized instruction. Heavy demand for graduates. Placement service. Founded in 1884. Prepare now for the civil and military opportunities ahead. **VETERANS:** You may still obtain training and a college degree at Tri-State College under present G.I. Bill. Last opportunity for new students to enroll is Summer Quarter, June 11, 1951. Hundreds of Tri-State veteran graduates are holding responsible positions with unlimited opportunities for future advancement. *Enter June, Sept., Jan., March. Write for Catalog.*

TRI-STATE COLLEGE
2461 COLLEGE AVE. ANGOLA, INDIANA

PRESENTING...

A NEW department of the DON MARTIN SCHOOL OF RADIO AND TELEVISION ARTS AND SCIENCES . . . for instruction and training in—**TELEVISION**—incorporating:

Production: Writing, Directing, Producing, Acting, Staging, Lighting.

Engineering: Transmission, Receiving, Camera and Studio, Operation, Theory of Video, Pickup and Reproduction.

Approved for veterans.

THE DON MARTIN SCHOOL OF RADIO AND TELEVISION ARTS AND SCIENCES
1655 No. Cherokee, Hollywood 28, Calif. H.U. 23281.

TELEVISION

PREPARE FOR A GOOD JOB!

COMMERCIAL OPERATOR (CODE)
RADIO SERVICEMAN

TELEVISION SERVICING
BROADCAST ENGINEER

Approved for Veterans
SEND FOR FREE LITERATURE

BALTIMORE TECHNICAL INSTITUTE
1125 Eutaw Place, Dept. C, Baltimore 17, Md.

VF RADIO ENGINEERING
FM—Television—Broadcast

Police Radio, Marine Radio, Radio Servicing, Aviation Radio and Ultra High mobile applications. Thorough training in all branches of Radio and Electronics. Modern laboratories and equipment. Old established school. Ample housing facilities. 7 acre campus. Small classes, enrollments limited. Our graduates are in demand. Write for catalog.

Approved for Veterans

VALPARAISO TECHNICAL INSTITUTE
Dept. C VALPARAISO, INDIANA

CODE SENDING RECEIVING SPEED

Be a "key" man. Learn how to send and receive messages in code by telegraph and radio. Commerce needs thousands of men for jobs. Good pay, adventure, interesting work. Learn at home quickly through famous Candler System. Qualify for Amateur or Commercial License. Write for FREE BOOK.

CANDLER SYSTEM CO.
Dept. 3-G, Box 928, Denver 1, Colo., U.S.A.

AUDIO (SOUND) ENGINEERING HOME STUDY TRAINING

Practical, easy-to-understand lessons, written by competent Audio Engineers and Educators, prepare you for a better job and a good future in the Television, Radio, Motion Picture, and Recording Industries.

Write today for details—Learn while you earn!!

HOLLYWOOD TECHNICAL INSTITUTE
Div. RE
4925 Santa Monica Blvd. Hollywood 27, California

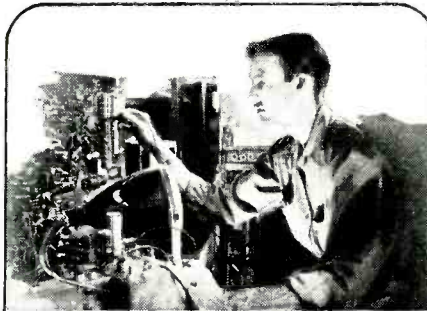

ENTER RADIO TELEVISION

thru this Proven Plan

As a young man with a career to build, you may *today* be interested primarily in training for Radio — and perhaps for TV. But — *who knows* . . . you may some day have both the desire and opportunity to climb further and become an Electrical Engineer! Here, then, is a world-renowned educational *plan* that permits you to use your Radio training as a *major stepping-stone* to an even greater career.

IN 12 MONTHS BECOME A RADIO TECHNICIAN

Train here for radio shop operator or serviceman, mobile receivers and all types of transmitters, and for supervision of service personnel. You may then advance immediately, or at any future date, into courses described below.

IN 6 ADDITIONAL MONTHS you become a Radio-Television Technician

An additional 6-months course gives you intensive TV Technician's training — under the *personal guidance* so necessary in this expanding field.

ALSO...YOUR RADIO COURSE IS FULL CREDIT TOWARD THE B.S. DEGREE IN ELECTRICAL ENGINEERING

The Radio course, while complete in itself, is *one-third* of the college program (major in Electronics). Further — you are guided scientifically toward specialization beyond basic engineering training.



B.S. DEGREE IN 36 MOS.
Military, practical or prior academic training evaluated for advanced credit. Terms open July, October, January, April.

MILWAUKEE SCHOOL of ENGINEERING

Technical Institute • College of Electrical Engineering

FREE—Write for "Occupational Guidance Manual" and 1951 Catalog.

MILWAUKEE SCHOOL OF ENGINEERING
Dept. RE-651, 1020 N. Broadway
Milwaukee, Wis.

Without obligation, mail Occupational Guidance Manual on:

- Radio-TV Electrical Power Welding
- Heating, Refrigeration, Air Conditioning
- Also send 1951 Catalog for Electrical Engineering, B.S. degree in Electric Power Electronics

Name..... Age.....

Address.....

City.....Zone...State.....

Check if World War II Veteran

RADIO COURSES

Preparatory Mathematics, Service, Broadcast, Television, Marine Operating, Aeronautical, Frequency Modulation, Radar.

Classes now forming for the Summer term beginning June 1st
Entrance exam May 21st

Veterans. Literature.

COMMERCIAL RADIO INSTITUTE
(Founded 1920)
38 West Biddle Street, Baltimore 1, Md.

LEARN DAY and EVENING CLASSES

TELEVISION

ELECTRONICS-RADIO
Modern Laboratory Instruction in

- SERVICING
- BROADCAST OPERATING
- ELECTRONIC and TV ENGINEERING

G.I. APPROVED

WRITE FOR ILLUSTRATED CATALOG

ELECTRONICS INSTITUTE, Inc.
21 HENRY, DETROIT 1, MICH.

BECOME A RADIO AMATEUR

COMPLETE HOME-STUDY COURSE FOR PASSING FCC AMATEUR RADIO EXAMINATIONS.

LOW COST PERSONAL COACHING

Write for details

FEDERAL ELECTRONICS INSTITUTE
45 East Putnam Ave. (Dept. F) Greenwich, Conn.

RADIO ENGINEERING 27 MONTHS DEGREE

Intensive, specialized course including strong basis in mathematics and electrical engineering, advanced radio theory and design, television. Modern lab. Low tuition. Self help opportunities. Also 27-month courses in Aeronautical, Chemical, Civil, Electrical and Mechanical Engineering. Approved for G.I.s. Enter June, Sept., Dec., March. Catalogue.

INDIANA TECHNICAL COLLEGE
158 E. Washington Blvd., Fort Wayne 2, Indiana

AUDIO ENGINEERING SCHOOL

Practical engineering training in Audio fundamentals, Disc, Film, Magnetic Recording, and Audio frequency measurements. Studio training simulates Broadcast, Motion Picture, Television, and Commercial Recording work. Approved for Veterans

HOLLYWOOD SOUND INSTITUTE, Inc.
1040 E North Kenmore, Hollywood 27, Calif.
Specify if Veteran or Non-Veteran

RCA RADIO and TELEVISION

Thorough Training For Men and Women in All Technical Phases

APPROVED FOR VETERANS

DAY-EVENINGS WEEKLY RATES
FREE PLACEMENT SERVICE FOR GRADUATES
For Free Catalog Write Dept. RC-51

RCA INSTITUTES, Inc.
A Service of Radio Corporation of America
350 WEST 4TH STREET NEW YORK 14, N. Y.

RADIO COURSES

- RADIO OPERATING • CODE
- RADIO SERVICING • ELECTRONICS
- F.M. TELEVISION

Preparation for Civilian, Maritime, Army and Navy license requirements.
Write for Catalog TE

Y.M.C.A. TRADE & TECH. SCHOOL
229 W. 66 St., N. Y. 23
ENclon 2-8117

SERVICING RADIO AND TELEVISION WITH A VACUUM TUBE VOLTMETER, Published by Sylvania Electric Products Inc., 1740 Broadway, New York 19, N. Y. 8 1/2 x 11 inches, 48 pages. Price \$1.00.

The text of this booklet was prepared by Rufus P. Turner, a writer well known to readers of this magazine. He discusses the various types of v.t.v.m.'s., and—in a chapter each—their use in radio receiver tests, audio amplifier measurements, television receiver tests, and miscellaneous applications. The booklet is attractively printed and well illustrated.

UNDERSTANDING RADIO (Second Edition), by Herbert M. Watson, Herbert L. Welch, and George S. Eby. Published by McGraw-Hill Book Co., New York, N. Y. 6 1/2 x 9 1/4 inches, 716 pages. Price \$5.50.

Understanding Radio is a simple but thorough home-study type text and workbook for those with little or no knowledge of radio. Fundamentals of radio receiver and transmitter theory are introduced one-by-one in a logical sequence. New technical terms and theories are introduced gradually so there is no sharp transition from one thought to another. Over 500 drawings, diagrams, and photographs are used to illustrate the text.

A number of simple radio and electrical experiments which enable the

reader to learn by doing are described. The experimental setups which can be used to study vacuum-tube circuits and to construct amplifiers, receivers and transmitters are described in detail. The more advanced experiments are performed by combining circuits constructed in earlier lessons.

MAKING MONEY IN TELEVISION SERVICING, by Eugene Ecklund. Published by Howard W. Sams & Co., 2201 East 46th St., Indianapolis, Indiana. 5 1/2 x 8 1/2 inches, 136 pages. Price \$1.25.

The author, himself successful in the television service business, points out that the problems of the new industry had to be answered largely by guesswork, but that a previous grounding in business methods helped in guessing right. Having learned many of the answers through three years of actual experience, he now shares them with the rest of the television servicing fraternity.

The book begins with planning and establishing the new business, and while covering such standard subjects as location, overhead, collections, and advertising, brings in a few subjects not always covered in such a book. Thus, expansion, work control, and the problems of busy and slack seasons are discussed in the light of the special features of the television service business. Obviously, actual installation and service problems

do not belong in such a book, but forms for installation and servicing and hints on reporting trouble are included.

DUNLAP'S RADIO AND TELEVISION ALMANAC, by Orrin E. Dunlap, Jr. Published by Harper & Brothers, 49 East 53rd St., New York 16, N. Y. 5 3/4 x 8 1/2 inches, 211 pages. Price \$4.00.

A complete chronology of radio from 640 B.C. to November, 1950 A.D., this book is a handy reference for student, writer, or any person who may have to know who did what, and when, in the radio field. Divided into sections, or eras, with a short introduction to each, it becomes an interesting work for the general radio reader as well.

The chronology is supplemented by a 32-page insert of photographs of famous men and events in the history of communications, and there is a complete index by subjects.

—end—

COMPUTING MACHINERY COURSES
Guided study for the beginner or advanced student with 100% cooperation from the instructor when needed.
Write us for complete information on our courses.
EDMUND C. BERKELEY AND ASSOCIATES
MAKERS OF SIMON
World's Smallest Electric Brain
36 West 11 Street, New York 11, N. Y.

GREYLOCK TUBES
All Greylock tubes carry the standard RTMA guarantee. Tube orders shipped F.O.B. New York. On all C.O.D. orders please enclose a 10% deposit. All prices are subject to change without notice.
June Special: 5% off prices shown below on 1 to 50 tubes—10% off on prices shown below on 51 to 100 tubes—5% plus 10% off on prices shown below over 100 tubes.

Type	Each	Type	Each	Type	Each	Type	Each	Type	Each
01A	\$.69	5V4G	\$1.39	6F8G	\$.99	12AT6	\$1.79	35Y4	\$.89
0A4	1.49	5W4M	.79	6E6G	.49	12AT7	1.69	35Z3	.89
0Y4	1.49	5W4GT	.79	6E7	.59	12AU6	1.19	35Z4G	.89
0Z4M	.89	5X4G	.89	6H6GT	.89	12AU7	1.49	35Z5GT	.89
1A3	.69	5Y3GT	.69	6H6M	.89	12AX7	1.69	36	.69
1A4P	.39	5Y4G	.79	6J5GT	.69	12AX7	1.39	37	.69
1A5GT	.79	5Z3	.89	6J6	1.09	12BA6	.99	38	.69
1A5	.39	5Z4	1.09	6J7GT	.89	12BA7	.99	39/44	.99
1A7GT	1.09	6AB4	1.09	6J8G	1.09	12BD6	.99	41	.99
1B3 8016	1.49	6AC5GT	.99	6K5GT	.79	12BE6	.99	42	.99
1B4	.49	6AB5 6N5	.99	6K6GT	.79	12BF6	.69	43	.99
1B5 253	.49	6AC7	1.29	6K7GT	.69	12BH7	1.39	45	.99
1B7	.59	6AE3	.99	6K8GT	.79	12CH8	.89	45/23	.99
1C5GT	.99	6AE6	.79	6L6G	.49	12F5GT	.89	45/25GT	.89
1C6	.39	6AF5	.89	6L6GA	1.09	12J5GT	.69	47	.79
1C7G	.49	6AG5	1.59	6L6M	1.99	12J7GT	.89	49	.79
1D5GP	.49	6AH5	1.49	6N6	1.89	12K8GT	.79	50A5	1.19
1D7	.49	6AH6	1.49	6N7GT	1.19	12Q7GT	.79	50B5	1.19
1D8	.49	6AR5	1.49	6P5GT	.79	12SA7GT	.79	50C5	1.09
1E5	.49	6AK5	1.39	6D7GT	.79	50I6GT	1.09	7C3	.79
1E7	.49	6AK6	1.19	6D7H	.79	50Y6GT	1.09	7C6	1.09
1F4	.39	6AL5	1.19	6D7H	.79	12SC7	.89	52	.99
1F9	.49	6AQ5	1.19	6R7GT	.69	12SF3GT	.59	53	.79
1F7	.49	6AR5	.89	6S5	.99	12SF7M	.69	55	.89
1G4GT	.69	6AR6	.99	6S7G	.99	12SG7M	1.19	58	.69
						12SH7M	.99	57	.69

1G5 .49 HAS5 1.19 6S8GT 1.29 12SJ7GT .89 58 .79 7F7 .89
 1G6 .69 HAT6 .79 6SA7GT .99 12SK7GT .99 70A7 1.29 7F8 1.59
 1G6G .69 HAT6 .79 6S6GT 1.19 12SL7GT .99 70L7GT 1.09 7E2 .99
 1HG1T .99 HAU5 1.19 6SD7GT .79 12SN7GT .99 71A .99 7H7 .99
 1H6 .49 HAV5 1.49 6SF5GT .69 1.09 75 .79 7J7 .99
 1H6G .49 HAV6 .79 6SF7M .89 12SQ7GT .89 76 .79 7K7 .89
 1I4 .89 HAZ .99 6SG7M 1.19 12SR7GT .79 77 .79 7L7 .99
 1I5GT .99 HA4 1.29 6SH7GT 1.19 12SB7GT .69 78 .99 7M7 1.19
 1I5GT .89 HA5 .99 6SI7GT .89 1223 .49 79 .79 7Q7 .79
 1Q5GT .89 HA6 .99 6SK7GT .89 35 .99 80 7R7 .79
 1R5 .99 HA7 1.29 6SL7GT 1.19 1R 89 81 .99 7S7 .99
 1S4 .99 H8GT 1.29 6SN7GT 1.29 19 49 82 .99 7U7 1.39
 1S5 .89 H8M .99 6SQ7GT .79 19B6G 2.49 83 .99 7V7 .99
 1T4 .89 H8G 1.59 6SR7M .79 1F8 1.49 84 2Z4 .99
 1TG1T .89 H8S .99 6SS7GT .99 22 78 .99 85 2Z4 .99
 1U4 .89 H8H .69 6SS7M .99 24A 79 85 .79 7Y4 .79
 1U5 .89 H8J .99 6SU7GT .99 25A6G .69 89 .79 7Z4 .79
 1V .49 H8K .89 6SZ7 .89 25A7GT .99 117L7 M7 14A4 .99
 1X2 1.49 H8A6 .99 6N7M 1.19 25B3G 1.99 117N7GT 14A7 .99
 1Y5GT .99 H8A7 1.19 6T7G 79 25C6 89 117N7GT 14A7 .99
 2A1 1.29 H8L5 1.19 6TR 1.69 25L6GT .89 14B6 .99
 2A3 .99 H8E6 .99 6U4 1.19 25W4 .99 117P7GT 14B8 .99
 2A6 49 H8F6 1.99 6U5 665 1.19 25Y5 89 2.29 14C5 .99
 2A7 .49 H8CGG 1.89 6U7G .69 25Z5 89 117Z3 1.39 14C6 .99
 2B7 .59 H8H 1.19 6V6GT 1.19 25Z6GT .89 117Z6GT 1.39 14E6 .99
 2A3 .99 H8A7 1.19 6W4GT .99 26 39 954 59 14E7 .99
 2X2 1.49 64 69 7 59 954 59 14F7 .79
 2X2 H79 79 65C5GT .79 6Y6G 1.19 31 59 956 59 14H7 1.19
 3A4 49 6C6 .59 6Z7 .49 32L7GT 1.49 3051 1.49 14J7 .99
 3A5 99 6C8G .59 6Z5 .49 32 1.49 5001 79 14K7 .99
 3A5 1.19 6C6 1.19 10Y .49 32 49 9002 79 14S7 .99
 3B7 1.21 49 6D6G 2.99 12A .69 33 49 9003 79 14W7 .99
 3D6 1.29 49 6C6 .99 12A5 .49 34 49 9007 79 14Y4 .99
 3Q4 69 6D7 .49 12A6 79 35 51 79 14A4 .99 14Y4 .99
 3Q5GT 1.19 6D8 49 12A7 .99 35A5 99 14A6 99 14Y4 .99
 3S4 .89 6C5 1.09 12A8GT 79 35B5 99 14B4 99 14Y4 .99
 3Y4 49 6S7GT .79 12AC5 89 35C5 99 14C5 99 14Y4 .99
 4T4M 1.19 6F6GT .99 12AL5 1.19 35L6GT .99 14C6 99 14Y4 .99
 5U4G 99 6F7 .99 12AH7 1.59 35W4 79 14D5 99 14Y4 .99

SPEAKER SPECIALS
Less Transformer Except as Noted

Net	Net
3" Alnico #5 Ea. \$1.25	6" 3" 1000 ohm Dynamic 1.39
In Carbons of 30 1.25	6" 3" 1300 ohm Dynamic 1.39
4" Alnico #5 Ea. \$1.25	6" 4" 1000 ohm Dynamic 1.39
In Carbons of 30 1.25	8" 4" 1000 ohm Dynamic 1.39
6" Alnico #5 Ea. \$1.75	8" 4" 1300 ohm Dynamic 1.39
In Carbons of 30 1.75	3" 3" 1000 ohm Dynamic49
6" 2 1/2" Alnico #5 Ea. \$1.25	AUTO SPEAKERS
In Carbons of 24 1.25	1 1/4" 4 ohm Dynamic 2.19
6" PM with 8" 6V6 Output 2.49	1 1/4" 8 ohm Less Output 4.95
6" 500 1 1/2" Alnico #3 Ea. \$1.49	6" 1 ohm Dynamic 2.25
8" 2 1/2" Alnico #5 Ea. \$1.75	8" 4 ohm Dynamic 2.25
10" 2 1/2" Alnico #5 Ea. \$2.25	8" 4 ohm Voice Coil 2.25
1 1/2" 3 ohm Voice Coil Ea. \$1.49	Less Output 2.25
2 1/2" 2 1/2" Mag. of Alnico Ea. \$1.75	8" PM Less Output 3.95

LINES CARRIED

- A. T. R. AMERICAN CORDS
- AMPERITE
- ANCHOR BOOSTERS
- ATLAS SOUND
- BIRNBACK
- BURGESS
- CAMEL IRONS
- CRESTOL
- CYCLE MASTER
- CYCLE TWIST
- DIALCO
- DUMONT TUNERS
- DUTCH BRAND
- EBY
- FICO
- ELECTRO-VOICE
- EXCELLITE
- EZ-LIGHT CLOCK
- G.E. LAMPS
- H. O. T.
- HOWARD SAMS
- HYTRON
- I. C. A.
- I. T. I. BOOSTERS
- JENSEN
- KRYLON SPRAYS
- LITELFUSE
- MERIT
- MOSLEY
- OAK RIDGE
- PHILLIPS
- QUAM
- R. M. S.
- RECOTON
- REGENCY
- RIDGELY JOHN F. PUBLICATIONS
- SARKES TARZIAN
- EBY
- SPRAGUE
- SQUARE ROOT
- STANWYCK
- STAR DRILLS
- STICKLEBACK
- TRILL SAW
- TRAY-ELECTRIC
- VACO PRODUCTS
- WALSCO

REGENCY TV SIGNAL BOOSTER Model DB 410



Installs simply . . . Single knob tuning control . . .
 Contra-Wound Bifilar Coils with push pull triode
 Electrical symmetry . . . No external impedances
 matching devices needed . . . Rich mahogany
 plastic cabinet with gilt floral panel. Underwriter's
 approval. YOUR NET COST \$19.11. LIST \$32.50.

GREYLOCK ELECTRONICS SUPPLY CO.
115 Liberty Street - New York 6, N. Y.

TERMS: Net C.O.D., F.O.B., N. Y. C. 10% deposit required on all C.O.D. orders. Dept. C-6

FREE—WRITE TODAY
 New Catalog Supplement #15
 All the latest merchandise—
 latest prices.
 Dept. C-6

TUBE — OHM — CAPACITY TESTER!

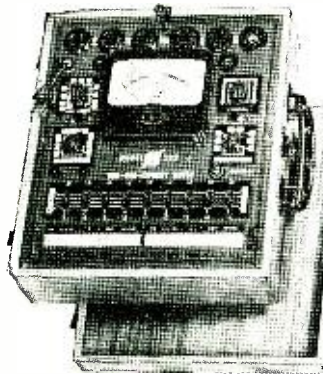

MODEL 203

- Line Voltage Control.
 - Pilot light indicator.
 - Checks shorts and leakages.
 - Checks resistance to 4 megs.
 - Checks capacity from .01 to 1 Mfd.
 - Checks condenser leakage to 1 megohm.
 - Individual sockets for every type tube base.
 - Built-in roll chart.
 - Tests tubes from .75 volts to 117 filament volts.
- Complete in sturdy, hand-rubbed portable oak case with carrying handle, **\$49.50**
ONLY

Add \$6.00 for 220V operation

Export Dept., 303 W. 42nd St., N. Y.
Write Dept. B-6 for Free Catalog

Gives More Measurement Value Per Dollar



**ELECTRONIC
MEASUREMENTS
CORPORATION**

280 Lafayette St., New York 12, N. Y.

FOR BETTER TOWERS AT LOWER COST! Ask about AERO

• COST LESS

Because Aero Towers are aircraft-designed, lower manufacturing costs offer you a lower price. Lower weight and lower shipping costs are passed on as savings to you.

• LAST LONGER

Coated INSIDE and OUT. DIP-COATED process keeps Aero Towers Bright and new. Rust resistant. Will not brown.

• EASY TO CLIMB AND SERVICE

Strong electric aircraft welds at EACH joint (not just one or two) prevents sway. Provides sturdy, safe, ladder-like cross members.

• QUICKER TO INSTALL

Aircraft precision tolerances assure accurate fit of components. Light and easy to erect. Strong durability assures customer satisfaction.

Jobber Territories Open
Dealers—Write for FREE booklet



AERO TOWER DIVISION
Knepper Aircraft Service
1018 Linden Street
Allentown, Pa.

ADVERTISING INDEX

Aero Towers Division	112
Allied Radio Corporation	57
Almo Radio Corporation	112
Amplifier Corporation of America	87, 96
Barry Electronics Corporation	107
Bell Telephone Laboratories	8
Boyce-Roche Book Company	60
Brooks Radio Dist.	90
Buchan, Richard J.	97
Buck Manufacturing Company	106
Buffalo Radio Supply	103
Capital Radio Engineering Institute	7, 98
Centralab—Div. of Glove Union	20, 21
Central Radio & TV Schools	107
Certified TV Laboratories	107
Cisin, H. G.	109
Clear-Vac Tube Company	101
Cleveland Institute of Radio Electronics	11
Coast Electronic Supply Company	108
Collins Audio Products Company	112
Commercial Trades Institute	87
Communications Equipment Company	108
Concord Radio Corporation	86
Cornell-Dubilier Elec. Corp.	14, 97
Coyne Electrical School	75, 102
D & H Distributing Company	84
DeForest's Training, Incorporated	9
Editors & Engineers	91
Electro Sales	89
Electronic Instrument Company	22
Electronic Measurements Company	92, 112
Feiler Engineering Company	101, 106
G & G Radio Parts Service	113
General Electronic Dist. Company	63, 99
General Industries Company	87
General Test Equipment Company	101
Gonset Company	74
Greylock Electronic Supply	111
Harvard Laboratories	84
Heath Company	68, 69, 70
Hudson Radio & TV Corporation	92
Hudson Specialties	105, 107
Hytron Radio & Electronics Corp.	59
I. D. E. A. (Inc.) Regency	66
Instructograph Company	89
JFD Manufacturing Company	75
Jensen Manufacturing Company	18
Jersey Specialty Company	82
La Pointe-Plascomold	19, 102
Leotone Radio Corporation	109
Long Island Radio Company	81
Mallory & Co., Inc., P. R.	Inside Back Cover
Merit Transformers Company	12
Midwest Radio & TV Corporation	74
Miles Reproducer Company	107
National Company	65
National Plans Company	109
National Radio Institute	3
National Schools	5
Niagara Radio Supply	79
Opportunity Adlets	106
Penn TV Products Company	84
Perfection Electric Company	96
Permotlux Corporation	73
Platt Electronics	105
Precision Apparatus Company	84
Prentice-Hall, Incorporated	88, 108
Pres-Probe Company	91
Progressive Electronics	76, 108
RCA Institutes	13
RCA Victor Division (Radio Corporation of America)	Inside Front Cover, Back Cover
Radcraft Publications, Inc.	92, 104
Radio City Products	81
Radio Corporation of America	85
Radio Dealers Supply	100
Radio Distributing Co.	106
Radio Publications	100

RADIO SCHOOL DIRECTORY (Page 110-111)

Baltimore Technical Institute	
Berkeley and Associates, Edmund C.	
Candler System Company	
Commercial Radio Institute	
Electronics Institute, Inc.	
Federal Electronics Institute	
Hollywood Sound Institute	
Hollywood Technical Institute	
Indiana Technical Institute	
Martin School, Don	
Milwaukee School of Engineering	
RCA Institutes	
Tri-State College	
Valparaiso Technical Institute	
YMCA Trade & Technical Institute	

Raytheon Manufacturing Company	6
Rider, John F.	77
Sams & Company, Inc., Howard W.	18, 95
Schott Company, Walter L.	15, 81, 83, 91
Sheldon Electric Company	61
Six-Thirty (630) Dist.	101
Sprague Products Company	4
Standard Transformer Corporation	83
Standard Wood Products Corp.	106

COLLINS FM TUNER



Model RD-1

A complete FM tuner covering 88 MC to 108 MC for custom installations and other high-fidelity applications.

Economically priced within the reach of all. • High sensitivity • No drift • Permeability tuning • Compact size 7" x 9" x 5".

NOTE: Chassis plate also available separately for installation in existing chassis. Completely aligned at factory. Order Model RD-1C for chassis plate only.

COLLINS AUDIO PRODUCTS CO.

P. O. BOX 368 WESTFIELD, N. J.

ALMO SPOTLIGHT SPECIAL



**WILCOX-GAY
RECORDETTE-3**

3-WAY, 3-SPEED
RECORDER-RADIO
PHONO-PORTABLE

YOUR COST **\$65⁷⁵**

• Play 12", 45, and standard records. Makes perfect demutator for record department. Built for heavy-duty and extra fine reproduction.

• Your record customers will like the Recordette 3. Plays and records all three speeds. Has quality superhet radio. Extremely light; weighs only 18 pounds.

10% Cash with Orders.

ALMO RADIO CO.

509 ARCH ST. & 6205 MARKET ST.
Philadelphia, Pa.
6th & ORANGE STS. • Wilmington, Del.
4401 VENTNOR AVE. • Atlantic City, N. J.
1133 HADDON AVE. • Camden, N. J.

Steve-El Electronics Corporation	80
Superior Instrument Company	16, 17
Sutton's Wholesale Electronics, Bill	108
Sylvania Electric Products	67
Technifax	103
Tel-A-Ray Enterprises, Inc.	99
Trio Manufacturing Company	98
Tung-Sol Lamp Works, Incorporated	10
Up-State Distributors	82
Ward Products Corporation	89
Weller Electric Corporation	78
Wells Sales Company	114
Wholesale Radio Parts Co., Inc.	107
World-Wide Packing & Shipping Company	106

RADIO-ELECTRONICS for

INDUSTRIAL! EXPERIMENTERS! Look at these terrific buys.

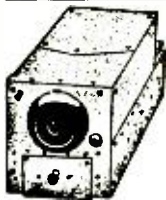

SMASH VALUES IN RADIO RECEIVERS AND TRANSMITTERS

BC 453	Revtr.	Used	\$17.95	New	\$35.00
BC 454	Revtr.	Used	9.95	New	16.50
BC 455	Revtr.	Used	8.95	New	11.95
BC 456	Mod.	Used	3.95	New	6.95
BC 457	Xmtr.	Used	7.95	New	12.95
BC 458	Xmtr.	Used	8.95	New	13.95
BC 459	Xmtr.	Used	16.95	New	29.50
BC 696	Xmtr.	Used	16.95	New	24.95

Dynamotor DM-32A 3.95



BC-645 XMTR RECEIVER 15 Tubes 435 To 500 MC

The electronic equipment that saved many lives in the war. Set can be modified to use for 2-way communication, voice or code, on following bands: ham band 420-450 mc, citizens radio 460-470 mc, fixed and mobile 450-460 mc, television experimental 470-500 mc. 15 tubes (tubes alone worth more than sale price!) : 4-7F7, 4-7H7, 2-7E6, 2-6F6, 2-955 and 1-WE316A. Now covers 460 to 490 mc. Brand new BC-645 with tubes, less power supply in factory carton. Shipping weight 25 lbs.

PE-101C DYNAMOTOR for above BC-645 \$3.95

UHF ANTENNA ASSY. for above BC-645 \$2.45

SETCHEL-CARLSON Beacon Radio Receiver BC-1206-C

Receives A N beam signals, operates on 21-28 V DC, 5 Tubes; 3-11H7, 14R7, 28D7. Tubes 195 to 120 Kc. Size 4"x4"x6 3/4" wide, 4 lbs. In original carton.



New **\$9.95**
Used **\$7.95**

11-TUBE SUPERHET RECEIVER Model BC-652-A-2000 to 6000 KC (75-80 Meters) BRAND NEW IN ORIGINAL CRATE SMASHING LOW PRICE

Complete with Crystal Tubes and Dynamotor.

For those of you "salters" in need of a good radio receiver aboard ship, the Model BC-652-A made by General Electric Co., will fill your needs! It is a rugged, good performing receiver which will give fine service for a long long time. This set is designed for 12/24 volt DC operation, which is ideal for shipboard use. It needs absolutely no conversion, just connect it into your batteries. Technically this set is an 11-tube superhet receiver with a freq range of 2000 to 6000 kc (75-80 meter ham bands), a crystal freq standard, and a 12/24 volt dynamotor, on two chassis combined into one case. The sensitivity is one microvolt or greater.

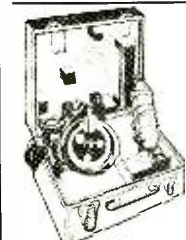

TERRIFIC VALUE BUBBLE SEXTANT

Actually worth \$100 or more! Has illuminated averaging disc for night-time use. Complete with carrying case, recording discs, flash light with rheostat for using sextant at night, 2X telescope for faint stars, and Allen **\$15.45** wrench. Only **\$15.45** Complete

OIL FILLED CONDENSERS		
2-mfd.—1000V	99c
4-mfd.—800V	1.25
4 x 4 mfd.—400V	1.05
3 x 3 mfd.—600V	1.10
2.5 mfd.—300V	89c
TRANSMITTING COND.		
02 mfd.—10,000V	3.25

FULL WAVE SELENIUM RECTIFIER

110V at 150 mil's **\$1.19**

JK-26 and PL 53 JAK & PLUG combination, for headset extension, etc.	Pair	35c
PL 53—Standard 2-circ. phone plug, fits all phone jacks.	Each	29c
PL 68—Standard 3-circ. mike plug, fits all 3-way mike jacks.	Each	22c

GE THYRATRON FG-105



Brand New MERCURY RECTIFIER

Individually boxed in factory sealed cartons. List Price \$60.00. Your cost **\$18.95** each. While They Last!

For continuous rectifier and welder control service. Tetraode type, indirectly heated cathode; 10000 V peak, 10000 V peak inverse. Av. Max. current 6.1 amps continuous, 2.4 to 4-amps welder control service.

SAVE ON THESE STANDARD TUBES

1H5GT	1.12	6L6G	1.65	12S17	.95
1LA4	1.45	6Q7	.75	12SK7	1.35
1L6A	1.45	6SA7	1.25	12SL7	1.10
1L84	1.45	6SC7	1.20	12SN7	1.75
1LC9	1.45	6SG7	1.10	12SQ7	1.25
1L6	1.45	6SF7	.97	12SR7	.90
1LD5	1.65	6S7	.95	12Z3	.85
1LE	1.45	6S7	.95	12Z5	.85
1LH4	1.45	6SL7GT	1.35	14B8	1.05
1LMS	1.35	6SRT7	1.65	14F7	1.20
1Q5GT	1.20	6S07	.90	14J7	1.35
1R5	1.20	6SS7	.95	14H7	1.10
1S5	1.00	6T7	1.20	14W7	1.35
1T4	1.10	6W4	1.50	14Q7	1.05
1V	1.25	6X5GT	1.25	14R7	1.25
1U4	1.10	7A4	2.20	25L6	.90
2A3	1.45	7A4	2.20	25Z6	.85
2A5	1.15	7A6	1.20	25Z6GT	1.2
2A6	.95	7A7	1.20	26	.65
2A7	.95	7B8	1.20	28D7	1.35
2B7	.95	7B4	1.20	30	.75
2K2A	.88	7B5	1.20	32	.55
30G5	1.10	7B6	1.20	33	.59
354	1.05	7B7	1.20	33	.55
3V4	1.05	7B8	1.20	35	.51
5A4	1.75	7C4	1.25	35A5	.90
5U4G	1.25	7C5	1.25	35A5	.90
5V4G	1.85	7C6	1.25	35B4	1.05
5W4	1.25	7D7	1.10	35C5	1.25
5X4G	1.10	7E6	1.10	35L6GT	1.25
5Y3GT	1.00	7F7	1.10	35W4	1.05
5Z4	.85	7G7	.90	35Y4	.95
5Z3	.95	7F8	2.15	35Z3	.88
5Z4	1.20	7H7	1.75	35Z4	.75
6A3	1.35	7K7	1.30	35Z5	1.20
6A6	1.25	7L7	1.30	36	.65
6A7	1.15	7N7	1.65	37	.65
6A8	1.10	7O7	1.00	38	.65
6AC5GT	1.30	7V7	1.30	39	.44
6AC7	1.90	7Y4	.90	41	.75
6AG5	1.90	11L7	M7	42	.75
6AH6	2.50			43	.82
6AJ5	1.65	11N7	1.70	45	.75
6AK5	2.60	11P7	1.70	46	.85
6AK6	1.90	11Z3	.85	47	.95
6AL5	1.65	11Z6	1.40	48	.95
6AL7	1.95	12A6	1.65	49	.95
6AQ5	1.75	12A6	.95	50A5	1.25
6AT6	1.30	12ARGT	.95	50B5	1.30
6AUG	1.70	12AH7GT	.95	50C5	.95
6AV6	1.30			50L6GT	1.25
6BA6	1.50	12AT6	1.30	50Y6	1.05
6B6	1.50	12B7	1.25	53	1.25
6B6GT	2.20	12A6	1.25	56	.70
6B8	1.75	12A7	1.95	57	.85
6C4	1.10	12A8	1.30	58	.85
6C6	.85	12AW6	1.90	59	1.75
6D6	.85	12B6	1.45	70L7	1.65
6E5	1.00	12C6	1.55	71A	.90
6F5	.80	12J7	.95	75	.75
6F6	1.20	12K7	1.05	77	.75
6F6GT	1.00	12K8	1.60	79	.75
6J5	1.25	12O7	.85	78	.75
6J6	1.25	12S4	1.10	82	1.35
6K6GT	1.15	12S7	1.60	83	1.25
6K7	1.25	12S7	1.00	85V	1.35
6L8	1.45	12S7	.90	84	1.90
6L6	1.95	12SH7	.95	85	1.05

183 1.40

DC AMMETER 0-15 Amps

A terrific buy! 3 1/2" easy reading scale, 75 divisions. Black plastic case 4 1/2" x 5 1/2" x 2 1/2". Rubber covered test clip leads plus black metal carrying case with hinged cover. Brand new. Wonderful for automotive, battery charging, general test work. Value \$25. All yours for **\$5.25** only.



SELVYN 2J1G1

Operates from 57 1/2 V 100 cycles. Suggested wiring for 110 V 60 cycle included. New, tested.



Price per pair **\$4.50**

BC 605 INTERPHONE AMPLIFIER

Easily converted to an ideal intercommunications set for office—home—factory. Complete w/conversion diagram for 110V operation.

BRAND NEW **\$4.95**

Please include 25% Deposit with order—Balance C.O.D. MINIMUM ORDER \$3.00. All Shipments F.O.B. Our Warehouse N.Y.C.

TERRIFIC VALUE 24-VOLT STORAGE BATTERY, BRAND NEW 17 AMP. HRS.

Made by Delco. 12 cells heavy duty, very rugged. Shipped dry, uses standard sulphuric acid electrolyte.



VERY SPECIAL **\$17.95**



6-VOLT STORAGE BATTERY
Navy Standard BRAND NEW. 15 ampere-hour rating **\$7.95**

ASTATIC R-3 CRYSTAL HANDMIKE

with 6-ft. R. C. Mike Cable **\$5.95**



ONE-QUART BOTTLE BATTERY ELECTROLYTE
Made by Willard, for above storage batteries. 1 quart sufficient for two 2-volt cells. Hermetically sealed. SPECIAL. per qt. bottle **\$1.45**

7-PRONG 2-VOLT RADIO VIBRATOR
for Portable and Farm Sets Replacement for GE LB 530 **\$1.95**



WILLARD 2-VOLT STORAGE BATTERY 20 Ampere-Hours

Exact replacement for GE portables for LB-500—BRAND NEW. Each **\$2.69**



WILLARD MIDGET 6-V STORAGE BATTERY

3 amp hour rating. Transparent plastic case. Brand new. 3 1/2" x 1 3/4" x 2 3/4" high. Uses standard electrolyte. Each **\$2.65**

HEADPHONES—All Brand New!

Individually packed, complete with phone plug. HS-33 600 ohms, in lots of 3 **3.95** each
HS-23 2000 ohms, in lots of 3 **3.25** each
HS-30 With earplugs, LOTS OF 12 **1.65** each

J. S. Army Field Phone Set EE-8

Leather case, with handset, generator, ringer, etc. Requires 2 flashlight cells. Wonderful value! Good Used, ea. ... **\$14.95**



W.E. BREAST MIKE

Single button carbon mike, with breastplate. Very sensitive, complete with 6-ft. cord and W.E. plug. SPECIAL. New **\$1.29**



HANDSET



Cradle-type handset with butterfly switch, unbreakable black plastic, 4-ft. 3 wire cable. BRAND NEW, individually packed. Each **\$7.50**

McElroy Automatic KEYER

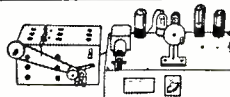

Suitable for keying transmitter, or for code practice. Has photocell and sensitive relay. Variable speed motor, 110V AC or DC. Complete with 2-117L6 and 1-117L6 tubes. your cost **\$21.00**

We Have Available **\$12.75** CODE PRACTICE TAPE

which was used for code practice work by the Signal Corps—from slow to fast practice. 15 rolls on 16MM metal reels in heavy wooden slotted case, to be used with McElroy TG10 Keyers, Tone Keyers or any code practice.

REQUIRE MAJESTIC
G & G RADIO PARTS SERVICE
53 VESEY STREET - NEW YORK 7, N.Y.

RELAYS

FOR EVERY PURPOSE

Over a Million in Stock!



Whether you require large quantities of relays for production runs or single units for laboratory or amateur work, Wells can make immediate delivery and save you a substantial part of the cost.

Our capable engineering staff is prepared to offer assistance in the selection of correct types to suit your exact requirements.

Each relay is brand new, standard make, inspected, individually boxed and fully guaranteed.

The following list represents only a tiny portion of our relay stock. Write or wire us for information on types not shown.

KEYING RELAYS

STK. NO.	VOLT-AGE	OHM-AGE	CONTACTS	UNIT PRICE
R-714	9/14 VDC.	65	2C 5 Amps.	\$1.55
R-653	12 VDC.	14	2C	1.55
R-721	18/21 VDC.	290	2C 5 Amps.	1.55
R-773	24 VDC.	280	3C 10 Amps.	1.60
R-694	24 VDC.	300	1A 5 Amps.	1.35
R-704	2/6 VDC.	25	2B 5 Amps.	2.80
R-297	1/5 VAC.	2	2C	1.55
R-173	2 6 VDC.	7	1A	2.45
R-280	6 8 VDC.	77	1A Double Break	1.45
R-647	6 12 VDC.	15	1B 20 Amps.	3.55
R-735	24 VDC.	160	2A 15 Amps. Dbl-Bk	2.70
R-169	24 VDC.	200	1B Double Break	2.70
R-570	24 VDC.	230	3C 10 Amps.	3.10
R-171	24 VDC.	230	2C	3.70
R-529	24 48 VDC.	1020	2C	1.30
R-715	24 VAC.	20	2C Ceramic	1.70
R-584	6 VDC.	20	1A Double Break	1.45
R-192	12 VDC.	44	3C 10 Amps.	1.45
R-204	12 VDC.	66	2A	1.45
R-224	12 VDC.	85	1A	1.45
R-221	18 24 VDC.	5000	1A	1.55
R-205	24 VDC.	260	2C	1.55
R-536	27 VDC.	230	2C	1.30
R-220	75 VDC.	5000	1C	1.55
R-627	115 VAC.	5000	1A Double Break	1.30
R-698	12 VDC.	75	1C	1.20
R-734	24 VDC.	150	3C 10 Amps.	1.30
R-598	28 VDC.	185	2C	1.30
R-622	20 30 VDC.	200	3A & 2C/10 Amps.	1.45
R-274	24 VAC.	...	2A	1.55
R-270	24 VAC.	...	1A	1.55
R-269	24 VAC.	...	1A 15 Amps.	1.55
R-277	12 VDC.	30	2C Dbl-Bk, Cera.	2.20
R-594	12 VDC.	50	2C	2.00
R-668	12 VDC.	50	1C 10 Amps.	3.10
R-613	12 VDC.	50	1C	1.30
R-772	12 VDC.	70	1A 15 Amps.	1.30
R-293	12 VDC.	150	1C Double Break	1.45
R-697	12 24 VDC.	100	1A 10 Amps.	2.45
R-580	12 24 VDC.	150	1C Double Break	1.45
R-276	24 VDC.	100	2C Dbl-Bk, Mica.	3.10
R-752	24 VDC.	150	2C 5 Amps.	1.45
R-768	24 VDC.	175	2A 5 Amps.	1.55
R-699	24 VDC.	200	3C 5 Amps.	1.55
R-700	24 VDC.	200	2C 8 Amps.	1.55
R-282	24 VDC.	325	1A Double Break	1.25
R-286	115 VAC.	950	2C	2.80
R-612	2 6 VDC.	1	1A	1.55
R-815	2/6 VDC.	1.5	1A/10 Amps.	1.55
R-263	6 VDC.	12	2C 15 Amps.	1.55
R-279	14 VDC.	250	1A/15 Amps. Dbl-Bk	1.55
R-278	18 24 VDC.	260	2C 1A, 1B	2.45
R-706	24 VDC.	150	4C 10 Amps.	2.95
R-177	24 VDC.	250	4C	2.45
R-609	250 VDC.	5000	1A Double Break	1.70
R-779	12 VAC.	...	1B 10 Amps.	1.55
R-272	24 VAC.	...	1A, 1B 5 Amps.	1.55
R-271	24 VAC.	...	2A, 1B 3 Amps.	1.55
R-685	115 VAC.	600	1A 6 Amps.	2.50
R-683	12 VDC.	40	2C/10 Amps.	1.30
R-757	12 VDC.	44	2C 1A Ceramic	1.45
R-152	12 VDC.	50	2C, 1B Ceramic	1.35
R-624	12 VDC.	50	1C	1.45
R-268	12 24 VDC.	260	3A, 1B	1.55
R-805	18 VDC.	200	1A/10 Amps.	1.30
R-644	18 24 VDC.	275	1A 25 Amps. & 1A/5A	2.45
R-687	26.5 VDC.	125	2C 15 Amps. & 3A/10A	1.45
R-674	24 VDC.	250	1C 5 Amps.	1.45
R-593	28 VDC.	125	2C 10 Amps.	1.50
R-191	28 VDC.	125	2C 10 Amps. Ceramic	1.50
R-248	28 VDC.	150	1A 20 Amps.	1.30
R-615	32 40 VAC.	...	3A 15 Amps.	1.55

STK. NO.	VOLT-AGE	OHM-AGE	CONTACTS	UNIT PRICE
R-582	120 VAC.	...	1A	2.45
R-812	115 VAC.	...	1A Dbl-Bk, 15A	2.45
R-260	115 VAC.	500	3A 15 Amps.	2.80
R-249	135 VAC.	600	2A Ceramic	2.80
R-665	115 VAC.	500	2B 10 Amps.	2.80
R-693	2 6 VDC.	125	1C 3 Amps.	1.10
R-597	4 12 VDC.	15	1A 25 Amps.	2.45
R-193	5 8 VDC.	11	2C, 1A, 10 Amps.	1.30
R-595	5 8 VDC.	18.5	3C	1.30
R-692	6 24 VDC.	1280	1C 3 Amps.	1.35
R-793	12 VDC.	42	2C 10 Amps.	1.55
R-599	12 VDC.	67	3A 15 Amps.	1.45
R-559	24 VDC.	93	1A 10 Amps. & 1A 20A's.	1.30
R-560	24 VDC.	160	1A	2.00
R-795	24 VDC.	160	2A 10 Amps.	1.55
R-796	24 VDC.	160	2A 15 Amps.	2.80
R-562	24 VDC.	160	4A 10 Amps.	1.60
R-797	24 VDC.	160	8A 8 Amps.	2.80
R-349	24 VDC.	160	1C 10 Amps.	1.55
R-758	24 VDC.	160	2C 10 Amps.	1.55
R-242	24 VDC.	170	1C 20 Amps.	1.55
R-675	24 VDC.	180	2A/10 Amps.	1.50
R-649	24 VDC.	265	1A	1.30
R-744	24 VDC.	265	1A 20 Amps.	1.50
R-530	24 VDC.	265	2A 10 Amps.	1.45
R-574	24 VDC.	265	2B	1.30
R-791	24 VDC.	375	2C 10 Amps.	1.30
R-775	28 VDC.	180	2C Ceramic	1.55
R-776	28 VDC.	265	2A	1.70
R-701	28 VDC.	425	2B 10 Amps.	2.80
R-802	24 VDC.	160	3A Dbl-Bk, 15 Amps.	2.80
R-792	24 VDC.	200	1A 15 Amps.	2.40
R-798	24 VDC.	500	1C 5 Amps.	2.40
R-695	12 VDC.	70	2C 3 Amps.	1.30
R-288	18 24 VDC.	175	2A Ceramic	2.20
R-558	24 VDC.	280	2C 3 Amps.	1.55
R-299	6 VDC.	24	2A	1.55
R-267	12 VDC.	65	2C 5 Amps.	1.55
R-206	24 VDC.	150	5C	1.30
R-207	24 VDC.	210	4C	1.35
R-219	50 VDC.	1500	2A 15 Amps.	1.55
R-551	12 24 VDC.	80	2A 10 Amps.	1.50
R-506	24 VDC.	300	2A 6 Amps.	1.20
R-581	24 VDC.	4500	1A 5 Amps.	1.20
R-825	115 VAC.	...	1A 6 Amps.	2.45
R-819	115 VAC.	...	2A 6 Amps.	2.45
R-652	115 VAC.	...	1A Dbl-Bk/20 Amps.	2.80
R-217	115 VAC.	...	1C	2.80
R-824	2 VDC.	75	1C	1.55
R-802	8 12 VDC.	5000	1C	2.80
R-820	10 VDC.	20	1B Dbl-Bk 6 Amps	1.30
R-821	18 VDC.	2000	1A, 1B 2 Amps.	2.45
R-587	24 VDC.	160	2C 10 Amps.	1.55
R-739	24 VDC.	200	1A	1.30
R-724	75 VDC.	2200	2B 3 Amps.	2.40
R-823	110 VDC.	5000	1B	2.45
R-617	12 VDC.	600	1C Double Break	1.25
R-729	12 VDC.	80	1A 10 Amps.	1.25
R-722	24 VDC.	300	1A 10 Amps.	1.30
R-577	48 VDC.	220	2C	2.45

MIDGET RELAYS

STK. NO.	VOLT-AGE	OHM-AGE	CONTACTS	UNIT PRICE
R-572	24 VDC.	256	1C	\$1.25
R-291	6 VDC.	5	1A	1.25
R-738	12 VDC.	60	3A	1.20
R-144	12 VDC.	228	1A	1.45
R-145	18 24 VDC.	250	2A Ceramic	1.45
R-298	21 VDC.	300	1A	1.25
R-295	21 VDC.	300	1A	1.25
R-586	21 VDC.	300	1A & 1C	1.25

STK. NO.	VOLT-AGE	OHM-AGE	CONTACTS	UNIT PRICE
R-137	24 VDC.	300	1C	1.45
H-142	24 VDC.	400	2C	1.50
R-785	24 VDC.	200	2C/10 Amps.	2.00
R-607	24 VAC.	...	1A	1.20
R-806	24 VAC.	...	1A & 1B	1.20
R-605	24 VAC.	30	3A	1.20
R-728	6 VDC.	30	1A	1.25
R-807	6 VDC.	30	2C	1.25
R-625	6 VDC.	45	1C 3 Amps.	1.25
R-732	12 VDC.	120	1A	1.50
R-733	12 VDC.	120	2C	1.50
R-281	12 VDC.	126	2A	1.25
R-818	24 VDC.	300	1B	1.25
R-139	24 VDC.	2.45	4C	1.45
R-135	24 VDC.	250	1B	1.45
R-133	24 VDC.	300	None	1.55
R-138	24 VDC.	300	4A	1.45
R-132	24 VDC.	300	2C	1.50
R-731	24 VDC.	300	2C	1.55
R-730	24 VDC.	500	2C & 1A	1.55
R-292	24 VDC.	350	1C	1.25
R-626	24 VDC.	400	1A/5 Amps.	1.55
R-786	60 VDC.	1300	2C	2.00
R-588	125 VDC.	6500	4A	2.70
R-132	24 VDC.	300	1C	1.45
R-150	6 VDC.	30	1A	1.20
R-640	24 VDC.	330	1C/3 Amps.	1.20
R-148	12 VDC.	100	2C & 1B	1.35
R-285	12 VDC.	75	3A	1.35
R-222	12 VDC.	100	2A	1.21
R-659	6 VDC.	20	3C/3 Amps.	1.45
R-696	24 VDC.	230	1A/8 Amps.	2.00
R-143	24 VDC.	280	1C	1.45
R-141	24 VDC.	280	3A	1.45
R-140	24 VDC.	280	1C	1.45
R-590	24 VDC.	300	2B	1.25
R-540	24 32 VDC.	300	2C	1.50
R-543	24 32 VDC.	300	4C	1.50
R-743	110 VDC.	5000	3B & 1A	2.65
R-783	100 VDC.	5000	1C Micalex.	2.40
R-782	100 VDC.	6500	4C & 1A	2.45

SPECIAL RELAYS

STK. NO.	VOLT-AGE	OHM-AGE	CONTACTS	UNIT PRICE
R-503	12 32 VDC.	100	3A, 2C	2.80
R-749	600 VDC.	...	Max. 28 Amps.	7.45
R-804	550 VAC.	...	1B/38 Amps.	4.35
R-250	115 VAC.	...	Adj. Cir. Br.--.04-.16A	17.50
R-579	220 VAC.	...	1B	8.70
R-294	27.5 VDC.	200	1B	5.35
R-686	115 VAC.	...	2C	6.10
R-246	115 VAC.	...	1B	11.20
R-246A	115 VAC.	...	1A	11.20
R-611	24 VAC.	...	1A/30 Amps.	5.35
R-283	12 VDC.	125	1C/10 Amps.	1.25
R-614	18 24 VDC.	60	1A/15 Amps.	4.35
R-262	1C	4.70
R-245	12 VDC.	25	4" Micalex Lever	1.29
R-527	6/12 VDC.	50/50	In Series	1.20
R-544	12 24 VDC.	60/60	1C	2.05
R-255	1A	1.20
R-669	75 VAC.	400 Cy	3" Stroke	1.20
R-660	6 VDC.	...	3" Stroke	1.20
R-651	24 VDC.	100	Solenoid Valve	3.10
R-295	12 VDC.	275	Annunciator Drop	2.70
R-230	5 8 VDC.	2	2A, 1C	2.70
R-813	12 VDC.	12	Water	5.35
R-275	12 VDC.	750	1A, 1B, 1C	3.45
R-716	24 VDC.	70	2A 5 Amps.	1.60
R-620	6/12 VDC.	35	2C, 1A	1.30
R-629	9/14 VDC.	40	1C/10 Amps.	1.55
R-720	24 VDC.	50	2C Ceramic	1.70
R-500	12 VDC.	10/10	2C/6 Amps.	3.55
R-816	12 VDC.	10/15	2C/6 Amps.	3.55
R-524	24 VAC DC.	...	2C/6 Amps.	1.20
R-566	115 VAC.	Coil only	...	1.00
R-710	150 VDC.	Coil only75
R-811	48 VDC.	8000	1C	2.05

BASIC CONTACT ASSEMBLIES SHOWN IN UNOPERATED NORMAL POSITION

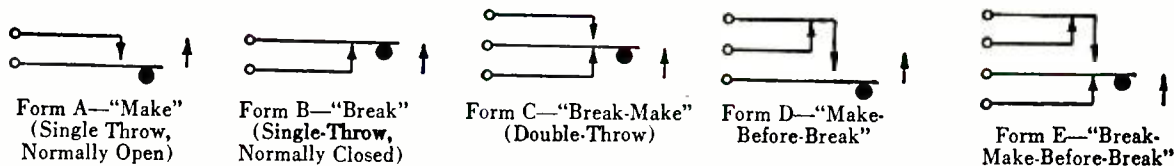

**WRITE FOR
WELLS CATALOG**

TELEPHONE

Seeley 8-4143

**WELLS
SALES, INC.**

Don't gamble with comebacks!

Hundreds of servicemen, interviewed in a recent survey, say that to avoid comebacks they use Mallory Vibrators. For right-the-first-time jobs, their rule is . . .



Make Sure! Make it Mallory!

We called on every serviceman in the phone book—in widely scattered cities—talked to every one we could find in his shop. We found that servicemen prefer Mallory vibrators in a ratio of two to one over any other brand!

Why? Better performance! Longer life! Less service trouble!

Mallory vibrators give you the performance you want because of experience dating back to the first commercial vibrator development—because of a patented design that gives you positive starting, quiet operation, long life. Mallory gives you a better vibrator, available in a complete line, meeting original equipment specifications . . . and you pay no more.

Don't just order vibrators. Order Mallory! Get the benefit of the precision quality that is the reason for more Mallory vibrators being used in original equipment than all other makes combined.

Depend on your Mallory Distributor for precision quality at competitive prices.

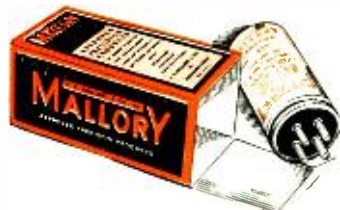

P. R. MALLORY & CO. Inc.
MALLORY

CAPACITORS • CONTROLS • VIBRATORS • SWITCHES • RESISTORS
• RECTIFIERS • VIBRAPACK* POWER SUPPLIES • FILTERS

*Reg. U. S. Pat. Off.

APPROVED PRECISION PRODUCTS

P. R. MALLORY & CO., Inc., INDIANAPOLIS 6, INDIANA

THE QUALITY OF RCA TUBES IS UNQUESTIONED

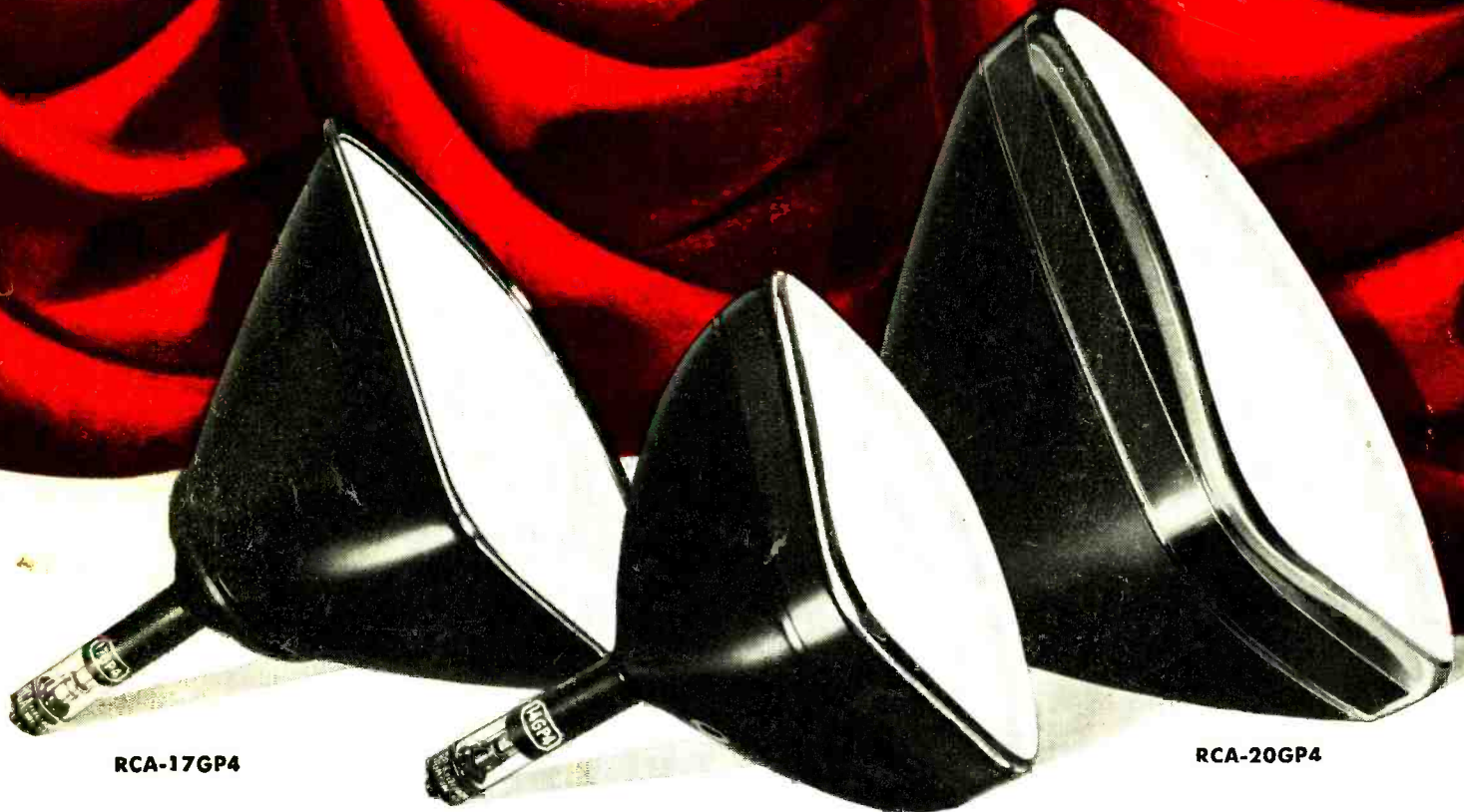

RCA-17GP4

RCA-14GP4

RCA-20GP4

ANOTHER IMPORTANT RCA

Engineering Advance...

Electrostatic Focusing

for television picture tubes

... and how it will benefit you



Once again, RCA engineering has made an important technical advance that benefits the entire industry—by developing an improved method of electrostatic focusing. Electrostatic focusing has now been incorporated in three new RCA rectangular kinescopes.

The new tubes require no focusing coil or focusing magnet. They provide pictures of the same high quality obtained from magnetic-focus types.

It will be a while before you as a dealer or a serviceman will have occasion to stock these electrostatic-focus kinescopes. But . . . because these tubes permit important savings in critical materials, manufacturers can produce more television receivers upon which your future business will depend.

In the meantime, RCA is producing sufficient quantities of its magnetic-focus kinescopes to meet your current replacement requirements.

Keep informed... stay in touch with your RCA Tube Distributor



RADIO CORPORATION of AMERICA
ELECTRON TUBES

HARRISON, N. J.

ADV Plans, LLC

Copyright Notice:

The entire contents of this CD/DVD are copyright 2014 by ADV Plans, LLC. All Rights Reserved.

Reproduction or distribution of this disk, either free or for a fee is strictly prohibited. We actively monitor and remove listings on eBay thru Vero.

You are free to copy or use individual images in your own projects, magazines, brochures or other school projects.

Only the sellers listed here are authorized distributors of this collection:
www.theclassicarchives.com/authorizedsuppliers

Please view our other products at
www.theclassicarchives.com,
or our ebay stores:

[TheClassicArchives](#)
[ADVPlans](#)
[SuperShedPlans](#)

